

BUSHCRAFT

A SERIOUS GUIDE TO SURVIVAL
AND CAMPING

by Richard Graves

You can
survive in the
wilderness with
only a knife and
this book!

PHOTOGRAPHY BY STEVE HARRIS

RICHARD GRAVES

AUSTRALIAN BUSHCRAFT

A serious guide to survival and camping

Illustrated by Richard Gregory

DYMOCKS

CAMBERWELL-WAVERLEY REGIONAL LIBRARY

1 089637 03

796.5
GRA

Devised and produced by Taylor-Type
Publications (Australia) Pty Ltd
This revised and updated edition
published in 1984 by
Dymocks Publishing Pty Ltd
12 Clearview Place, Brookvale, NSW 2100

© Richard Graves 1984

This book is copyright. Apart from
any fair dealing for the purposes
of private study, research, criticism
or review, as permitted under the
Copyright Act, no part may be
reproduced by any process without
written permission. Inquiries should
be addressed to Dymocks Publishing Pty Ltd.

National Library of Australia
Cataloguing-in-Publication data
Graves, Richard, 1898-1971.

Australian bushcraft.

Previously published as: The 10
bushcraft books. Sydney, Dymocks 1970.
ISBN 0 909824 35 5.

1. Outdoor life – Australia. 2. Camping –
Australia. 3. Hiking – Australia.
4. Wilderness survival – Australia.

I. Gregory, Richard. II. Graves, Richard,
1898-1971. The 10 bushcraft books.

III. Title. IV. Title: The 10 Bushcraft books.

796.5

Designed by M. D. Camp
Typeset by Everysize Typeart, Sydney
Printed in Hong Kong

Contents

Introduction	7
1 Ropes and cords	9
2 Knots and lashing	43
3 Huts and thatching	70
4 Campcraft	108
5 Food and water	173
6 Fire making	225
7 Animal habits	249
8 Travel and weather	268
9 Time and direction	290
Bibliography	316
Index	318

Introduction

Richard Graves, who died in 1971, first published *The 10 Bushcraft Books* in 1950. A cousin of poet and author Robert Graves, he was an enthusiastic bushwalker, skier and a pioneer of white-water canoeing. During the Second World War he realised that knowing the bush helped to save lives, particularly those of men stranded behind enemy lines in the island jungles of the Pacific zone. He founded and led the Australian Jungle Rescue Detachment, assigned to the Far East United States Air Force. This detachment of 60 specially selected A.I.F. soldiers successfully carried out more than 300 rescue missions during the period of the war. Most of these missions were in enemy-held territory. All were successful, and no lives were lost.

The key to the success of these rescue missions in wild and inhospitable country was survival. It was then, during the jungle training school period, that he started to compile the notes for the original 10 bushcraft volumes.

Graves later revised the notes and after the war conducted a school in bushcraft for almost twenty years.

In his introduction to the collection of these books Graves stated:

‘The practice of bushcraft shows many unexpected results. The five senses are sharpened and consequently the joy of being alive is greater.

‘The individual’s ability to adapt and improvise is developed to a remarkable degree. This in turn leads to increased self-confidence.

‘Self-confidence and the ability to adapt to a changing environment and to overcome the difficulties is followed by

a rapid improvement in the individual's daily work. This in turn leads to advancement and promotion.

'Bushcraft, by developing adaptability, provides a broadening influence, a necessary counter to offset the narrowing influence of modern specialisation.

'For this work of bushcraft, all that is needed is a sharp cutting instrument: knife axe or machete. The last is the most useful. For the work, dead materials are most suitable. The practice of bushcraft conserves and does not destroy wildlife.'

1 Ropes and cords

One of the basic skills needed in bushcraft is the ability to join or tie poles or sticks together. The only method available is to use lashings. Although the ready availability these days of cheap lightweight and extremely strong nylon ropes have made their inclusion almost automatic in any 'survival' bush kit, emergencies can arise. Under these circumstances ropes made from bush materials can be the key to survival.

The ability to spin or plait fibres into ropes or cords is one of the oldest of all primitive skills. The basic method is simple and has remained unchanged for thousands of years.

You can find the material from which to spin or plait ropes or cords almost anywhere in the bush. Any fibrous material which has reasonable length, moderate strength and is flexible or pliable can be used. These three properties are the ones to look for when selecting materials. They can be found in many vines, grasses, barks, palms and in the hair of animals.

The breaking strain of handmade ropes and cords varies greatly with different materials. Because of this variation it is essential that the rope or cord be tested before being actually put to use.

The list of uses to which handmade ropes and cords can be put is almost endless.

The making of ropes and cords

Almost any natural fibrous material can be spun into good, serviceable rope or cord. Many materials which have a length of 30 to 60 cm or more can be plaited or braided.

Ropes of up to 5 and 10 cm diameter can be 'laid' by four people, and breaking strains for bushmade rope of 5 cm diameter range from 50 kg to as high as 1000 kg.

BREAKING STRAINS Taking a three-lay rope of 3 cm diameter as standard, the following list of breaking strains gives an idea or guide to the general strengths of various bush materials. For safety's sake always regard the lowest figure as the actual breaking strain unless tests have shown otherwise.

Green grass	50 - 100 kg
Bark fibre	200 - 700 kg
Palm fibre	300 - 1000 kg
Sedges	900 - 1000 kg
Lianas (monkey vines)	250 - 300 kg
Lawyer vine (<i>Calamus</i>)	500 kg
	(10 mm diameter, unskinned)

PRINCIPLES OF SELECTING ROPE-MAKING MATERIALS To discover whether or not a material is suitable for rope-making it must have four essential qualities.

- It must be reasonably long in the fibre
- It must have strength
- It must be pliable
- It must have adhesion or grip so that the fibres will bite into one another

There are three simple tests to find out if any material is suitable.

First pull on a length to test it for strength. If it does not immediately snap or pull to pieces, it should be twisted between the fingers and the fibres should be rolled together. If it will stand this and not snap apart, tie a knot in the material and slowly and gently tighten it. If the material does not cut in on itself and you can pull the knot reasonably tight, it is suitable for rope-making, providing it will bite or grip together and does not slip apart instantly.

You will find these qualities in all sorts of plants; in ground vines, in most of the longer grasses, in some of the water

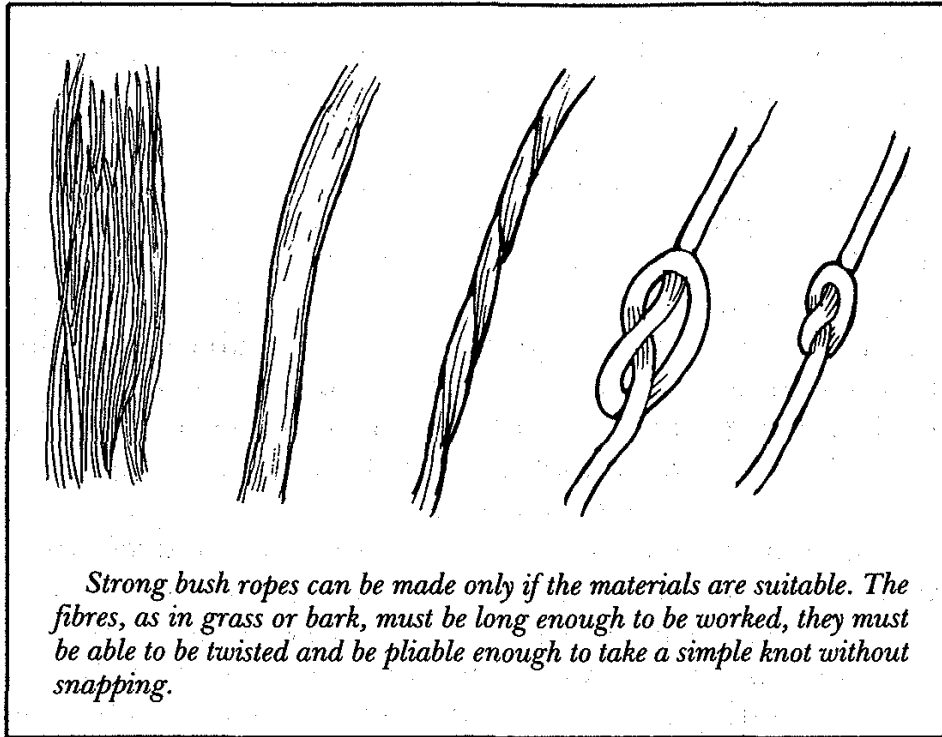

weeds and rushes and in the inner bark of many trees and shrubs.

Some green, freshly gathered materials may be stiff or unyielding. However, they still may be suitable for rope-making. Pass them over the flames of a hot fire for 30 seconds or so. The heat will often cause the sap to burst through some of the cell structures making the material pliable.

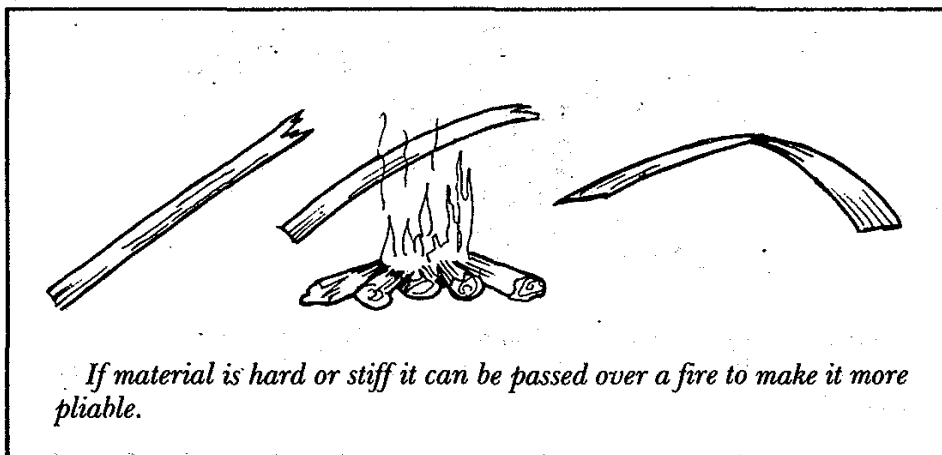

Apart from fibre sources in the plants mentioned above some seaweeds can be useful sources for rope-making material as can members of the large aloe family.

GATHERING AND PREPARING MATERIALS In some plants there may be a high concentration of vegetable gum. This can often be removed by soaking in water (such as the back-eddy of a stream or in a waterhole) for several hours until the material is cleaned. A running stream is suitable only if the material can be anchored or secured. Large stones are useful for this. If large enough containers are available the material can be boiled. A third method is to dry it out thoroughly in the sun and then tease the fibres out.

Some materials have to be used green if any strength is required. Those that should be used green include the sedges, water rushes, grasses and liana vines. Grasses, sedges and water rushes should be cut and never pulled out of the ground. Cutting above ground level with a sharp knife or

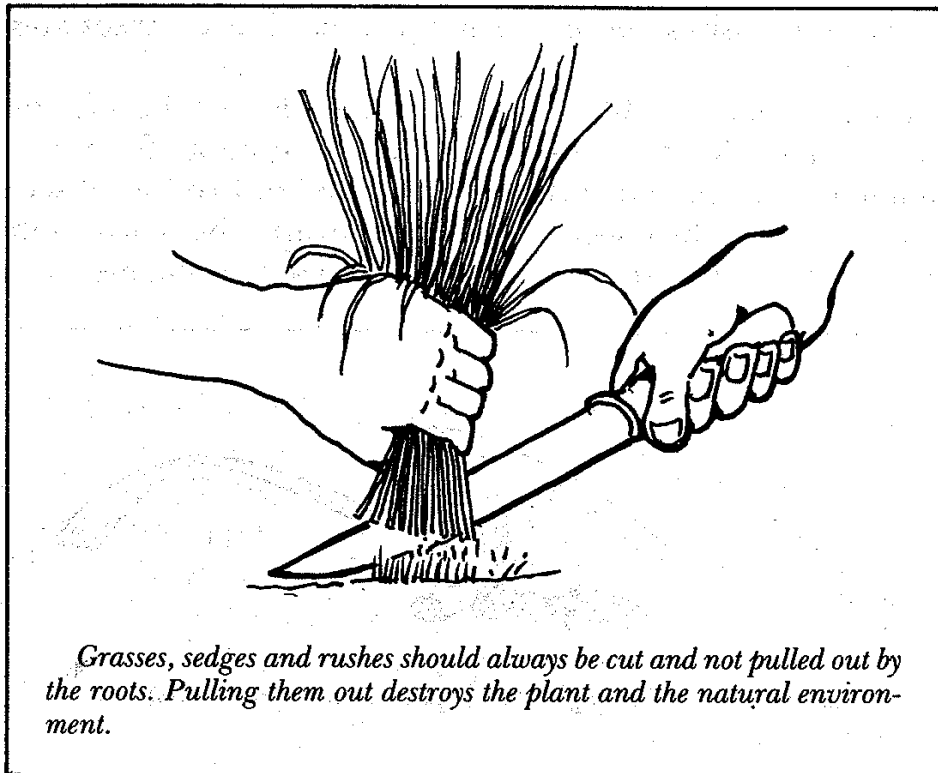

machete is harvesting. But pulling it out destroys the root structure and kills the plant.

When harvesting, work over as wide an area as possible. Do not completely clear any one site. Remember to leave at least some stands of the plant to go to seed to allow for regrowth. Thus with the sedges and grasses be particularly careful with your harvest. Cut what you require above ground level and take only from the biggest clumps.

Palm fibre in tropical or sub-tropical regions used to be regularly harvested as a matter of course and was put to many uses. It is found at the junction of the leaf and the palm trunk. It can also be found lying on the ground beneath many species of palm. It is one of the best rope- and cord-making materials available.

The lawyer vine or *Calamus* must be approached with some caution. Normally found in the rainforest areas of northern Queensland it can also be obtained (although it is rarer) in similar areas in the southern part of that State and in northern New South Wales. The leaves of the lawyer vine have needle-like prickles and the 'branches' are armed with sharp hooks — once much used by the Aborigines to catch fish.

Once the difficult process of stripping off the leaves and the hooks themselves is completed, the lawyer vine, if the outer bark is not removed, will be found to have enormous strength. In the past it has been used for making cables to haul logs, as rigging for boats, in suspension bridges and in the making of fish traps and baskets.

In favourable circumstances individual vines up to 100 metres in length are not uncommon.

In temperate areas fibrous matter from the inner bark of certain trees and shrubs is an excellent source of rope-making material. It is most suitable when the tree is dead and the material has dried out. The inner bark of many eucalypts possess this useful fibre. If the tree is dead when the fibre is teased and separated the natural gum will have dried out and will separate from the material as a fine powder.

Do not use the bark from green trees or shrubs unless it is

absolutely essential; even then cut off branches rather than fell the whole tree. Never cut down a complete tree simply because you want some of its bark for a length of cord.

If there is no alternative to green timber, test before you cut. Slice a small section about 10 cm in length and about 5 cm wide from the selected branch. This sample should be cut through to the sapwood. Peel it off the tree and then test the different layers. If it is not oozing gum it probably will be suitable; but it should still be soaked in water for some time and then sun dried.

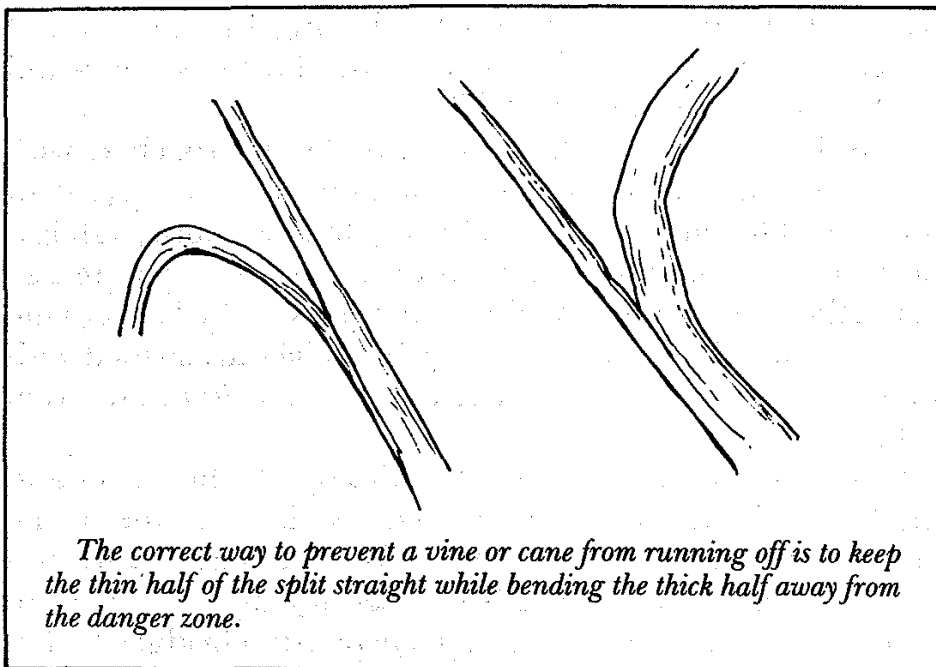

In the case of green lianas and vines only the outer skin is usually strong. This will split off easily if the main stalk is bent away from the skin. This principle applies to palm leaf stalks and most other green material. If a split starts to run off, the material must be bent away from the thin side. It will then gradually gain in size and come back to an even thickness with the other split side.

TO MAKE CORD BY SPINNING WITH THE FINGERS Use any material with long, strong threads or fibres which have been tested

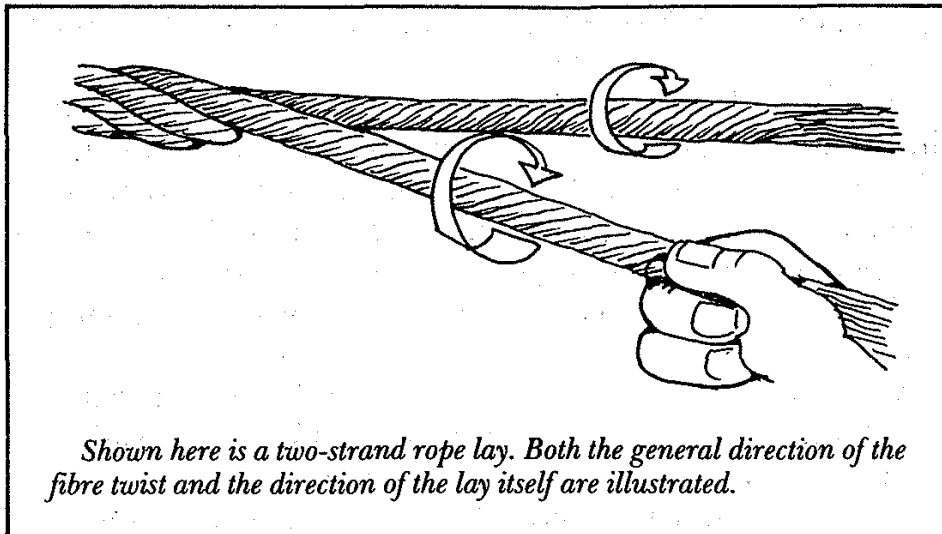

previously for strength and pliability. Gather the fibres into loosely held strands of even thickness. Each of these strands is twisted clockwise. The twist will hold the fibre together. The strands should be from 1 mm downwards — for a rough and ready rule there should be about 15 to 20 fibres to a strand. Two, three or four of these strands are later twisted together and this twisting together or 'laying' is done with an anti-clockwise motion, while at the same time the separate strands which have not yet been laid up are twisted clockwise. Each strand must be of equal twist and thickness.

The person who twists the strands together is called the 'layer'. He must see that the twisting is even, that the strands are uniform and that the tension on each strand is equal.

In laying he must watch that each of the strands is evenly 'laid up', that is, that one strand does not twist around the other two. This invariably happens the first time rope-making is attempted. It should be stressed here that rope-making is a skill that is not acquired at one go.

When spinning fine cords for such things as fishing lines, considerable care must be taken to keep the strands uniform and the lay even. Fine thin cords capable of taking a strain of up to 10 kg can be made by the experienced spinner but not by the beginner.

Normally two or more people are needed to spin and lay

up the strands for cord. It is a community effort, in other words.

Some people, when spinning cord, do so unaided, twisting the material by running the flat of the hand along the thigh, with the fibrous matter between hand and thigh. With their free hand they feed in fibre for the next spin. By this means one person can make long lengths of single strands.

However, this method is slow if any considerable length of cord is required.

A simpler and easier way to make lengths of rope from 50 to 100 metres or more in length is to make a ropewalk and set up multiple spinners in the form of cranks.

In a ropewalk each feeder holds the material under one arm and with one free hand feeds it into the strand which is being spun by the crank. The other hand lightly holds the fibres together until they are spun. As the lightly spun strands are increased in length they must be supported on cross lays. They should not be allowed to lie on the ground.

Strands of between 20 and 100 metres can be spun before laying up. Do not spin the material too thickly. Thick strands do not help strength in any way; rather they tend to make a weaker rope.

Setting up a Ropewalk

When spinning ropes of 10 metres or longer it is necessary to erect crossbars every 2 or 3 metres to carry the strands as they are spun. If crossbars are not set up the strands or rope will sag to the ground and some of the fibres will entangle themselves with grass, twigs or dirt. The sagging can also either interrupt or stop completely the twisting of the free end. The strand then will be uneven or lumpy.

The easiest way to set up crossbars for the ropewalk is to drive pairs of forked stakes into the ground at the required intervals. The crossbars must be smooth and free from twigs and loose bark that can jam the spinning strands.

Looking at the illustration overleaf, the crossbar A is supported by two uprights and pierced to take the cranks, B.

These cranks can be made out of natural sticks, morticed slab and pegs, or, if available, thick bent wire. The connecting rod, C, enables one man to turn all cranks clockwise simultaneously. Crossbars supporting the strands as they are spun are shown in fig.D. A similar crank handle to C is supported on a forked stick at the end of the rope walk. This handle is turned in a reverse direction (ie. anti-clockwise) to the crank, C, to twist the connected strands together. These are laid up by one or more of the feeders.

Always make it a rule to turn the first strand clockwise. Then the laying up of the strands will be done anti-clockwise and the next laying will again be clockwise.

If your rope is well made the individual fibres will lie lengthways along the rope.

In the process of laying up the strands the actual twisting together or laying will take some of the original 'twist' out of the strand which has not yet been laid. Therefore it is necessary to keep twisting the strands while laying together.

When making a rope too long to be spun and laid in one piece, a section is laid up, and coiled on the ground at the end of the ropewalk furthest from the cranks. Strands for a second length are spun and these strands are married or spliced into the strands of the first section. Then the laying up of the second section continues the rope.

The actual marrying of the strands is done only in the last lay which, when completed, makes the rope. The ends where the strands are married should be staggered in different places. By this means rope can be made and extended in sections to a great length.

After the complete length of rope is laid up pass it quickly through a fire to burn off loose ends and fibres. This will make it smooth and professional looking.

LAYING THE STRANDS The strands lie on the crossbars as they are spun. When they have been spun to the required length, which should be no more than about 25 metres, they are joined together by being held at the far end. They are then ready for laying together.

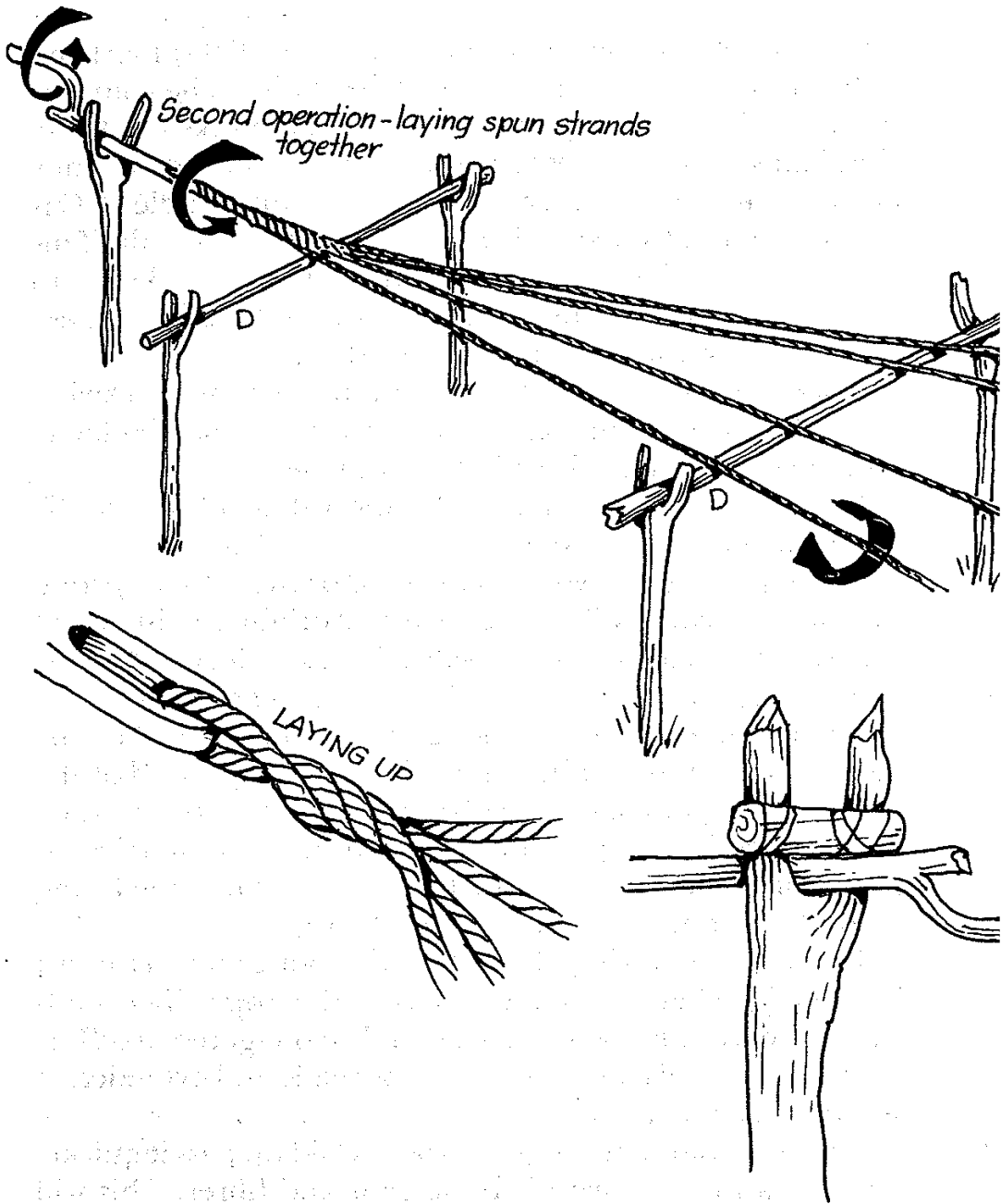

Construction of a bush ropewalk showing supports, rope rests, different types of spinners and the method by which the strands are laid up.

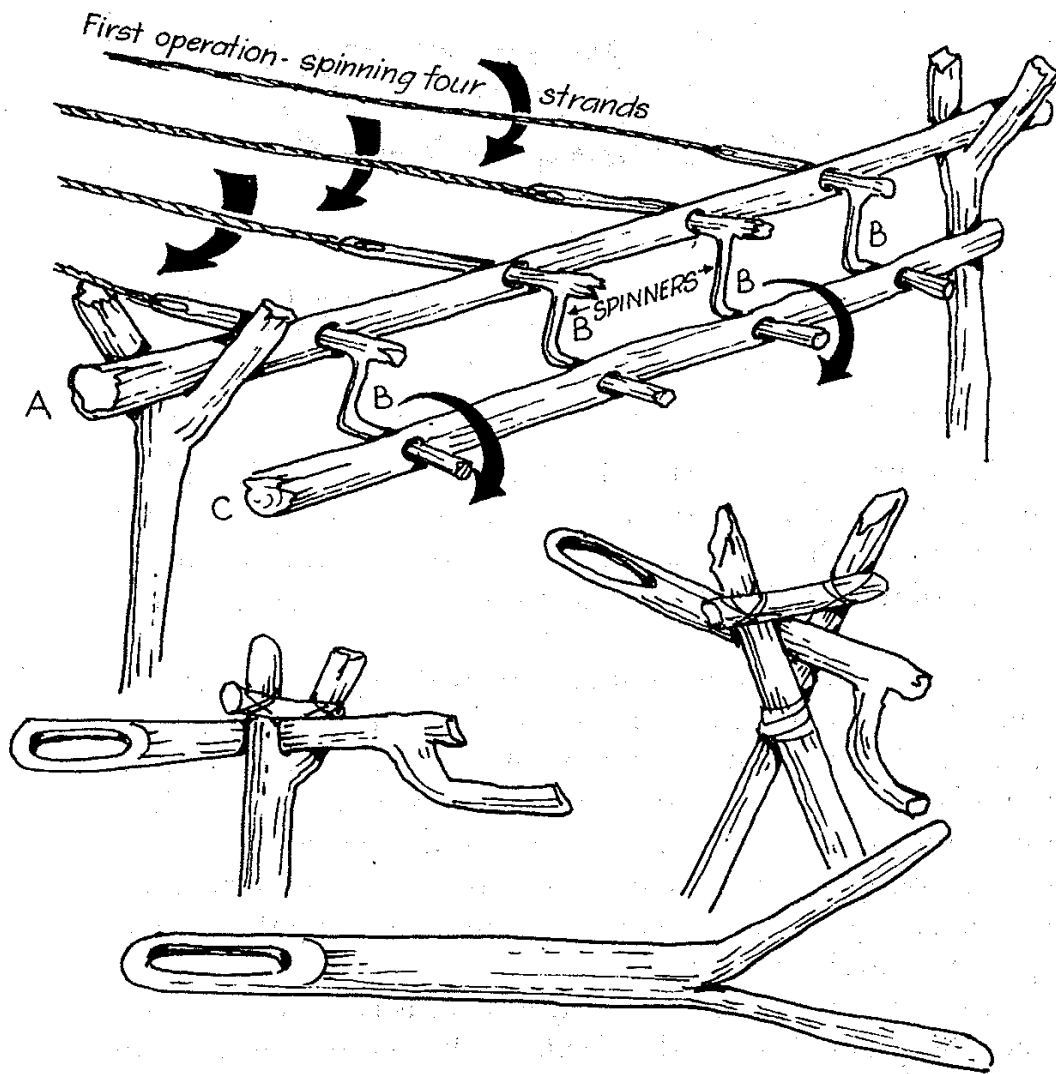
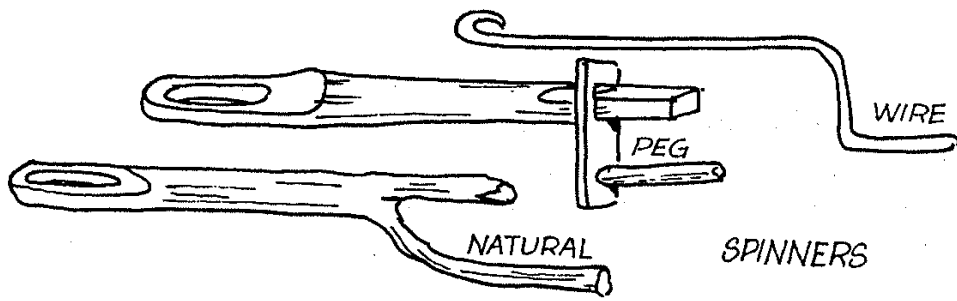

The turner, who is facing the cranks, twists the ends together anti-clockwise, at the same time keeping his full weight on the rope end which is being laid up. The layer advances, placing the strands side by side as they turn.

When the layer is experienced this can be done quickly.

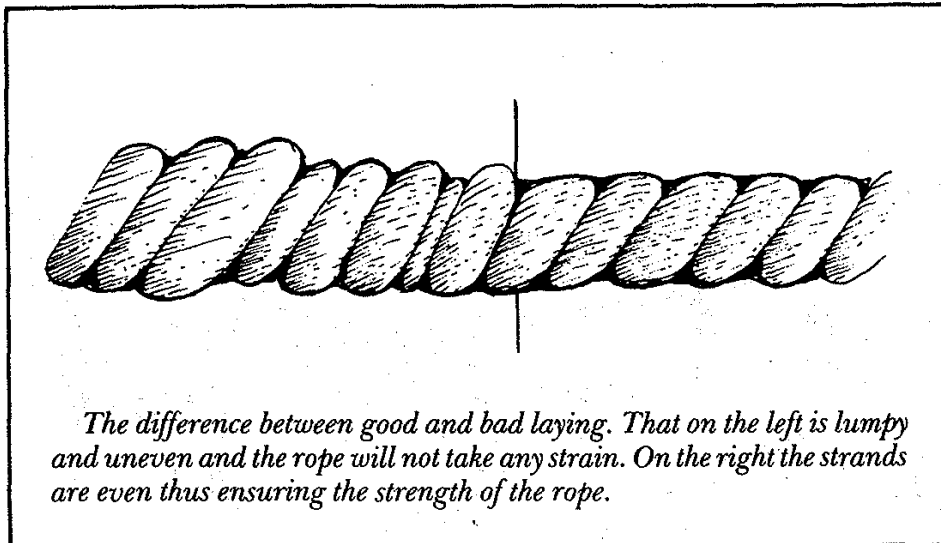

It is important to learn to feed the material evenly and lay up slowly thereby getting a smooth and even rope. Do not attempt to rush rope-making. If you do, all that will result is a mess of uneven badly spun strands and ugly lays, resulting in poor rope.

Speed in rope-making comes only with practice. At first it will take a team of three or four up to two hours or more to make a 25-metre length of rope of three lays, each of three strands — a total of nine strands for a rope with a finished diameter of about 25 cm. But with practice the same three or four people can make a similar rope in fifteen or twenty minutes. These times do not, of course, include the period spent in searching for material.

In feeding the free ends of the strands twist in the loose material pushed in by the feeder. The feeder must move backwards at a speed governed by the feeding rate. As he moves backwards he must keep a slight tension on the strands.

MAKING ROPE WITH A SINGLE SPINNER Two people can make rope using a single crank.

A portion of the material is fastened to the eye of the crank (as with the multiple crank handle) and the feeder, holding the free ends of this strand against the bundle of loose material under his arm, feeds in walking backwards. Supporting crossbars, as used in a ropewalk, are required when a length of more than 5 metres is being spun.

FEEDING If the feeder is holding material under his left arm, his right hand is engaged in continuously pulling material forward to his left hand from where it is fed into the turning strand. These actions, done simultaneously and continuously as the feeder walks backwards, govern the thickness of the strands. His left hand, lightly closed over the loosely turning material, must feel the fibres 'biting' or twisting together.

When the free end of the turning strand, which is against the loose material under his arm, takes in too thick a tuft of material he closes his left hand and so arrests the twist of the material between his left hand and his bundle. This allows him to tease out the overfull 'bite', with his right hand. In proceeding in this manner the feeder maintains a uniform thickness in the spinning strand.

There is a definite knack in feeding. Once a person has mastered it he can move backwards and feed with considerable speed.

THICKNESS OF THE STRANDS Equal thickness for each of the strands throughout their length and equal twist are important. The thickness should not be greater than is necessary for the material being used. For grass rope the strand should not be more than 5 mm in diameter, for coarse bark or palm not more than 3-4 mm, and for fine bark, hair or sisal fibre not more than 3 mm.

For fine cords the strand should be no more than 2 mm in diameter.

Fine cords cannot be made from grass unless the fibres are separated by beating out and combing.

The correct amount of twist is when the material is hard; that is, when the twist feels tight to the touch.

COMMON FAULTS There is a tendency for the beginner to feed unevenly. Thin, wispy sections of strand are followed by thick hunks. Such feeding is useless. Rope made in such a manner will break when less than a quarter of its breaking strain pressure is applied.

The beginner should twist and feed slowly and make regular and even strands, rather than rush the job.

Thick strands do not help. It is useless to attempt to spin up a rope from strands 25 mm or more thick. Such a rope will break with less than half the potential strain of the material. It may save time but the rope will be both weak and dangerous.

Plaiting

One person alone may need a considerable length of rope. But making such a length by one's self is an arduous and slow process.

However one may be lucky enough to have at hand a considerable amount of material that is reasonably long — say between 30 cm and 1 metre or more.

This material can be plaited or braided into a suitable rope length. The normal three plait makes a flat rope, which while quite good does not have the finish or shape of a true rope. Neither is it as tight as the lariat or four plait.

At other times it may be necessary to plait broad bands for bolts or for shoulder straps. There are many fancy plaits or braids and one can develop from these. But these three are basic and are essential for practical work.

A general rule for all plaits is to work from the outside into the centre.

In learning to plait or braid there is no need to 'go bush',

as it were, nor to even use bush materials. The skills can be acquired using standard ropes and twines or leather strips.

Once the skill is acquired with these more manageable and familiar materials then trials can be conducted with various bush products to see which plait or braid is most suited to what is at hand.

THREE PLAIT Take the right-hand strand and pass it over the strand to the left.

Take the left-hand strand and pass it over the strand to the right and repeat alternately from left to right.

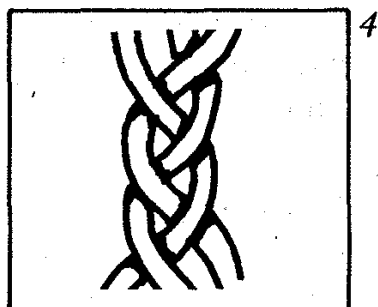
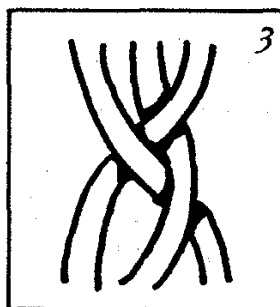
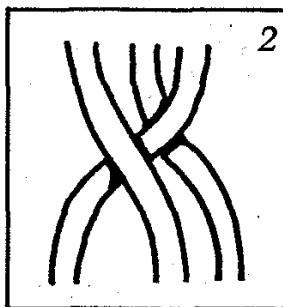
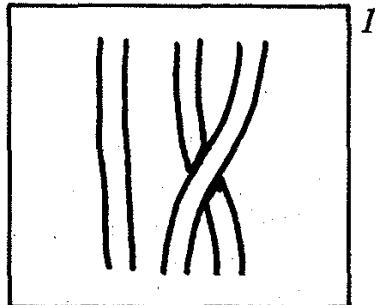

FLAT FOUR PLAIT Lay the four strands side by side. Take the right-hand strand as in Fig. 1 and lay it over the strand to the left.

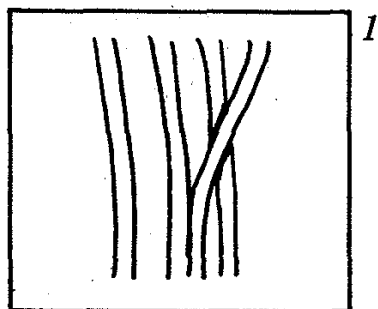

Now take the outside left-hand strand as in Fig. 2 and lay it under the next strand to itself and over what was the first strand.

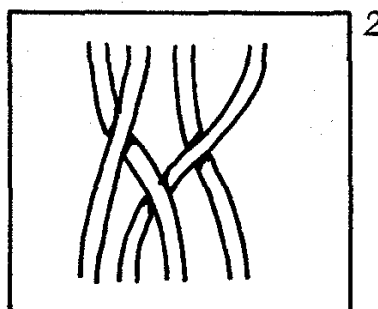

Take what is now the outside right-hand strand, and lay it over the first strand to its left.

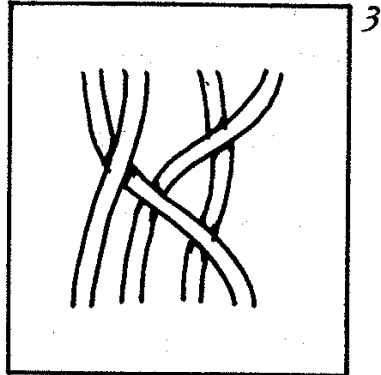

Take the outside left strand and put it under and over the next two strands respectively moving towards the right.

Thereafter your right-hand strand goes over one strand to the left, and your left-hand strand under and over to the right, as shown in Fig. 4.

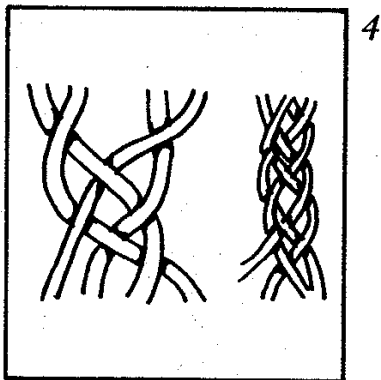

BROAD PLAIT To commence. Take six, seven or more strands, and hold them flat and together.

Take a strand in the centre and pass it over the next strand to the left, as in Fig. 1.

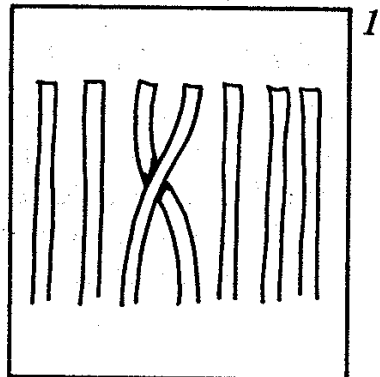

Take the second strand in the centre to the left and pass it towards the right over the strand you first took so that it points towards the right as in Fig. 2.

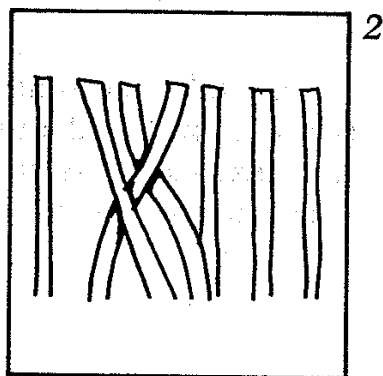

Now take the next strand to the first one and weave it under and over as in Fig. 3.

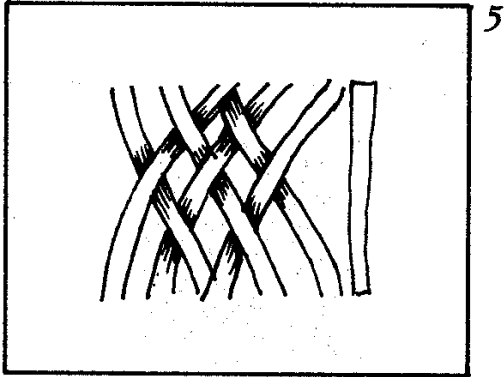
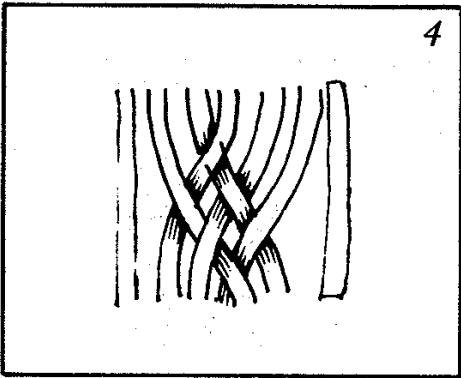
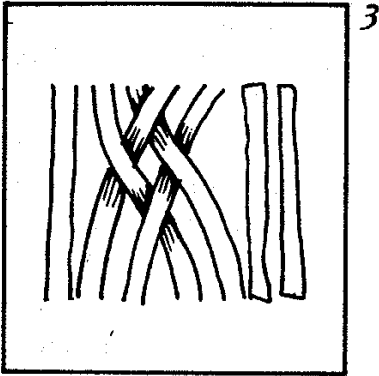

Weave the next strands from left and right alternately towards the centre as in Fig. 4,5,6.

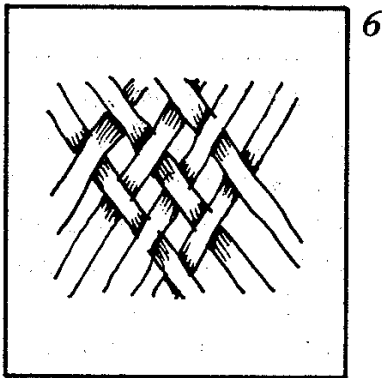

The finished plait should be tight and close as in Fig. 7.

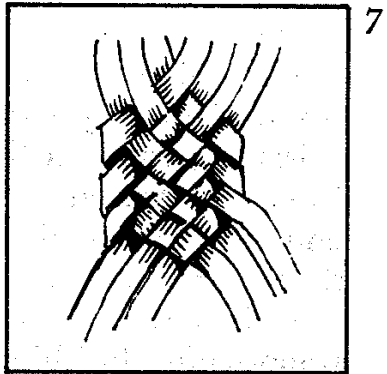

TO FINISH OFF Take one of the centre strands, and lay it back upon itself as in Fig. 1.

Now take the first strand which it enclosed in being folded back, and weave this back upon itself as in Fig. 2.

2. Take a strand from the opposite side, and lay it back and weave it between the strands already plaited.

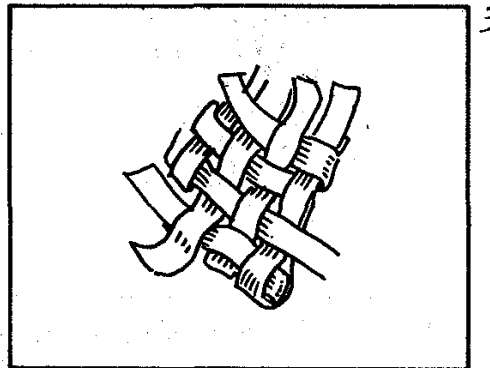
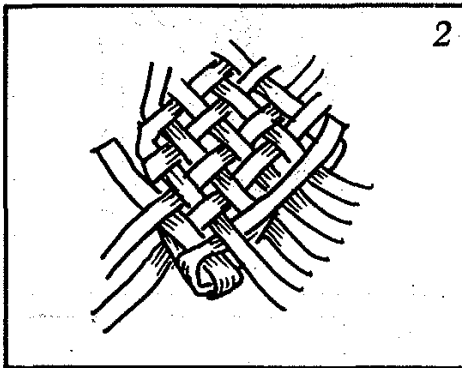
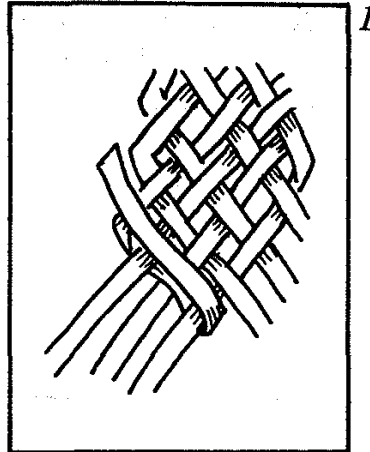

All the strands should be so woven back that no strands show an uneven pattern, and there should be a regular under-over-under of the alternating weaves.

If you have plaited tightly there may be a difficulty in working the loose ends between the plaited strands.

This can be done easily if you sharpen a thin piece of wood to a chisel edge, and use this to open the strands sufficiently to allow the ends being finished to pass between the woven strands.

Roll under a bottle to work smooth after finishing off.

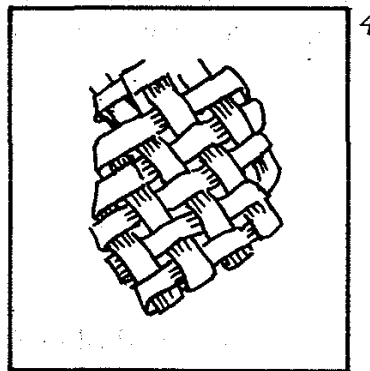

ROUND OR LARIAT PLAIT. FOUR STRANDS Lay the four strands together side by side, as in Fig. 1, and cross the right-hand centre strand over, and then around the left-hand strand.

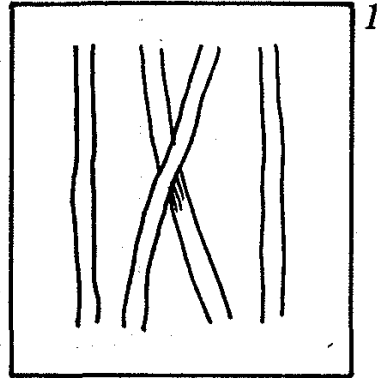

Take the left-hand outside strand, and pass it over the two crossed strands, and then under the right-hand one of the two, so that it is pointing towards the left, as in Fig. 2.

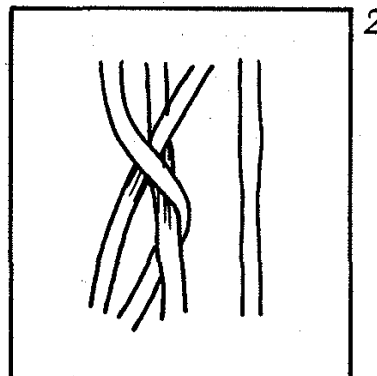

Take the free right-hand strand, and pass it over the two twisted strands to the left and completely round the left-hand one of the two, as in Fig. 3.

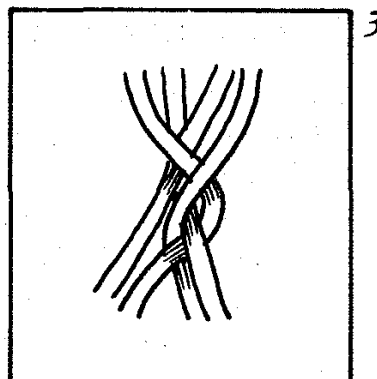

Repeat this with the outside left-hand strand as in Fig. 4.

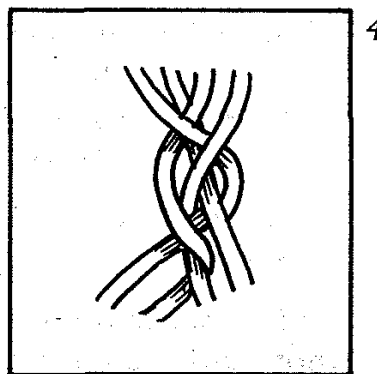

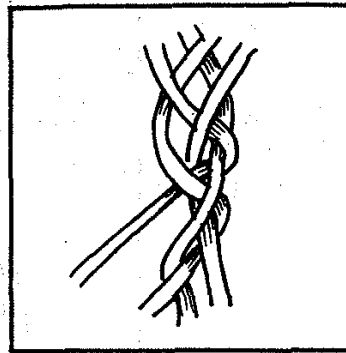

5

Repeat with the right-hand strand as in Fig. 5.

The finished plait should look like Fig. 6.

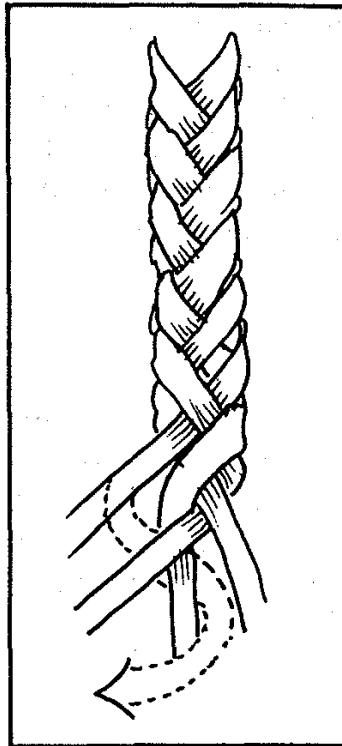

6

Tying split canes and vines together

These bush materials will only tie with special knots. As a safety rule tie with the outside of the skin on the outside bend of the knot. If you try to tie with the inside of the material on the outer surface of the bend it is probable that the material will either crack or snap off forcing you to come to the conclusion that the material is useless.

When pulling the knot taut, do so gently. If you snap the joining knot the material will either cut itself or break.

If the canes or vines are brittle through greenness, try the heat treatment mentioned previously.

The knots which are most suitable for tying canes and vines together are as follows.

Joining: sheet bend, reef knot, fisherman's knot

Securing: timber hitch

For descriptions on how to tie these knots see Chapter 2, Knots and Lashings.

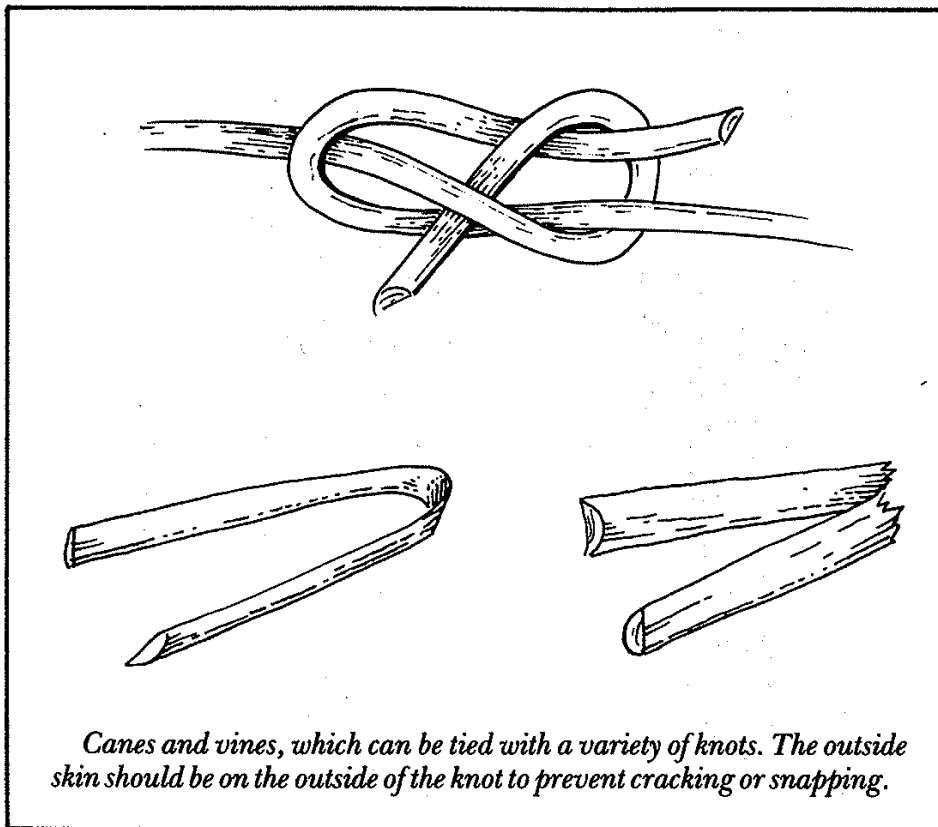

Using bush ropes for climbing

Before entrusting your life to a bush-made rope it should be tested.

The simplest way of doing this is to tie one end of your intended heavy-duty rope securely to a tree. Three or four people should then get hold of the other end of the rope. They should take the strain gently at first. They should slowly increase this strain until all their combined weight is on it. If it does not break then it is safe for one person at a time to use to ascend or descend a rock or cliff face.

When climbing up a bush-made rope always use the footlock and when descending never slide down it. Climb down, using the same footlock.

The footlock offers a measure of safety and the climber is so secure that he can actually stand on the rope and rest without his body weight being carried entirely on his arms.

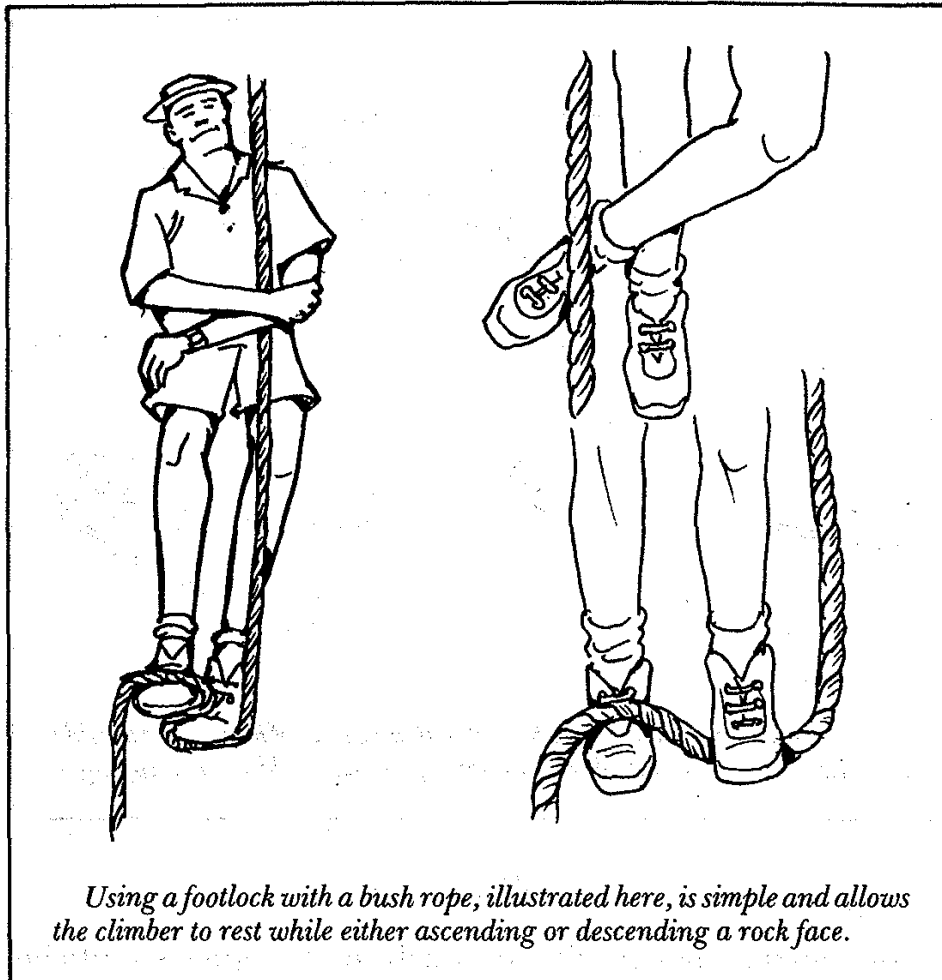

To prove this use the footlock and clasp the rope to your body with your arms.

The footlock is made by holding onto the rope with both hands, lifting the knees and kicking the rope to the outside of one foot. The foot on the opposite side to the rope is 'pointed' so that the toe picks up the rope which is pulled over the foot which was against the rope and under the instep of the foot which 'picked' it up.

The two feet are brought together and the rope is now over the instep of one foot and under the ball of the other. Then, to secure the grip and lock the rope, the feet are placed one on top of the other so that it is clamped down by the foot on top.

By straightening the knees and raising the hands the body is lifted and a fresh grip taken for the next rise.

In descending, the body is bent, the hands lowered and the footlock released. A fresh grip is then taken with the feet at a lower level on the rope.

This method of descending is much safer than sliding. In sliding there is grave risk of bad rope burns to both hands and legs.

Another method of descending a rock face is by using the abseil. In some cases it also can be used for ascent.

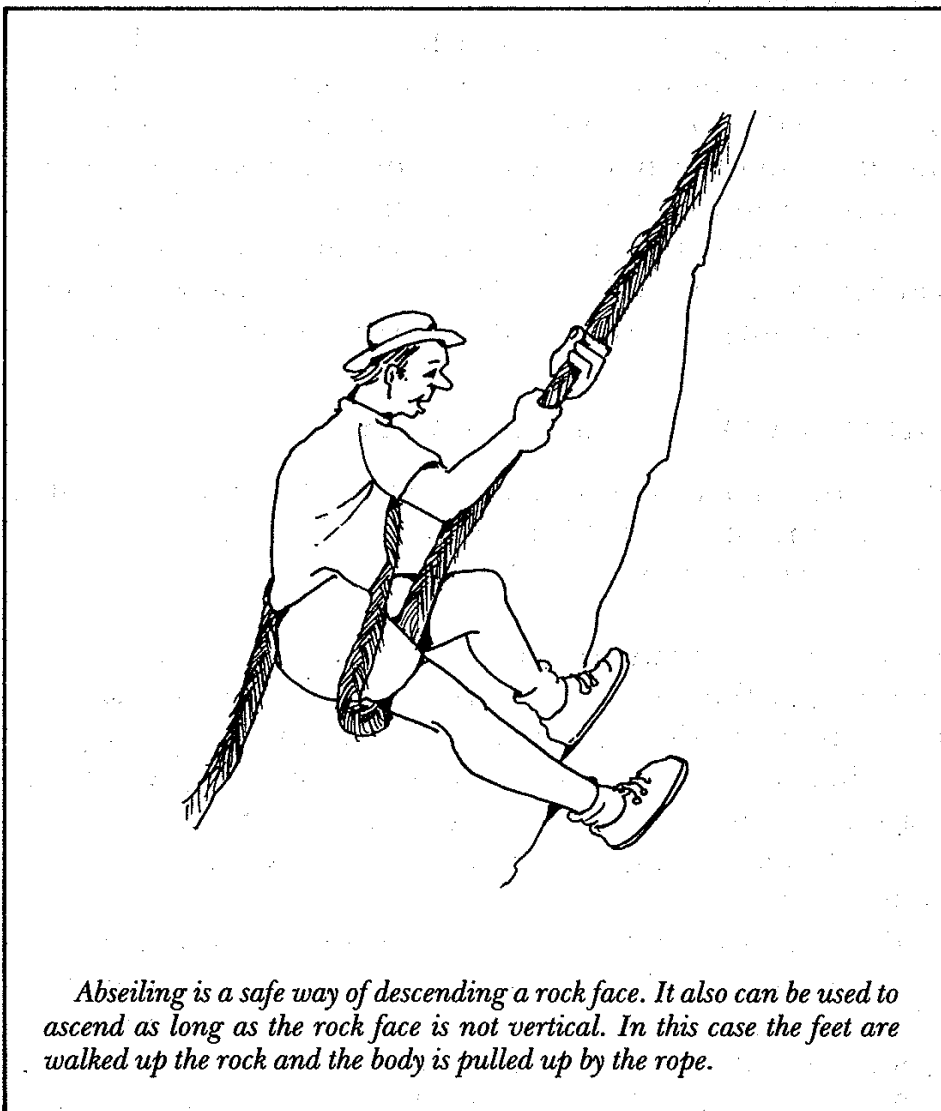

Abseiling is a safe way of descending a rock face. It also can be used to ascend as long as the rock face is not vertical. In this case the feet are walked up the rock and the body is pulled up by the rope.

In the abseil the body is upright but the legs are stretched out and the feet pressed against the rock face.

The rope passes down between the thighs, around one thigh and diagonally up and across the upper half of the body and over the shoulder opposite to the leg under which it passes. The rope may be gripped with one hand.

In descending the free hand pulls the rope over the shoulder. This leaves a loop below the thigh and the feet are 'walking' down the rock face until the thigh is again snug in the loop. Using the abseil for descending makes it practically impossible to fall.

In ascending a rock face which has an extreme slope but is not vertical the feet are 'walked' up the incline, the body is pulled up the rope and the slack, hanging below the legs, is pulled up in its turn by one hand and fed over the shoulder. By this means the climber can sit on the rope and rest.

When using the abseil it will be found that bare feet, sandshoes or ones with ripple rubber soles made especially for such a purpose give a better grip than plain leather soles.

Other uses for bush-made ropes

Bush ropes have many other uses other than for descending or climbing rock and cliff faces. The following are but a few examples of uses to which they can be put.

SINGLE ROPE LADDER WITH STICKS A single rope ladder is made by opening the lays of the rope and inserting sturdy cross sticks about 20-25 cm long with an equal amount protruding on either side. They must be secured to the rope by lashings both above and below. The distance between these ladder holds should be between 30 and 50 cm, depending on the agility of the climber.

To climb such a ladder hold the rope with both hands, bend the knees and draw both feet up together and lay them with even pressure on the cross sticks. When your footing is secure raise the hands and continue the action.

Bush single rope ladders have the advantage of being able

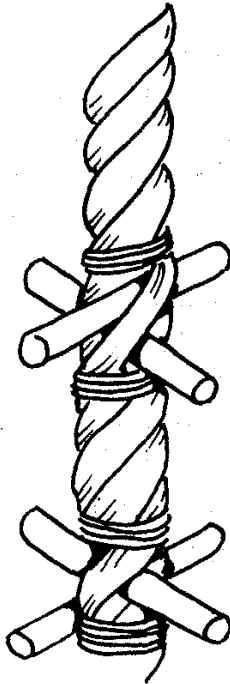

Bush ropes can be made into simple ladders by inserting two cross sticks at suitable intervals through openings made in the lays. They must be secured to the rope and lashed into place top and bottom to allow them to bear the climber's weight.

to be used by people who have difficulty in climbing by ordinary means. They provide a relatively easy way of ascending a rock face or a lookout.

SINGLE ROPE LADDER WITH CHOCKS This type of ladder has the advantage of being portable and quickly made. The chocks of hardwood should be about 15 cm in diameter and 5 cm deep. They are suitably bored to take the diameter of the rope. Splice an eye at the top end and seize in a thimble to lash the rope head securely. To secure the chocks put two strands of seizing between the strands of the rope and then work a wall knot.

ROPE BRIDGE A rope bridge is no easy undertaking. It should be made only if there is no other possible way of cross-

sing a river or a ravine and secondly, only if the crossing is intended to be a semi-permanent one.

At the outset two ropes are spun. They must be very strong and thoroughly tested. They are anchored to either side of the river either to convenient trees or stakes.

When the ropes have been stretched taut, light 'A' frames are made. The number required depends on the length of the bridge decking.

The first A frame is hooked onto the rope and pushed forward with a long pole. The footing, a straight sapling, is dropped down onto the crotch of the frame. The bridge builder walks out along this and hooks on the next A frame, pushes it out to the required distance and repeats the process until the far bank is reached.

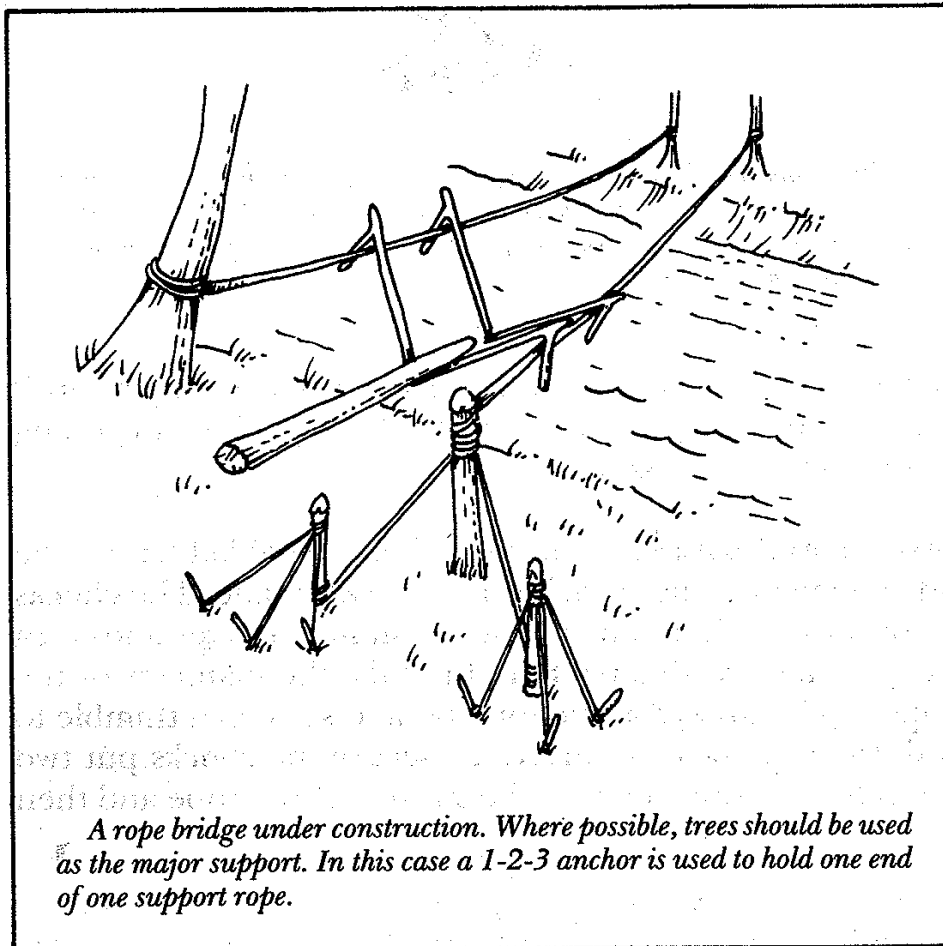

A rope bridge under construction. Where possible, trees should be used as the major support. In this case a 1-2-3 anchor is used to hold one end of one support rope.

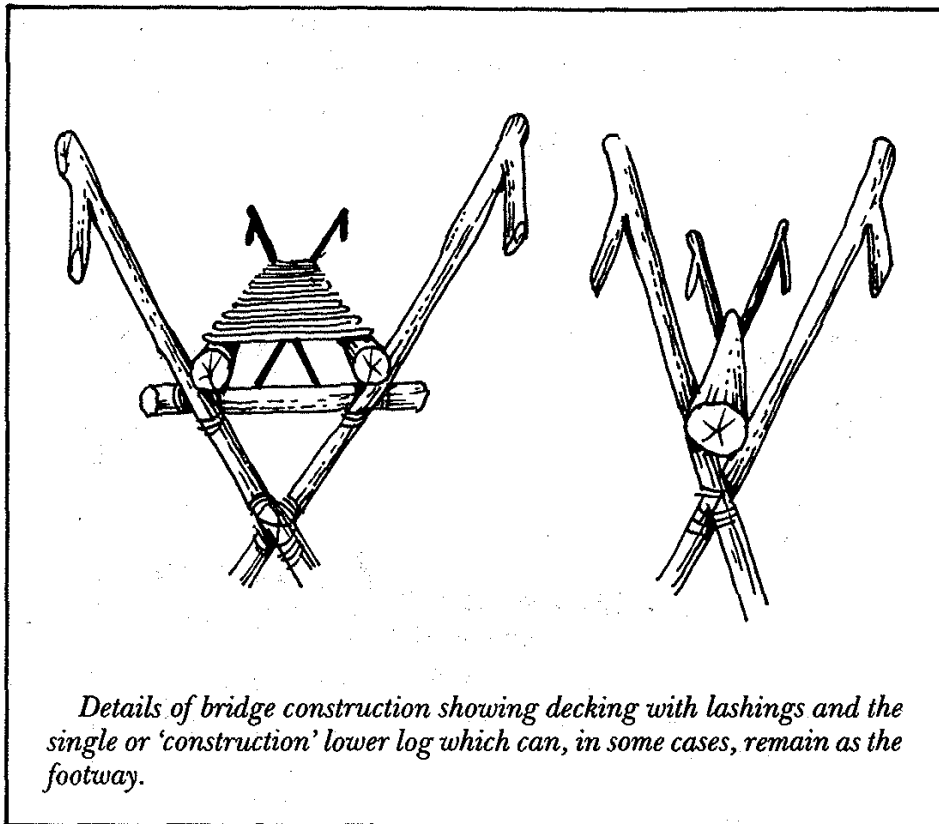

During building, rope bridges must not be overloaded — one worker at a time is the rule.

Once the base poles have been extended to the far bank crossbars should be lashed to the A frames above the base 'building' pole. Short lengths of flat split timber are then lashed to these poles to provide a secure decking.

If lianas or *Calamus* (lawyer vines) are available, make the support ropes from these. They are much stronger than any spun rope and can support four to six people on the bridge at a time.

To provide extra stability and to stop violent swaying when people are crossing with heavy loads, the rope bridge can be 'anchored' by attaching a heavy stone to a cord and suspending it from the middle of the bridge span. This anchor should be well above the known heavy rain flooding level of the river crossing otherwise it will be dragged by the current and tear the bridge in half.

In some cases the original building support pole can be used as the permanent bridge footwalk without further top slat decking. But in this case make sure that the bottom A frame lashings are extremely strong and secure.

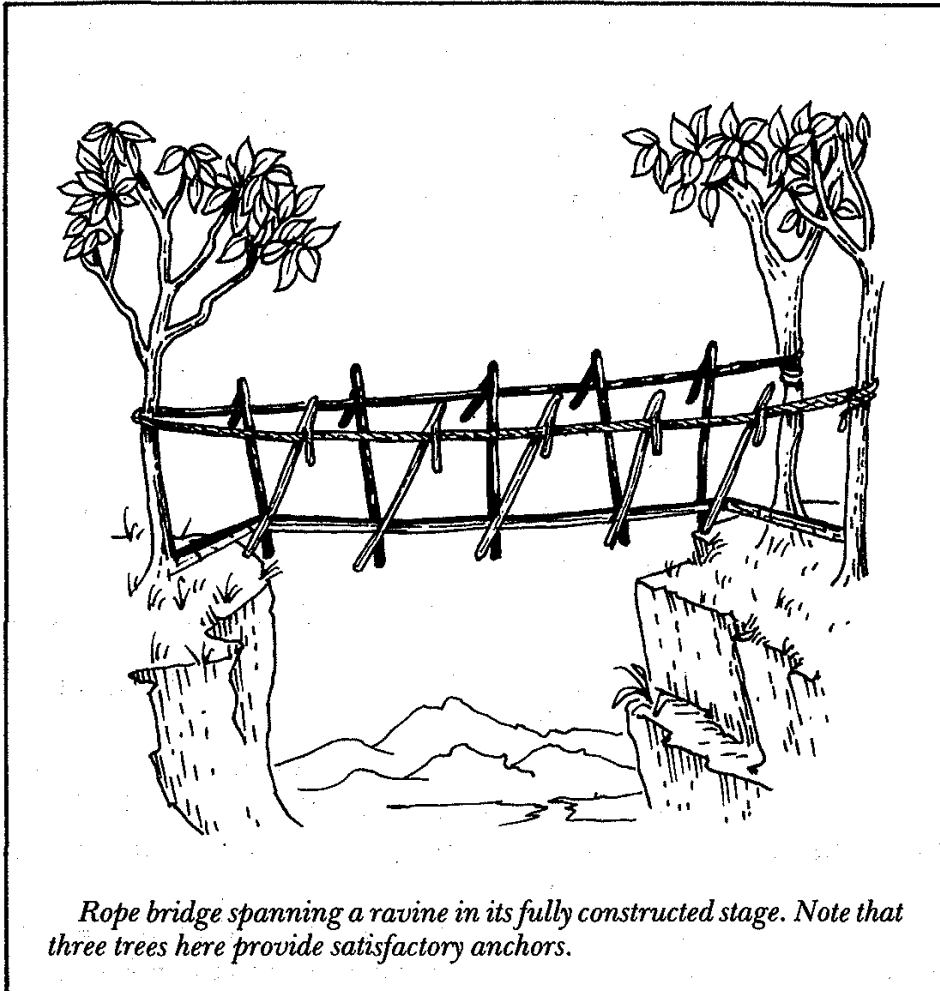

TO MEASURE THE DISTANCE ACROSS A RIVER OR GORGE Select a site on the opposite bank A and then drive a stake on the near bank B. Walk at right angles for a known number of paces and then put another marker stake C and continue an equal number of paces and put in a third marker D.

Turn at right angles away from the river and keep moving back until the centre marker stake and the mark on the other side are in line at E.

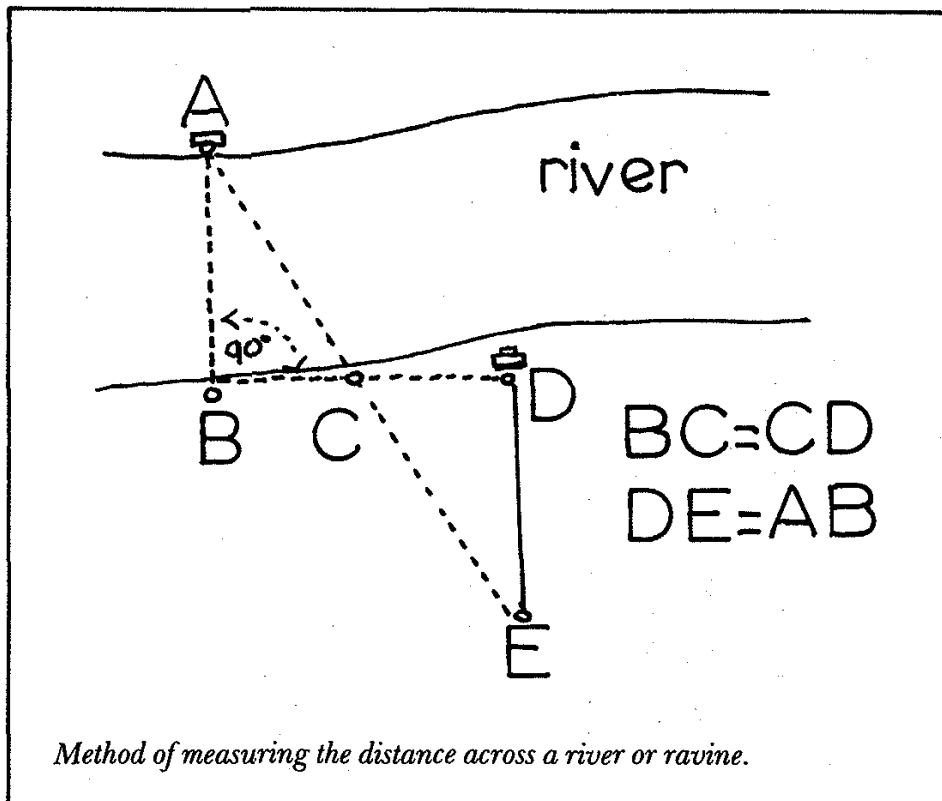

Measure the distance from the third or last marker peg D to this point E and this distance will equal that of the width of the river crossing.

TO GET A ROPE ACROSS A DEEP NARROW RIVER Fasten a stout stick to the end of the rope. The rope must be in the middle of the stick. Select a forked tree on the opposite bank, throw the free end of the coiled line with the stick across the river to the tree. When it has caught on the tree test it with two or three people to make sure the line is secure.

Fasten your (or the near) end of the rope to a convenient anchor.

Then the person crossing the line — usually the lightest member of the party — hangs onto it, lifts his legs and hooks them over the rope with his feet towards the opposite bank.

By this means he can work himself across the river, fasten the rope absolutely securely and allow the rest of the party to cross in a similar manner.

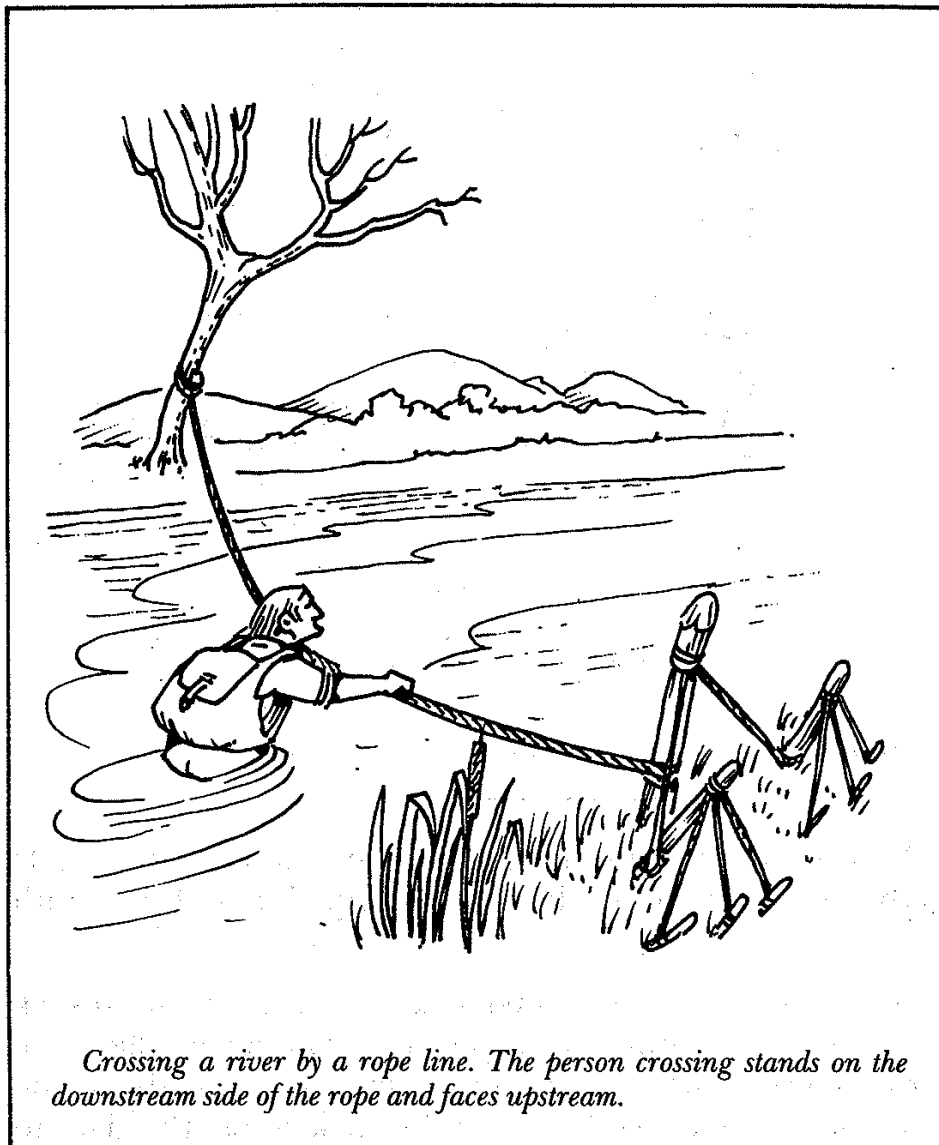

SAFETY LINE FOR A RIVER CROSSING A bush rope can be spun to serve as a safety line for crossing fast or flooded rivers. Once made, the hardest part is getting the first member of the party across with the rope.

The method is similar to that used with the beltman in surf lifesaving. One end of the rope is firmly anchored to the bank and the other tied around the waist of the strongest swimmer in the party. If possible he or she should be provided with something to aid buoyancy, such as a partially

inflated air mattress or air pillow. As the person enters the water the other members of the party should take hold of the line and pay it out slowly. He or she will undoubtedly be washed downstream to some degree and the rope should be made long enough to allow for this. On no account should this be attempted if the river is running full flood and is full of large floating masses of debris.

Once on the other side, the line should be anchored so it hangs above water level. The first person crossing the line should stand on the downstream side of the rope and face upstream. He then crosses by moving his feet sideways one step at a time, holding on to the rope at all times to maintain balance.

If the current is so strong that the person crossing loses footing, the grip on the line will prevent him or her from being washed downstream. If necessary any pack or other baggage should be abandoned. The bank can be made in safety by holding onto the line and working hand over hand until a secure footing is again possible.

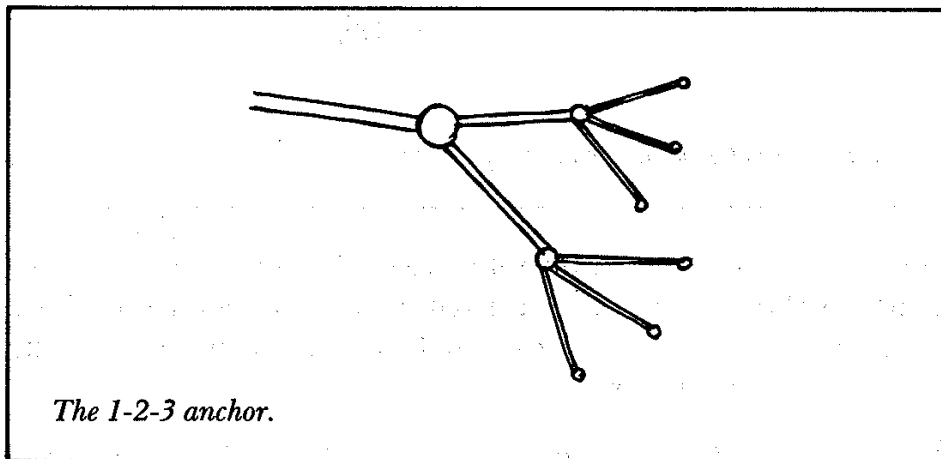

THE 1-2-3 ANCHOR This anchor is used when there are no supporting trees or tree stumps available to securely anchor a rope.

A very stout stake is driven into the ground at an angle of 45°. The main rope to be anchored is fastened to the foot of this. Two ropes are secured to the head of this stake and

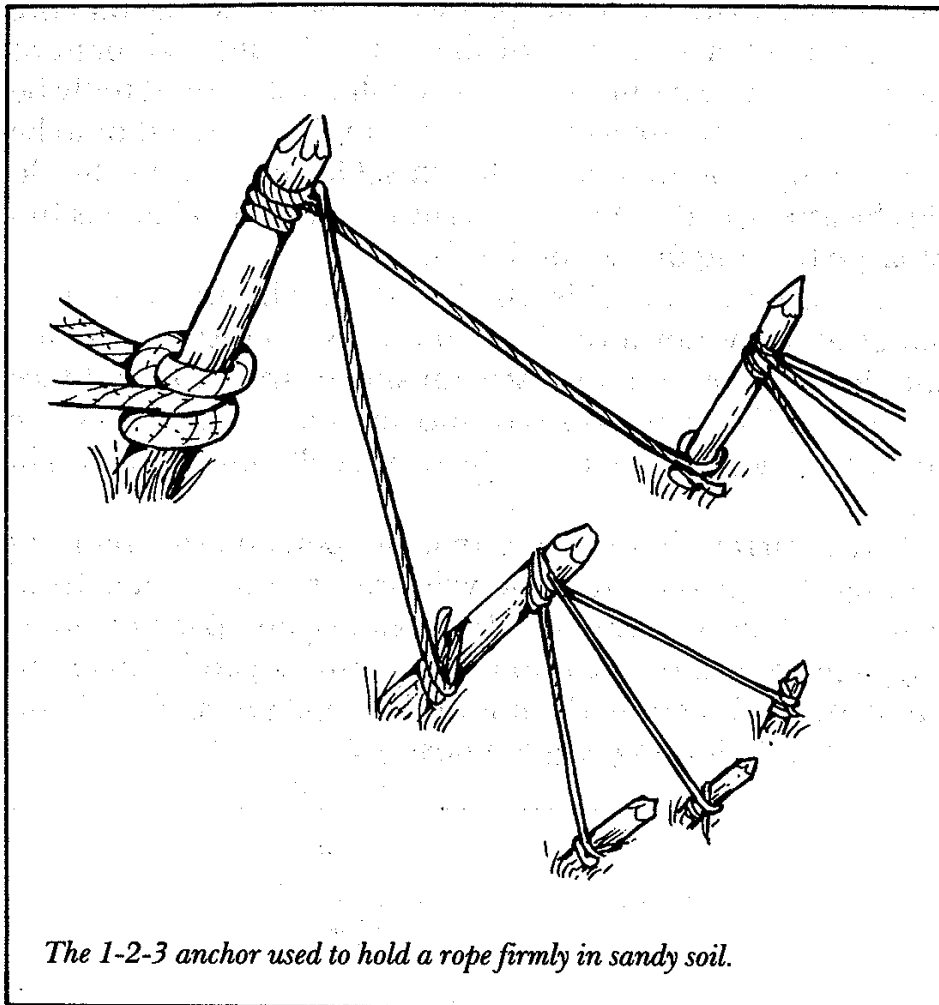

these are fastened to the foot of two stakes to the rear. The heads of these stakes are, in turn, fastened back to the foot of three other stakes. This anchor will hold securely in almost any conditions.

ANCHORING A PEG IN SAND OR SNOW The only way to anchor a rope into soft sand or snow is to attach it to a peg and bury the peg.

Scrape a trench in the sand (or snow) to a depth of between 30 and 50 cm. It can be deeper if windy or stormy weather is expected. Pass the rope around the centre of the peg and scratch a channel for it at right angles to the peg trench.

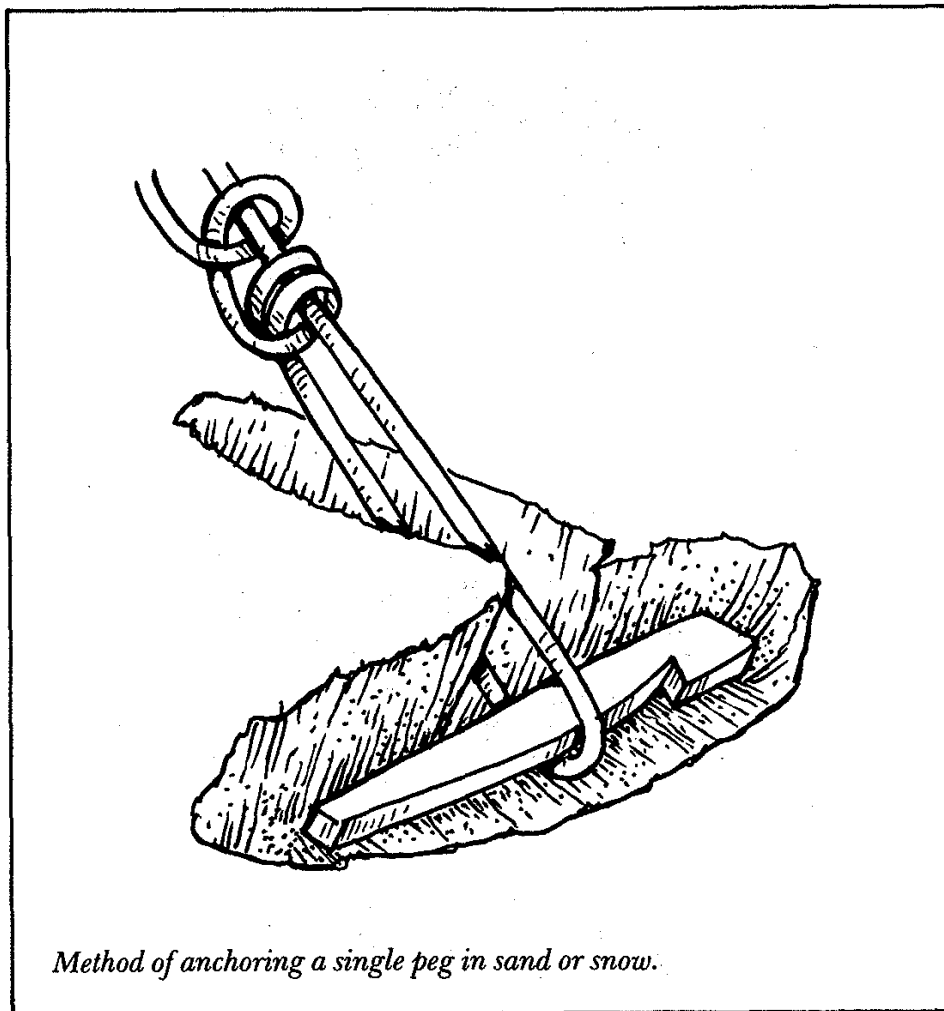

Fill in the trench and rope channel and fasten the free end of the rope to the standing end with a stopper hitch (see Chapter 2 Knots and Lashings) and pull taut. The buried peg should hold a tent rope in sand or snow under all normal conditions.

THE BUSH WINDLASS A bush windlass, capable of taking a very heavy strain on a rope, can be made by selecting a site where a tree has its fork low to the ground, with the fork facing the direction in which the pull is required. Alternatively a stout fork can be driven in and anchored with the 1-2-3 method.

The windlass portion is a forked log. The forks are

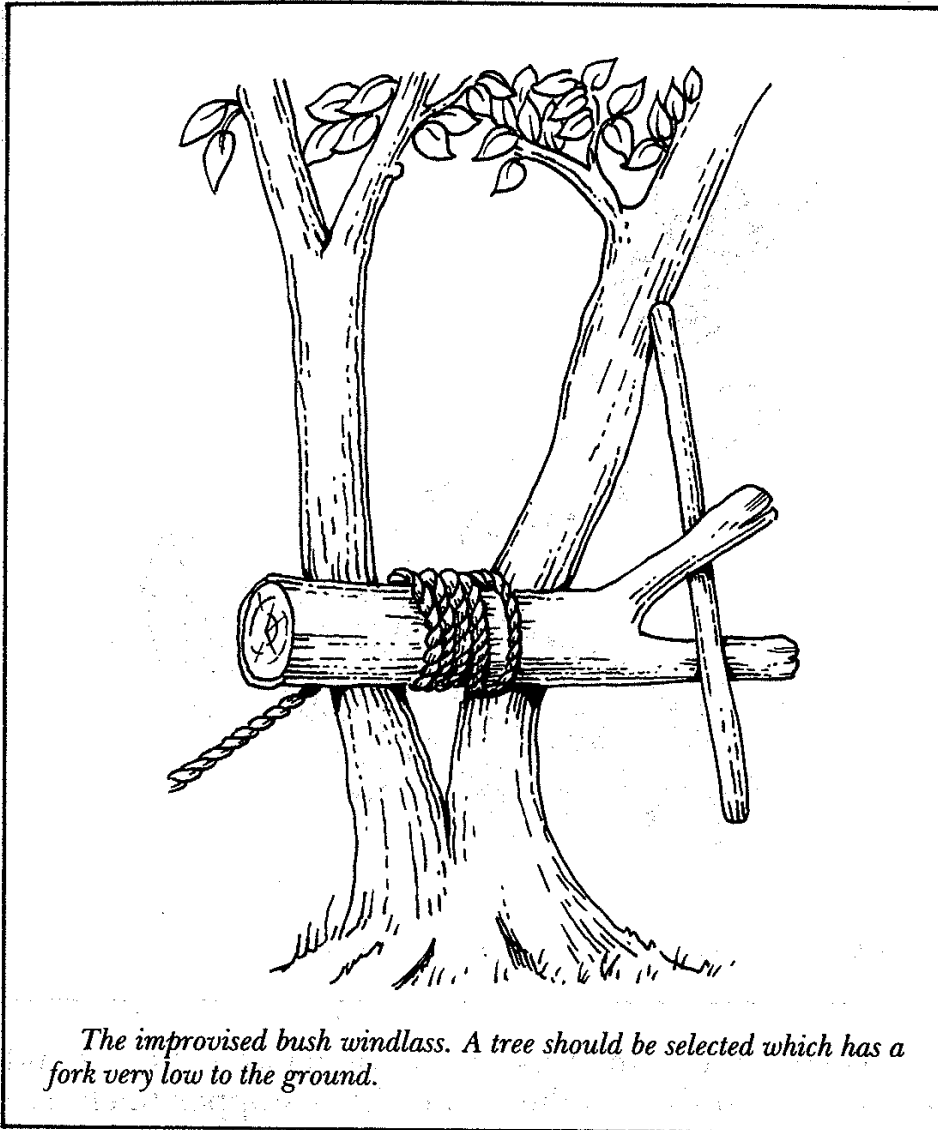

The improvised bush windlass. A tree should be selected which has a fork very low to the ground.

notched to take the lever (up to 1 metre long). The rope is passed around the roller a few times so that it locks upon itself. Alternatively if the fork of the roller is long and rather narrow the rope may pass through the fork.

This type of bush windlass has many uses.

2 Knots and Lashings

The ability to join two pieces of natural material together and so increase their length gives man the ability to make quite complicated constructions in the bush, or indeed anywhere.

Sailors were always the leaders in the tying of knots because for them it was necessary to tie securely but also to be able to untie rapidly, often in the dark and in appalling weather with rain-tightened ropes.

In bushcraft work probably half a dozen knots would suffice. But once started, knot tying can become fascinating for itself.

Knots and lashings take the place of nails for much bushwork. A brief description is given in this chapter of the uses of the various knots.

Note that the letter F means the free or untied end of the rope and the letter S the standing or secured end.

Knots for rope ends or for grips on thin rope

THUMB KNOT This knot is used to make a stop on a rope end, to prevent the end from fraying or to stop the rope slipping through a sheave.

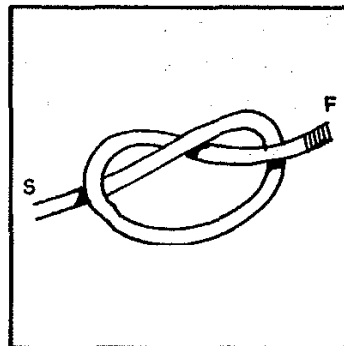

OVERHAND KNOT Overhand knot may be put to the same use as the thumb knot. It makes a better grip knot, and is easy to undo.

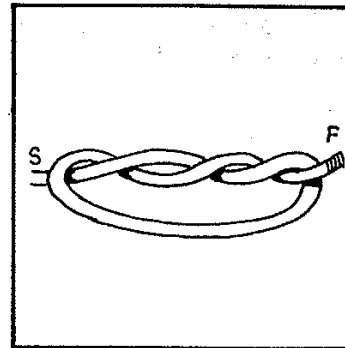
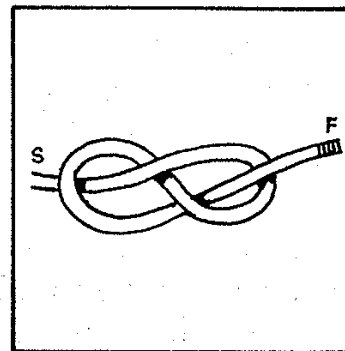
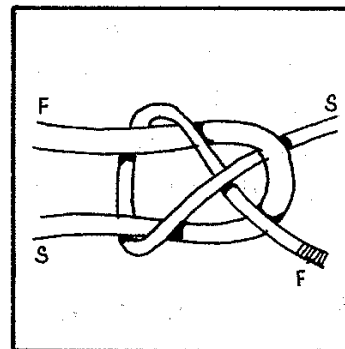

FIGURE EIGHT This knot is used as the thumb knot. It's easy to undo, and more ornamental.



Knots for joining ropes

SHEET BEND This is used to join or bend two ropes of unequal thickness together. The thicker rope is the bend.



DOUBLE SHEET BEND This is similar to single sheet bend, but gives greater security; it is also useful for joining wet ropes.

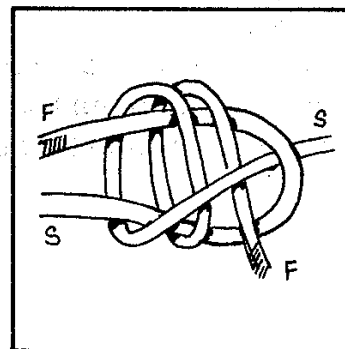

CROSSOVER SHEET BEND This holds more securely than either the single or double sheet bend and has occasional real uses such as fastening the eye of a flag to its halyard where the flapping might undo the double sheet bend.

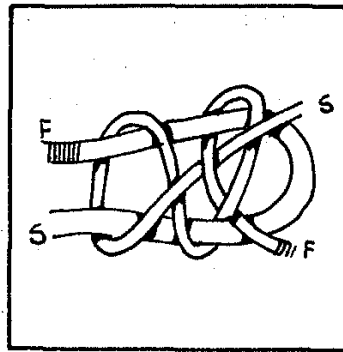

REEF KNOT To securely join two ropes of equal thickness together. Notice the difference in position of the free and standing ends between this and the thief knot.

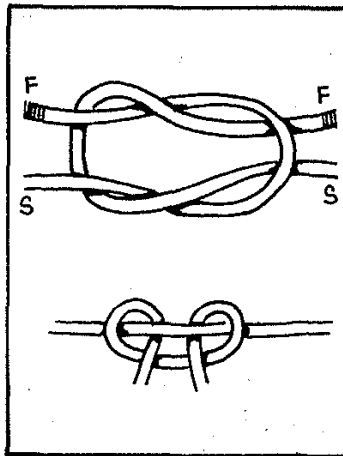

THIEF KNOT This is used to tie two ropes of equal thickness together so that they will appear to be tied with a reef knot, and will be retied with a true reef knot. This knot was often used by sailors to tie their sea chests, hence the name.

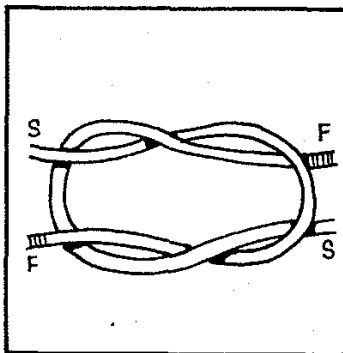

CARRICK BEND This bend is for the secure fastening of two ropes of even thickness together. It is particularly suitable for hawsers and steel cables. It can be readily undone and does not jam, as do many other bends and knots.

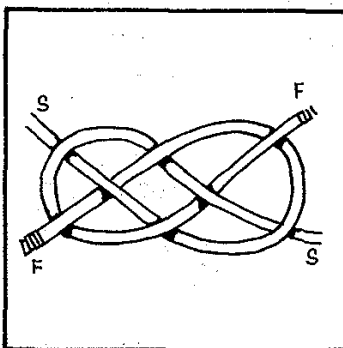

STOPPER HITCH This is used to fasten a rope to another rope (or to a spar) on which there is already strain. When the hitch is pulled tight the attached rope will not slip, and the tension on the main rope can be taken on the attached rope. Also useful for a climbing hitch.

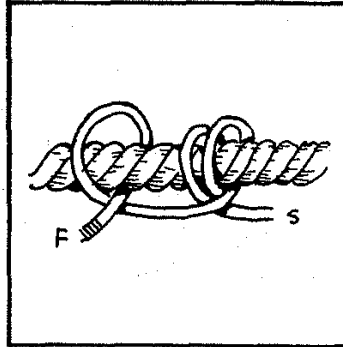

FLEMISH KNOT OR DOUBLE OVERHAND KNOT Used for securing two ropes or cords of equal thickness together.

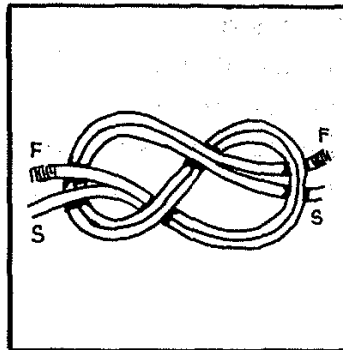

FISHERMAN'S KNOT Used for joining two springy materials together; suitable for wire, fishing gut or vines. Two thumb knots (one on each rope) pulled tight. The knots lock together.

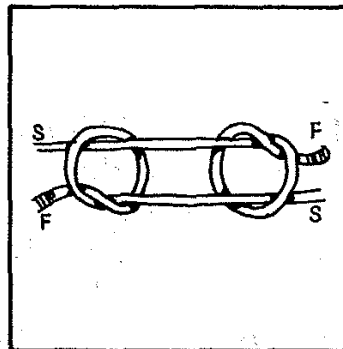

OVERHAND FISHERMAN'S KNOT Similar to fisherman's knot; for general uses. More positive for gut fishing lines and nylon.

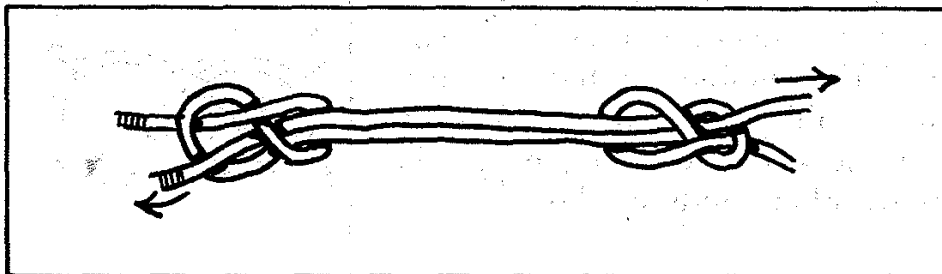

Knots to make loops in rope

BOWLINE This is used to form a loop that will not slip on a rope end.

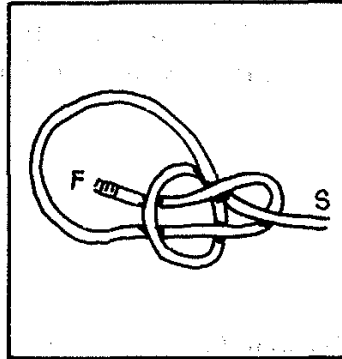

BOWLINE ON A BIGHT Used to make a double loop that will not slip on a rope end. Also called a bo'sun's chair.

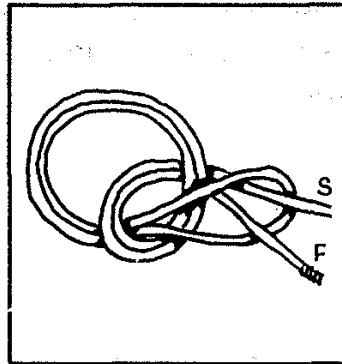

FISHERMAN'S EYE KNOT This is the best method of making a loop or eye in a fishing line. The strain is divided equally between the two knots.

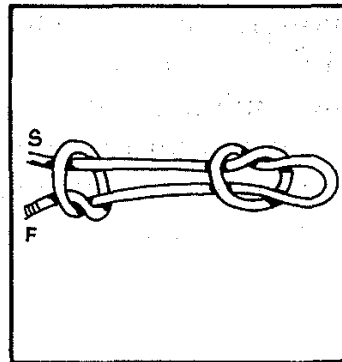

SLIP KNOT Used for fastening a line to a pier or a pole or any other purpose where strain alone on the standing end is sufficient to hold the knot.

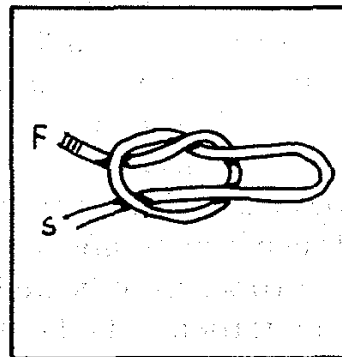

OVERHAND EYE KNOT This method of making an eye or loop is satisfactory and quick, but it sometimes jams and becomes difficult to untie.

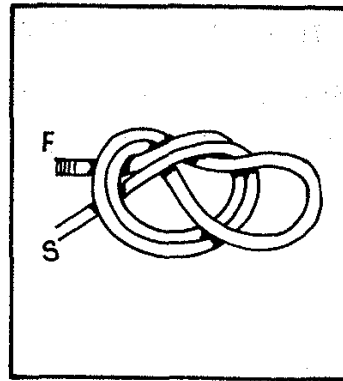

FLEMISH EYE KNOT Used for all purposes where a loop is required, less likely to jam than overhand eye knot.

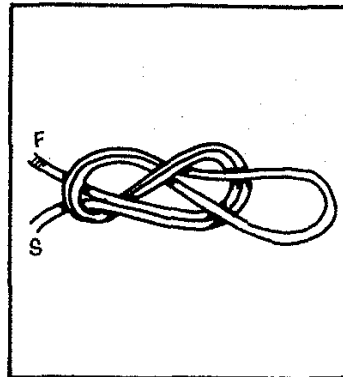

CRABBINS HITCH This eye knot, though not very well known, is one of the stoutest eye knots. It has not the tendency to cut itself out or pull out common to some of the other eye knots. It also makes a useful running knot.

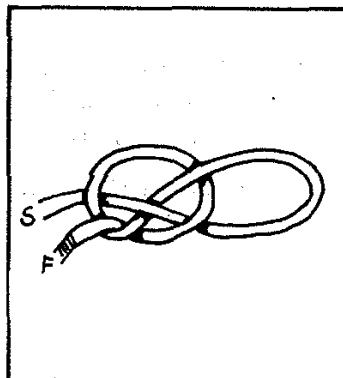

MANHARNESS KNOT This is a most useful knot for making a series of non-slip loops in a rope for the purpose of harnessing men for a pull. The marlinspike hitch is made as in lower sketch and then the loop is drawn under and over the other two ropes as indicated. The whole knot is then pulled taut.

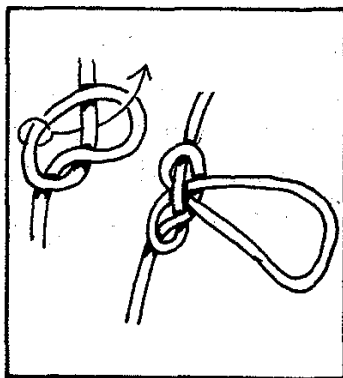

MIDSHIPMAN'S HITCH This is an old-fashioned hitch often used to fasten a block or sheave to a rope's end.

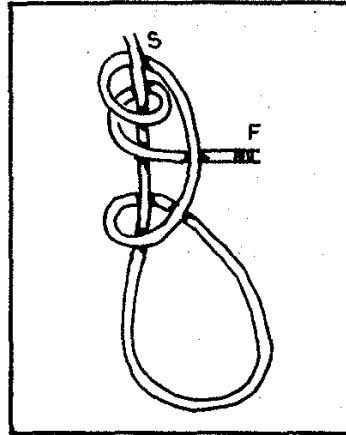

JURY KNOT OR TRUE LOVER'S KNOT
 This knot is primarily for a mast head, to form loops by means of which the mast may be stayed. It is called a jury knot because in sailing ship days it was often used to rig a temporary or jury mast. Three hitches as in top sketch are formed. The loop C is pulled under B and over A. D is pulled over E and under F. G is pulled straight up for the third loop. H is made by splicing the two free ends together.

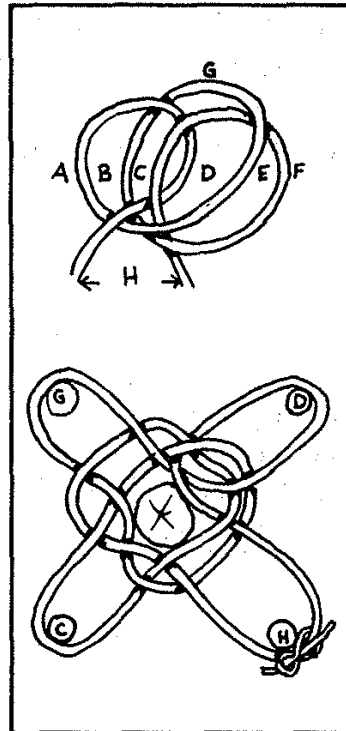

BOW THONG HITCH Used by New Guinea natives for securing the end of the split cane bow thong to the pointed end of the bow. Also useful for fastening rope over the tapered end of a spar.

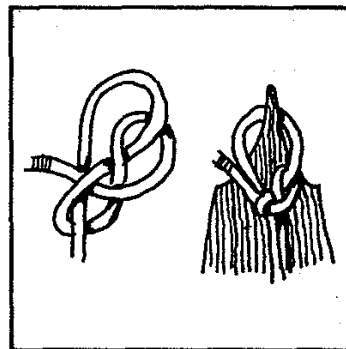

Knots for Fastening Ropes

SLIPPERY HITCH Very useful because of the ease with which it can be released in emergency. It holds securely so long as there is a strain on the standing end.

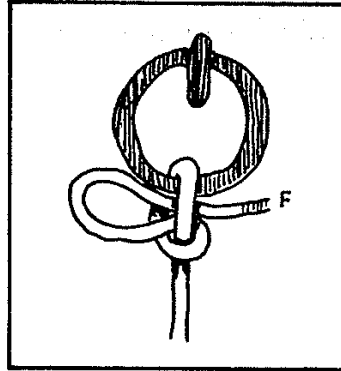

CLOVE HITCH For securing a rope to a spar. This hitch, if pulled taut, will not slip up or down on a smooth surface. A useful start for lashings.

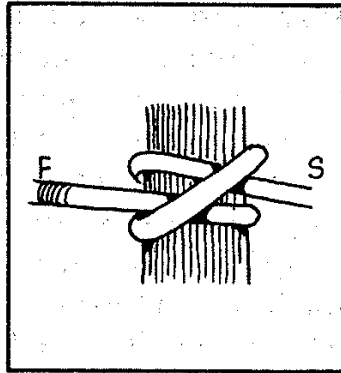

BOAT KNOT This is a method of securing a rope to a pin or other small piece of wood on a boat. It is quickly released.

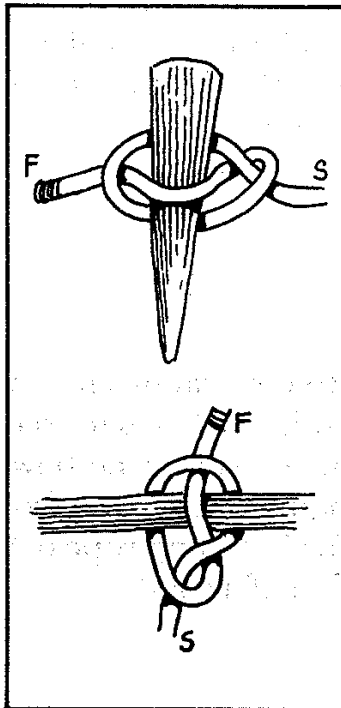

DOUBLE BOAT KNOT A bight is simply passed through the ring and a marlin spike or other round piece of wood is put between the bight or the rope. Withdrawal of the spike quickly releases the knot.

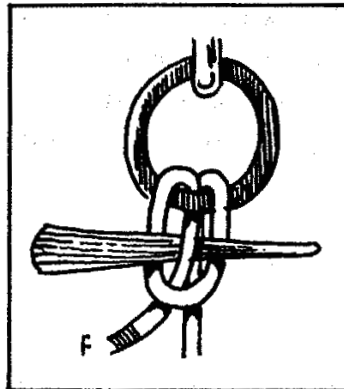

ROLLING HITCH To fasten a rope to a spar. This is a very secure fastening.

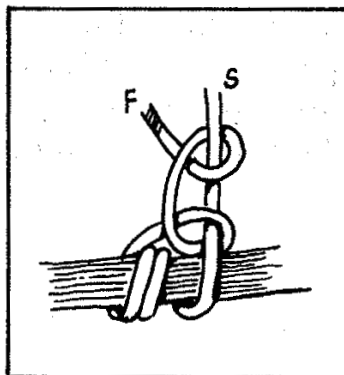

TIMBER HITCH For securing a rope to squared timber, round logs, etc. A good starting knot for all lashings. The standing end must pull straight through the loop, not backwards, or the rope may cut upon itself.

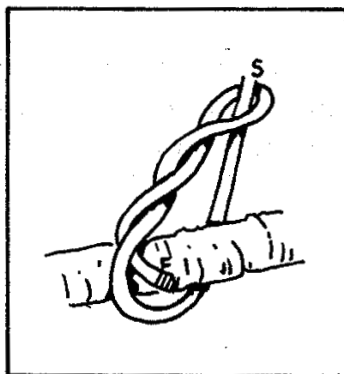

HALLIARD HITCH For fastening a rope to a spar. The sketch shows the hitch open. When pulled taut, and the hitches closed, it makes a very neat and secure fastening.

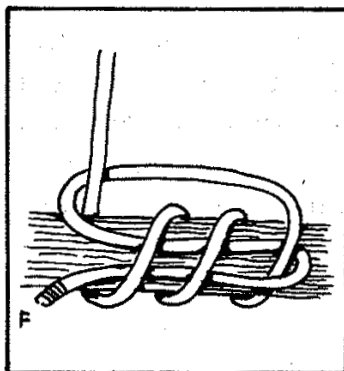

BLACKWALL HITCH A quick way to secure a rope to a hook. The strain on the standing end will hold the rope secure to the hook.

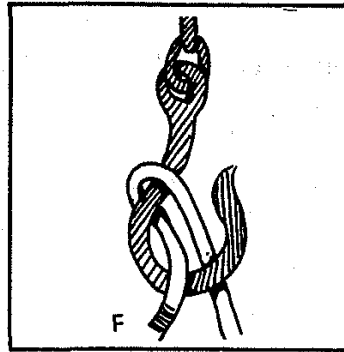

NOOSE HITCH This is a quick and easy method of securing a rope to a spar or beam. If desired, the rope can be made more secure by means of the over-hand knot shown in Fig. 2.

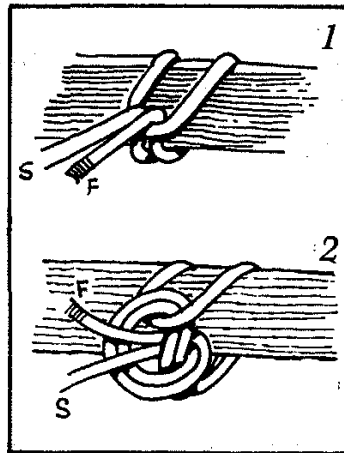

CAT'S PAW HITCH For securing a rope to a hook or a spar. It is most useful because it is so easily tied.

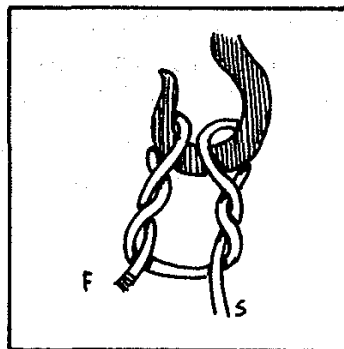

LARK'S HEAD This is an easy method of securing a rope to a ring or hook. If desired to make more secure, it can be stoppered, as shown, with an overhand or thumb knot.

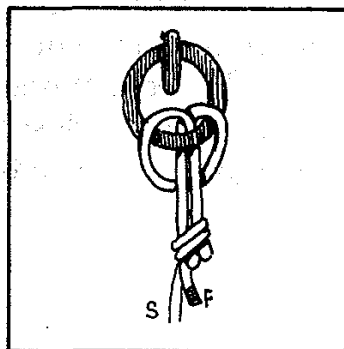

CROSSOVER LARK'S HEAD Used for same purpose as the Lark's head.

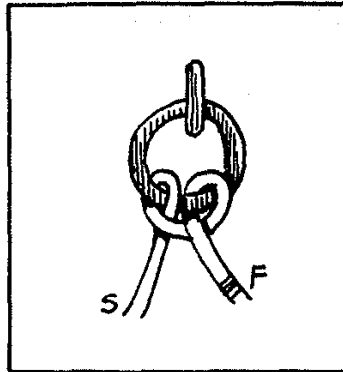

DOUBLE LARK'S HEAD The bight is first made. The ends passed through it. This knot is very secure.

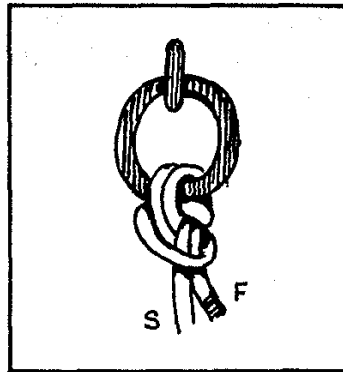

TRIPLE LARK'S HEAD The apparently complicated knot is easily made by taking the bight of the rope through the ring, the ends are passed through the bight and up through the ring, then down through its own bight. Like the double lark's head, this knot is absolutely secure.

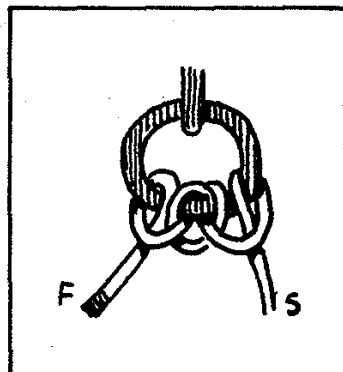

SAILOR'S BACKHAND KNOT Used to secure a rope to a ring or hook. This is very similar to the rolling hitch and sailor's backhand knot.

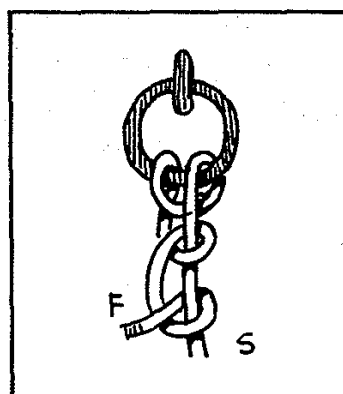

SAILOR'S BACKHAND KNOT (Alternative variation) Used to fasten a rope securely to a spar.

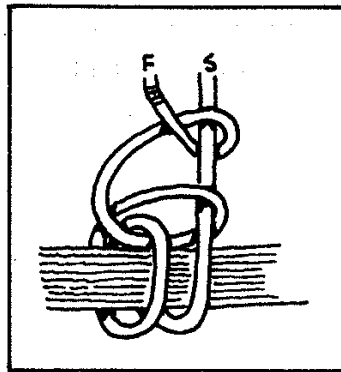

SAILOR'S KNOT Simply two half hitches round the standing end of the rope.

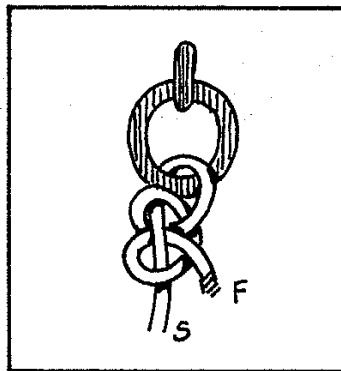

GUNNER'S KNOT This is simply a carrick bend and used to hold two shackles or rings together.

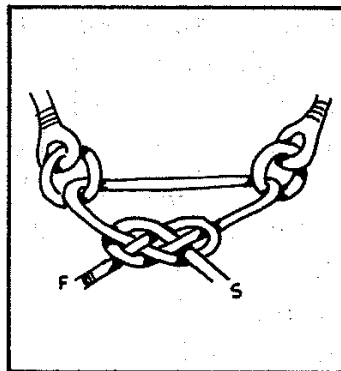

CATSPAW This knot is used for attaching a rope to a hook. The two bights are rolled two or three times and then put over the hook.

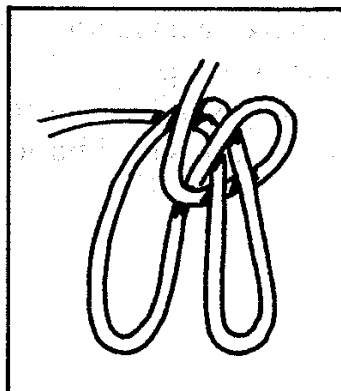

KELICK HITCH Used for fastening a stone (for a kellick in lieu of an anchor), that will hold in rocky sea bottoms where an anchor might foul. It is a timber hitch finished off with a half hitch.

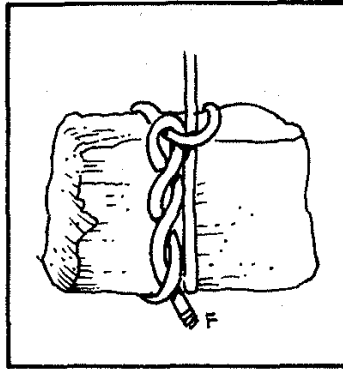

TOM FOOL'S KNOT Formed by making a clove hitch as two loops not exactly overlaying each other. The inner half of each hitch or loop is pulled under and through the outer side of the opposite loop, as indicated by arrows.

This knot can be used to improvise a handle for a pitcher by pulling the centre knot tight around the lip of the pitcher and using the loops as handles.

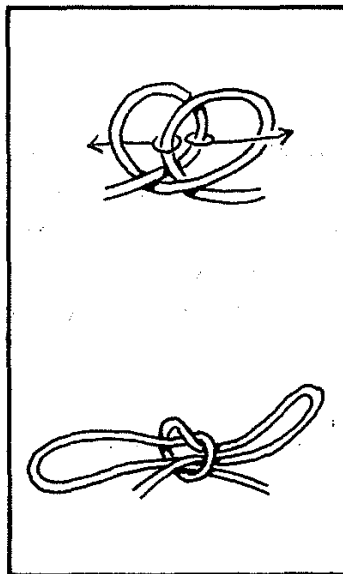

SHEEPSHANK This is a convenient knot to quickly shorten a rope.

One method of securing the end.

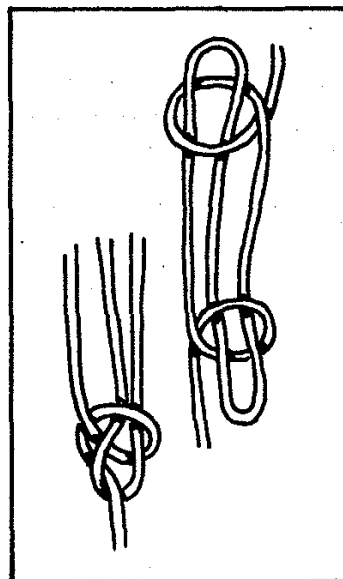

SHEEPSHANK TOGGLED The insertion of a toggle in the end bights secures the sheepshank against slipping.

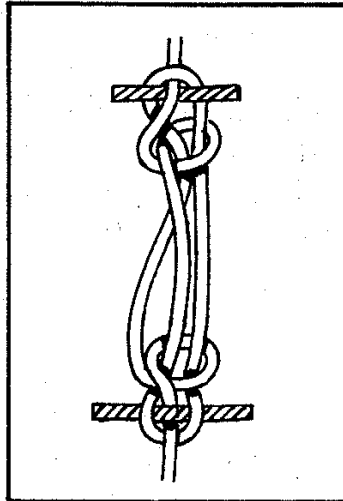

DRUM SLING A slip knot is made as indicated. The drum, can or barrel is placed in the slip knot and the free end is secured with a stopper hitch to the standing end.

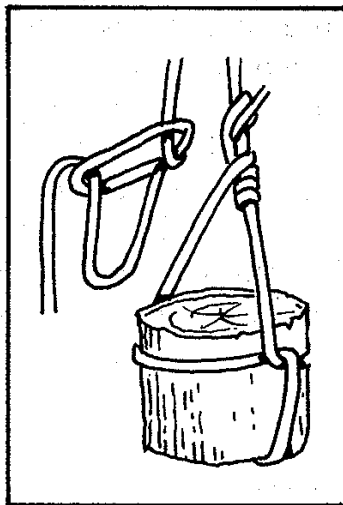

CHAIN KNOT When a rope is too long for its purpose one means of shortening it is the chain knot. Remember to put a marlinspike or toggle through the last link before you put a strain on the rope.

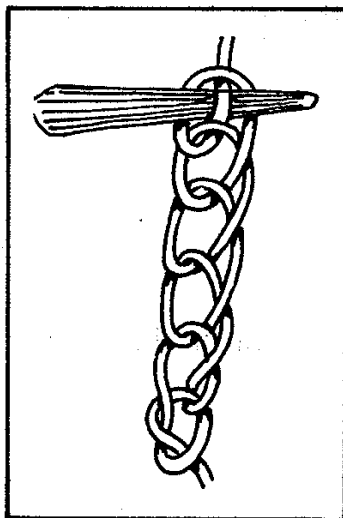

DOUBLE CHAIN KNOT This is the most ornamental of all the rope shortenings. A turn is taken round the standing end and the free end is passed through the loop so formed. In doing this a loop is formed through which the free end is brought. The end is thus passed from one side to the other through the loop preceding. It may be pulled taut when sufficiently shortened and will lock upon the last loop.

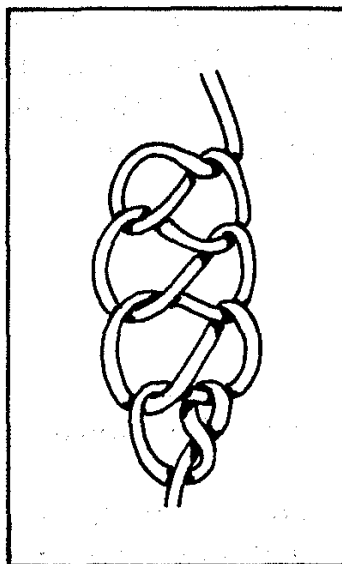

TWIST KNOT This is another easy method of shortening a rope. The rope is laid as shown and then the strands are plaited or braided together. A marlinspike or toggle is placed between the ropes in the centre to secure the hold of the plait.

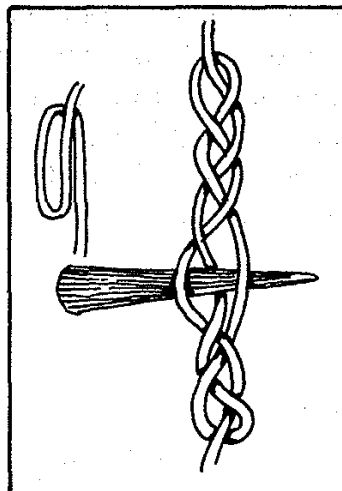

Fancy Knots

WALL KNOT Unlay the rope a few inches and then pass each strand through the bight of the strand in front. Illustration shows the wall knot ready to be pulled taut.

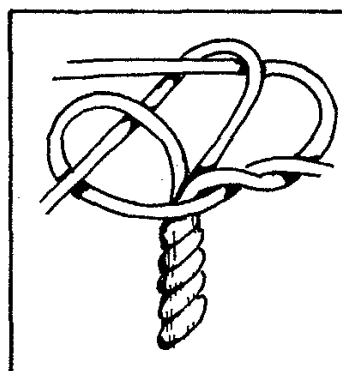

STOPPER KNOT Bring the ends of the wall knot round again and up in the centre of the knot and pull each one taut separately.

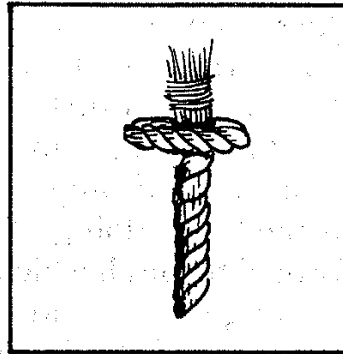

CROWNING KNOT Commence the crowning as shown here.

The crowning is now ready to be pulled taut. The strands can be back spliced to permanently secure the end of the rope against raveling or fraying. Crowning may also be used with other fancy knots such as crowning first, then pulling on a wall knot or a Mathew Walker.

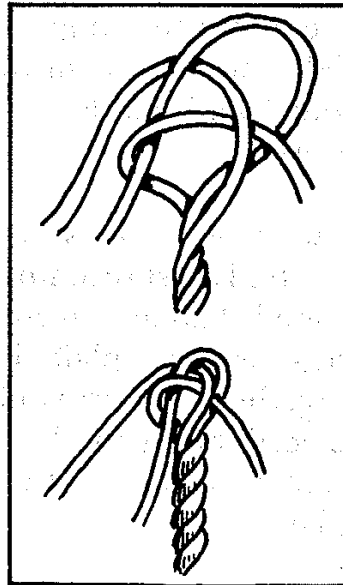

MANROPE KNOT This is a fancy knot to put a stop on the end of a rope. Top sketch shows the crowning (in the centre), the lower sketch shows the man-rope knot pulled taut.

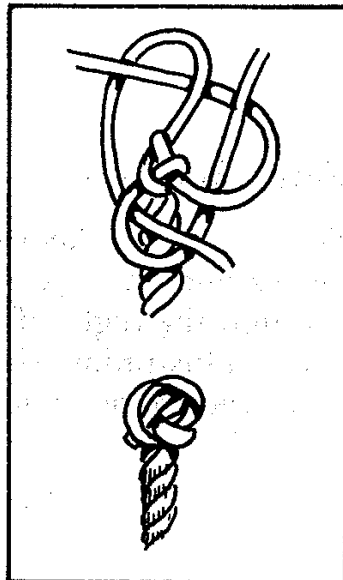
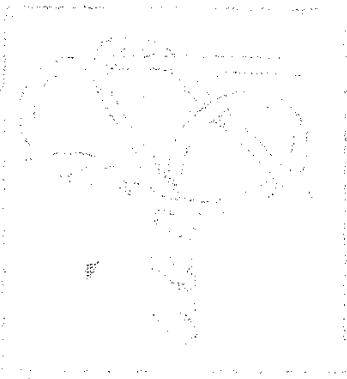

DOUBLE-DOUBLE CROWNING KNOT

This knot is started the same as the manrope, but not pulled taut. The ends are laid for a second crown above the crown (similar to the manrope knot) and with the spike the bends of the lower crown are opened, and the strands brought through these bends and pulled taut.

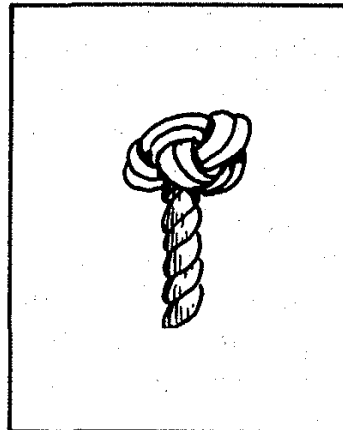

MATHEW WALKER The strands are laid as in the diagram (top) and then each in turn is pulled taut till the knot is close and tight. The knot itself is rolled up slightly to lay the twist evenly. Pull the strands tight again after this.

The Mathew Walker finished and rolled tight Fig. 2.

The Mathew Walker is reputed to be one of the most difficult of all knots to undo. The Mathew Walker can also be made some distance from the end of the rope and the strands then relaid.

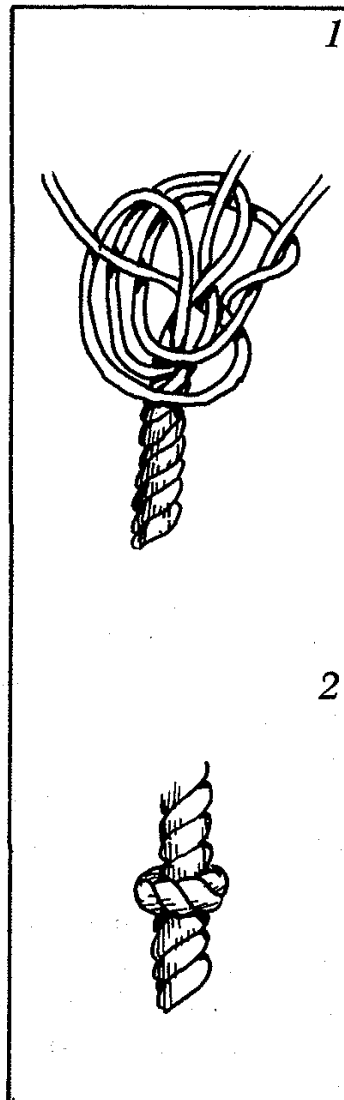

DIAMOND KNOT Like the Mathew Walker, the diamond knot is ornamental – can be made same distance along the rope. The rope is unlaied carefully. Each strand is brought down alongside the standing end, as illustrated (top). The strands are then put through the loops formed by the other strands in centre sketch. The strands are hauled taut. The rope relaid. Shows the finished diamond knot.

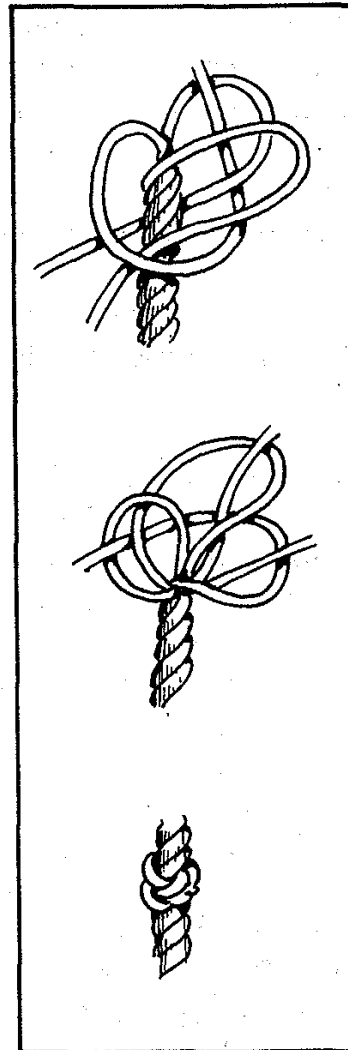

DOUBLE DIAMOND KNOT This is made as for the single diamond knot, but the strands follow the lead of the single knot through two single loops. The last strand comes through two double loops. The strands come out through the centre when the knot is pulled taut. All these stopper knots can be used for the ends of lanyards, halyards, yoke lines and also as stoppers on cleats, and for rope buckets.

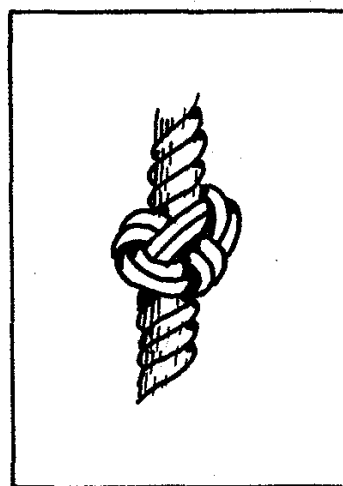

TURK'S HEAD This is a highly ornamental knot which, instead of being made with the rope strands of the rope itself, is formed with smaller cordage on the rope.

A clovehitch is made as in Fig. 1. This is made slackly to allow the extra strands to be worked through it. Pull the bottom part of the hitch above the top part and put the free end under and up (Fig. 2). The bottom strand is pulled above the top part and the free end now over and down. This repeat till the circle is complete. The free end follows round three times. The completed Turk's head is shown in Fig. 3.

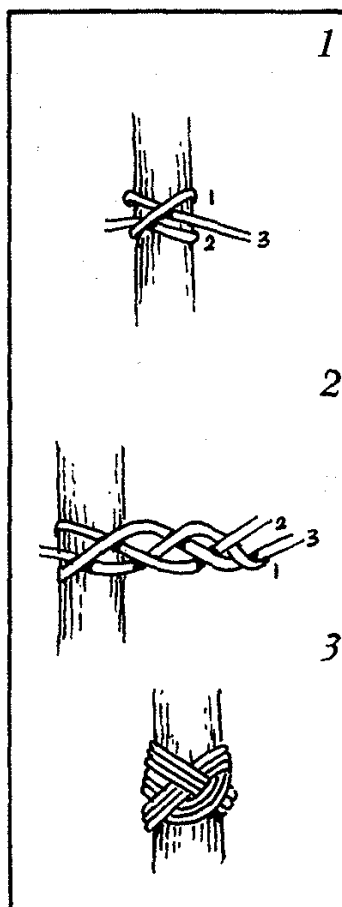

SHAMROCK KNOT This may be formed the same way as the true lover's knot, but the bottom loop is not spliced. It may be used to form three loops for stays for a mast. It may also be formed by making a knot as top sketch. The loop C is drawn up through loop D and the loop B is drawn up through the loop at A. These form the side loops and the top loop is formed naturally at E.

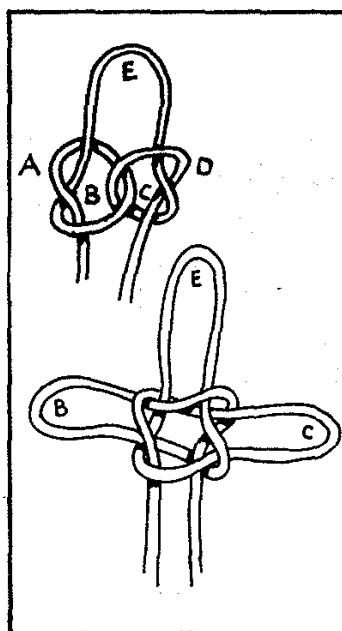

BUTTON KNOT Form two crossover hitches, as Fig. 1. Pass the loop end to the left and with the free end form another loop as shown. Now, with the free end, follow the lay as indicated in Fig. 2 and lay the strands side by side as for the Turk's head. When three to five lays have been put through, work the knot tight and use the free ends to fasten the button to the garment. A boot-lace makes an excellent button.

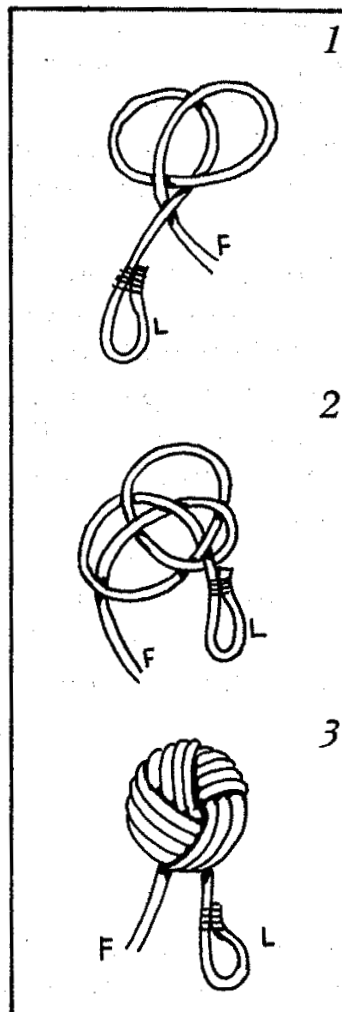

SELVEDGE To secure a block to a standing spar. The middle of the selvedge is laid on the spar and the two ends are crossed over in turns until the bights at the ends come together. The hook of the block is then put through these two bights.

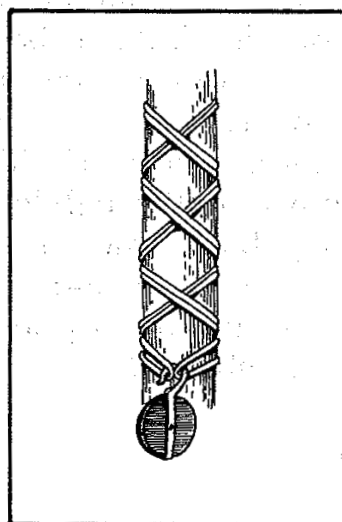

POINTING A ROPE The rope is unlaied and a tie put on to prevent it unlaying further. The strands are thinned down gradually, and relaid again. The end may be stiffened with a small stick or piece of wire. The end can be finished off with any of the crown or wall knots.

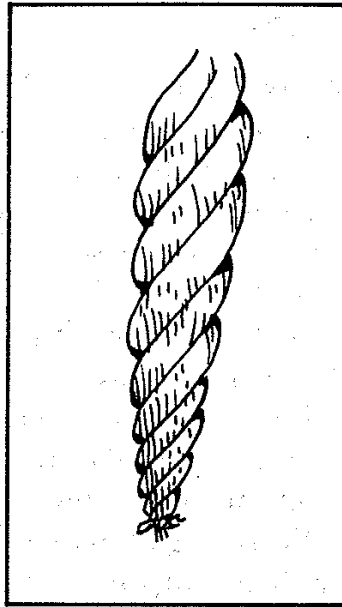

KNOTTED ROPE LADDER The length of rope is coiled in a series of half-hitches and the end of the rope is passed through the centre, as in the illustration on right (except that the coils are held closer together as for a coiled rope when it is to be thrown). The coil of half-hitches with the end passed through the centre is turned inside out, that is, the succeeding coils are pulled over each other. The coil is now thrown, and as it pays out a series of over-hand knots are made at fairly equal intervals. In making a knot ladder this is the quickest and most efficient method.

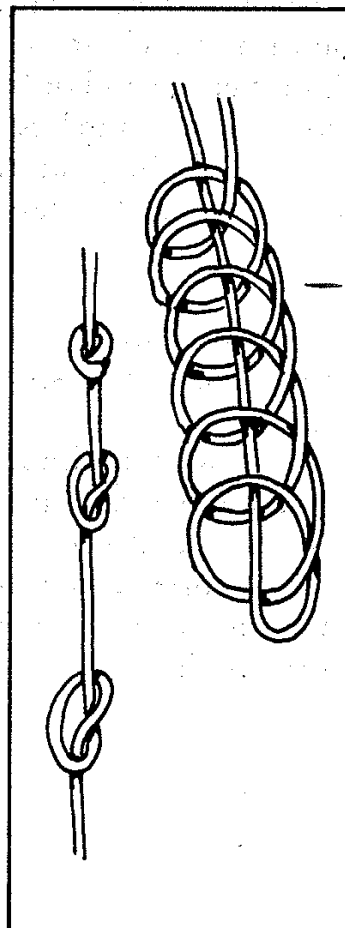

Lashings

SQUARE LASHING This is used to join poles at right angles.

Start with a timber hitch or a clove hitch below cross bar. If using a timber hitch see that the pull is straight through the eye and not back from it. Pulling back will cut the lashing material.

Put lashing material tightly around upright and cross bar about four complete times.

Frapping turns – Make about two or three frapping turns. These are turns that go round the lashing and pull it taut. These pull the lashing tight. Secure end of frapping turns either by half-hitches or by passing between lashing at the crossover and secure with a half-hitch.

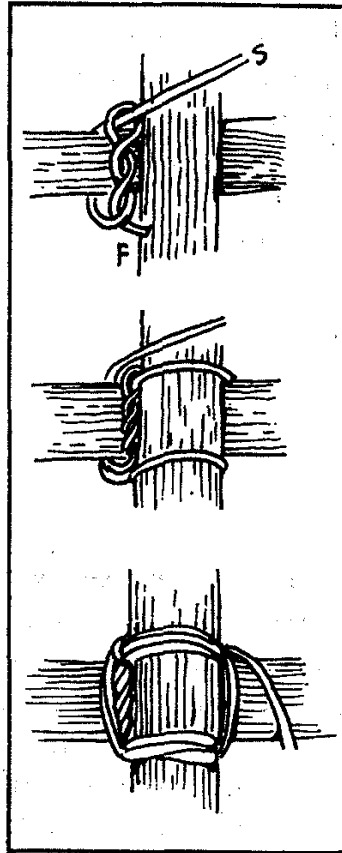

DIAGONAL LASHING This is used for bracing or joining spars at irregular angles.

Start with a timber hitch or a clove hitch and take about three or four full turns vertically.

Pass rope under top spar and make about three or four full turns horizontally.

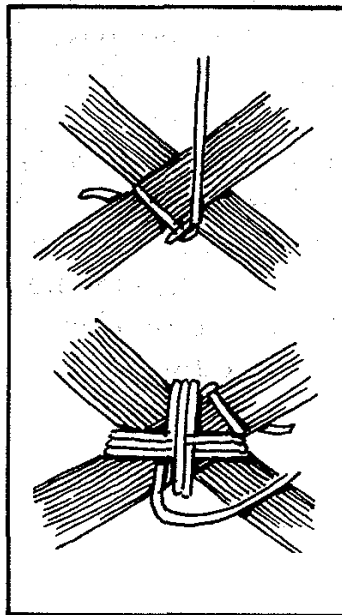

Make two or three frapping turns and either secure by two half-hitches on pole or by passing the end between the lashing and the pole and use half-hitches on the lashing.

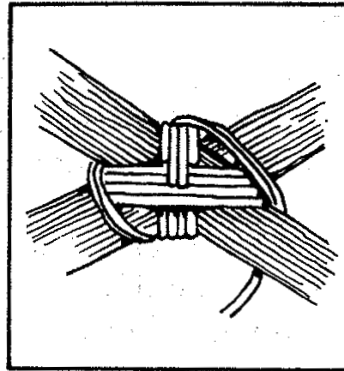

SHEER LASHING This is used to join two poles end to end. Start with a clove hitch or timber hitch and lash tightly around the two spars four to six times. Pass free end under lashings and draw tightly two or three times. Secure by passing it through itself.

There should be at least two lashings if spars are being joined together.

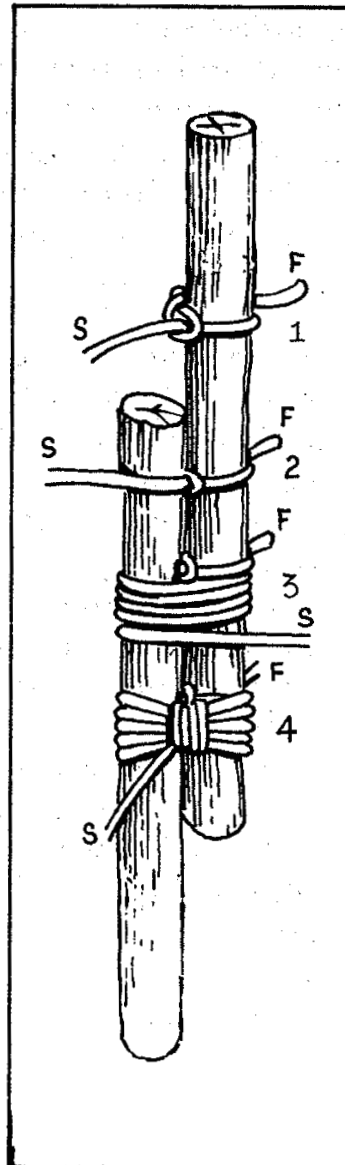

Splices

SHORT SPLICING Unlay the strands and marry them together; butt hard up to each other. The strand D first goes under the standing end of A, but over strand B and over C on the standing end. Thus each strand at either end goes over one strand of the standing end on the opposite side and under the next strand, so that there is a strand of the standing end between each short side of the splice. Continue working the free strand of each end four or five times into the strands of the standing end.

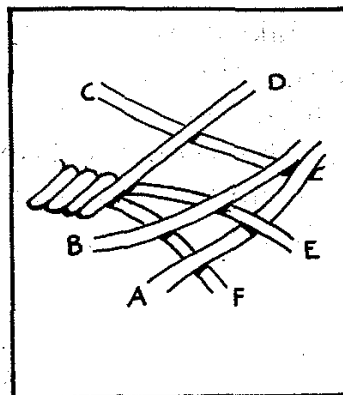

LONG SPLICING The strands are unlaied for a considerable length and then married as for the short splice. Then the one strand is unlaied and its married counterpart is laied along its place in the rope.

The two centres are simply held with a cross-over knot, and the strands thinned down and spliced as for a short splice. The end strands are finished with a cross-over knot and again the strands are thinned down and finished as for a short splice. This long splice does not appreciably thicken a rope which may be thus spliced to go through a sheave.

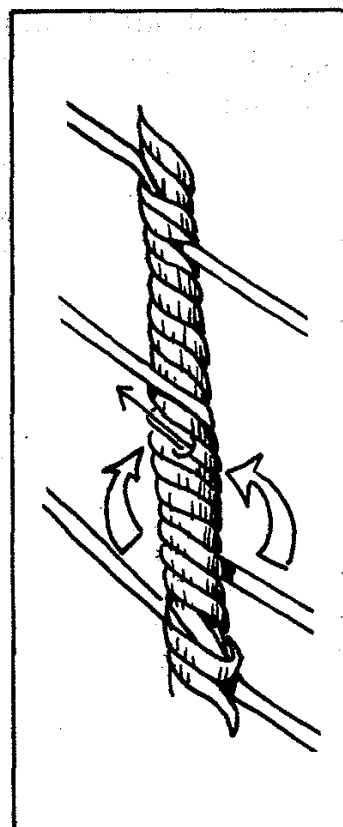

LOOP SPLICE WITHOUT A FREE END The rope is untwisted to the required place, as in top illustration. The free ends so formed are then spliced back along the rope after the loop has been formed.

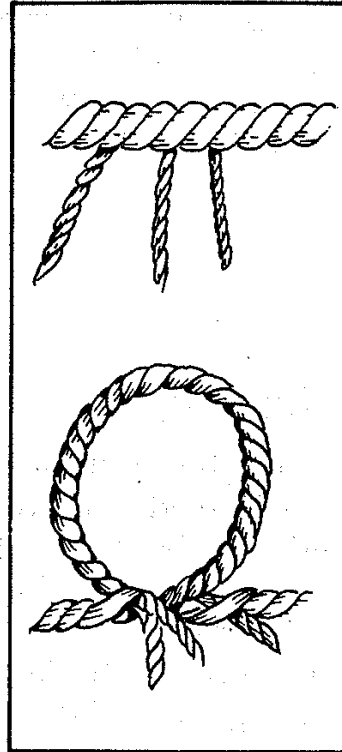

EYE SPLICE A neat eye splice can be made in a rope end by an ordinary short splice after the loop or eye has been formed.



LOOP SPLICE The strands are unlaid and laid side by side till the loop is the required length. The strands of the free ends are spliced into the ropes of the standing ends as for a short splice.

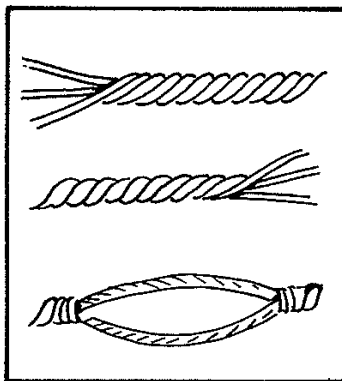

Toggle and eye – showing one application of splicing and whipping. Toggle is spliced and eye is whipped in sketch.

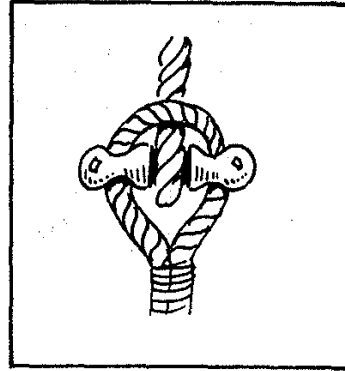

Whipping

Before the finish of the binding a loop formed from the end is laid under the binding at the start. This end is bent back to form a loop and the last six to twelve turns bind over this loop. At the last turn of the binding the cord is put through the loop and the free end of the loop is pulled tightly, thus drawing the end of the binding beneath the last turn.

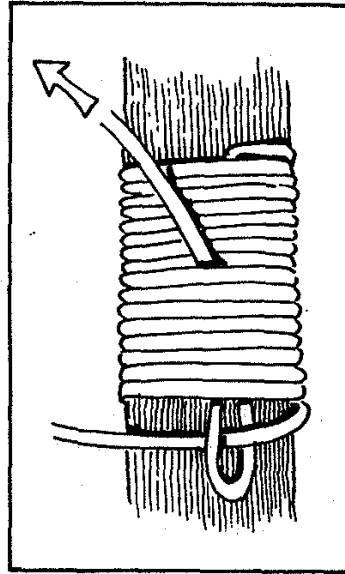

Another method is to pull the binding taut, and then the two free ends are cut close in. The whole binding is smooth and neat.

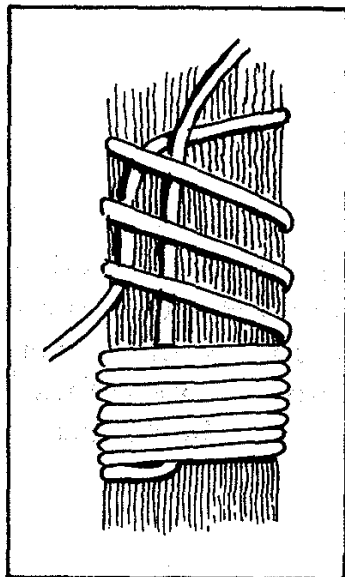

Netting

Hammocks and nets are made by the use of netting needles and a mesh stick. The netting needles (as shown in the illustration) can be made from a thin piece of hardwood or bamboo. The needles themselves can be from 20 to 30 cm long and 20 to 25 mm wide. The mesh stick can be about 13 cm long, oval and from 5 to 200 mm wide. The netting cord is put onto the netting needles as for an ordinary shuttle. With needle B and with needle A the cord is looped around the pin in the centre of the eye.

At one end of the string, tie a loop and place the knot on a conveniently high nail or hook. The mesh stick is put under the loop and the needle with cord passed through as in Fig. 2. The needle and cord are passed in front of the loop formed in Fig. 3 and under the original loop, while at the same time the other end of the cord is held on the mesh stick with the thumb of the left hand. The knot is pulled taut.

A succession of these loops are formed until the requisite width is reached, then this first series of loops are placed through a rod or cord, and the loops are netted on to them until the requisite length is reached.

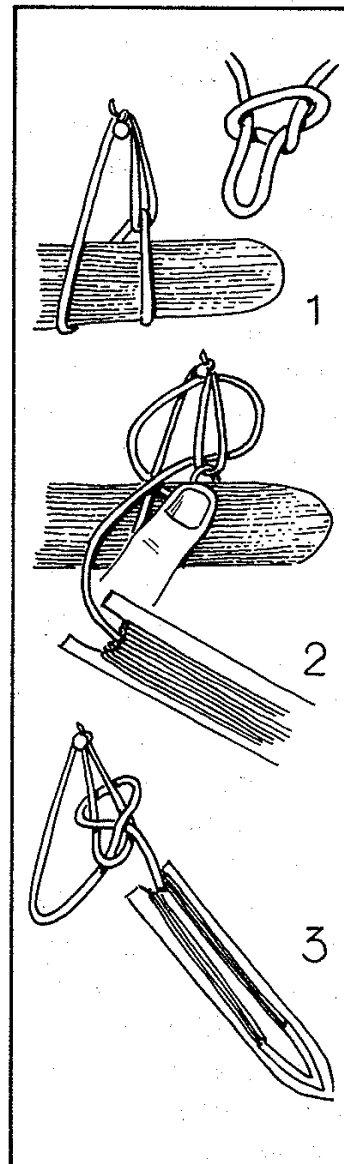
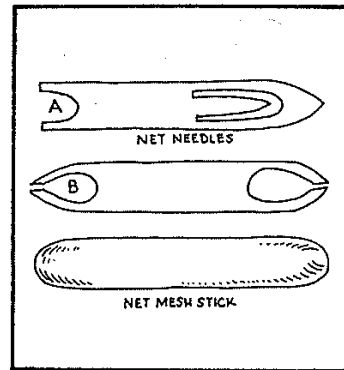

3 Huts and Thatching

Because of the lightweight nylon tent revolution over the past twenty years few people deliberately embark on a bush trek without a roof over their heads. These manufactured shelters are extraordinarily light. For instance a two-person tent with covering fly, plus its aluminium poles and pegs, can weigh as little as 1.5 kg.

Given this fact it is inexcusable, not to say, in a conservation sense, stupid, to make a bush material shelter under normal circumstances. But sometimes circumstances are not normal. Then the ability to construct a weatherproof temporary hut may save one's life.

Little skill is needed to make a comfortable, thatched, weatherproof hut using materials at hand in any sort of country outside of the stony desert regions of Australia.

The building of a thatched hut from local materials is a creative exercise. Design must provide for the anticipated weather conditions. Although finding suitable materials almost anywhere presents no problem, considerable organisation is required to collect this material. And for the actual structure itself, good teamwork is needed.

It should be remembered that many of the early white settlers lived half their lives in bush structures when clearing their own land. There is a lesson here for Australia's new back-to-the-earthers and smallholders. Although some local councils frown on these temporary dwellings, a bush house or hut will often give valuable service once the reason for its initial erection has ended. And, unlike an old municipal bus or a stripped caravan, it will blend into the environment of the block.

Thatched Huts

The making of huts and shelters for occasional or continuous use from exclusively local materials and without the aid of any man-made equipment is not difficult. In place of nails, lashings (either of vine, bark strips or other fibrous material) are used. Framework is of round poles. Weather-proof roofing is provided by thatching with long grass ferns, reeds, palm leaves, seaweed, bark sheets, split shingles or even sods of heavy clay turf.

The material used depends on the location. The shape, size and details of the hut are likewise governed by the length of intended occupation, the number of people that have to be sheltered, the local climatic conditions and, of course, the time available for construction.

If there are one or two people to be sheltered for a few nights only in a temperate climate, a simple lean-to thatched shelter will suffice. This can be built in one to three hours. But if there are eight or ten in your party and they require shelter for a few months against cold and bad weather, then a semi-permanent hut complete with doors, windows and a fireplace for heating and built-in bunks will be required. To make such a structure properly will require work over two to three weeks — even longer if one is using rammed earth or pisé.

In making any dwelling it has to be assumed that a good knife, a machete and an axe are available to every member of the working party and that all the workers are, of course, willing.

The structures discussed here are merely examples of what can be done. When it comes to planning your own hut you are your own architect and builder. If there are several people in the party organise the labour so that no hands are idle. Have one or two people cutting poles, another carrying them to the site, a fourth stripping bark for lashings and set the others gathering material for thatching.

Collect all the material for the structure before you start to build. Then stack it in orderly piles as close as possible to

the cleared building site. Your main poles should be in one pile, the battens for thatching in another, the bark strips or vines shredded down for immediate use in a third, and your thatching material in several piles.

In the meantime the building site should be thoroughly cleared of ground cover and, if necessary, levelled. Under normal conditions spades and mattocks are the rule. But in an emergency digging tools may have to be improvised by using bush timber.

Once you are ready to start building, have every person in the team on the site. Organise the erection of the main framework and then break your team up into small gangs for lashing on the battens and completing the framework. This way you will save hours of labour and you will succeed in building a better hut.

There is nothing to it really except intelligence. Plan and organise to keep everybody busily engaged.

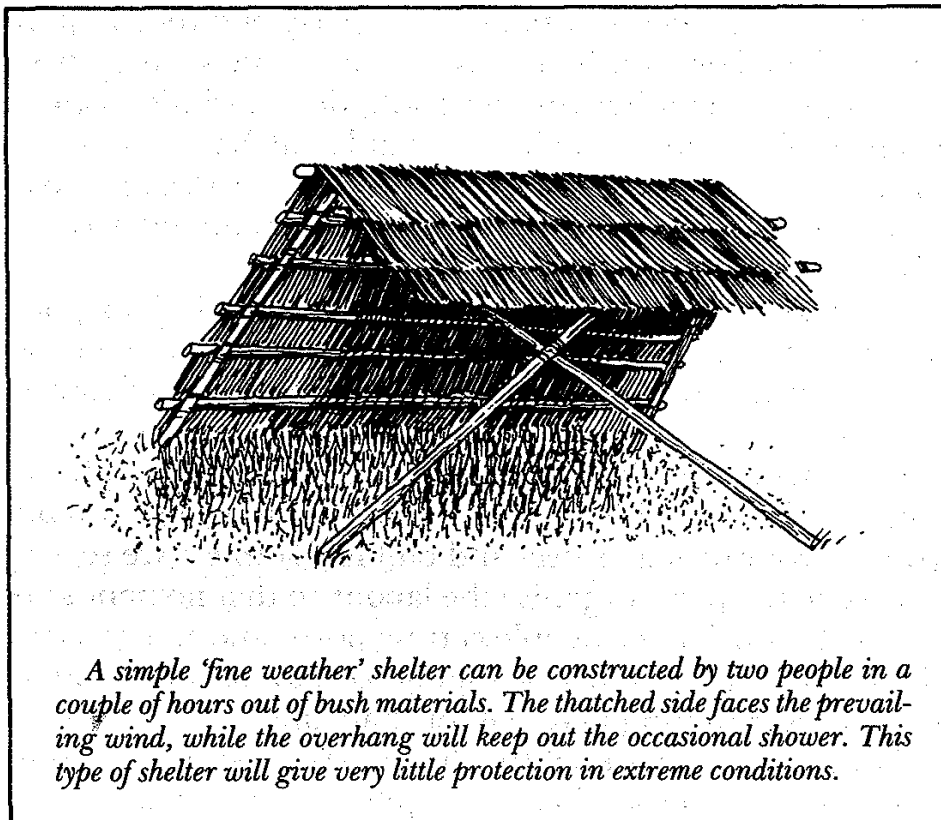

A simple 'fine weather' shelter can be constructed by two people in a couple of hours out of bush materials. The thatched side faces the prevailing wind, while the overhang will keep out the occasional shower. This type of shelter will give very little protection in extreme conditions.

DESIGN There are three main designs of huts: a simple lean-to, suitable for fine, warm weather; an enclosed round hut or pyramid, suitable for cold conditions; and a long hut suitable for sub-tropical and tropical climates if left open, or, if completely walled, suitable for cold conditions.

Refinements such as doors and windows may be added as needed. And when the hut is completed there is the all-important matter of furnishing it. But first let us look at what the bush dweller can build as the first protective shelter.

SECTIONAL LEAN-TO HUTS Small one- and two-person huts can be easily constructed in an hour or two by making and thatching two or three frames, from 2-3 metres in length and 1-1.5 metre in depth.

These frames, built of battens, are lashed onto two forked sticks. The forks are in the form of hooks at the upper end. The framework is simple to construct.

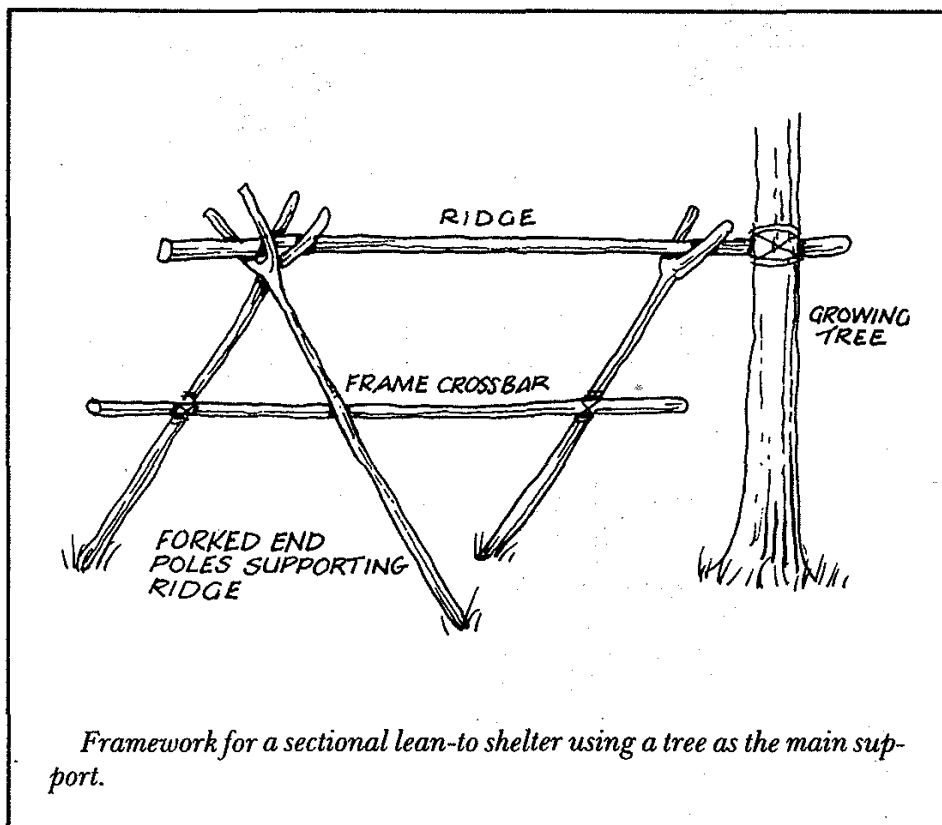

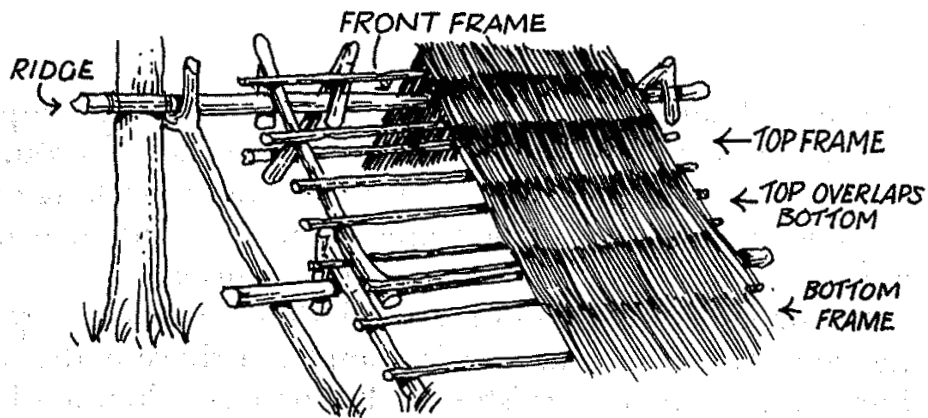

Thatching of a lean-to shelter showing how the thatched sections attach to the crossbar and ridge.

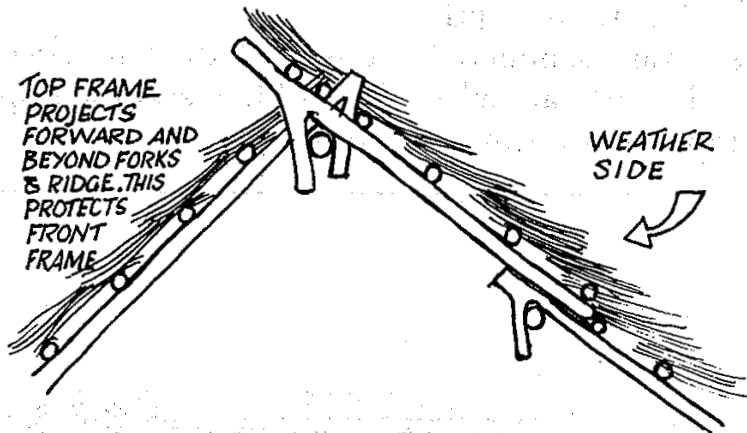

Assembly of thatching on a lean-to shelter. Note how the top frame projects forward and beyond the fork and the ridge itself to protect the front frame.

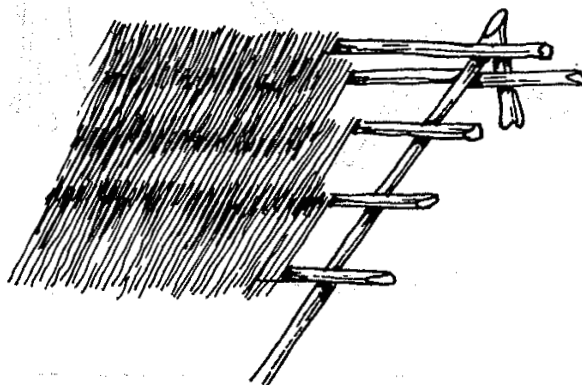

Another view of the assembly of a simple lean-to hut.

It is important to ensure that the end of the top frame projects forward beyond the fork and the ridge. This protects the front frame and saves the work of ridge thatching. If raised bunks (see Chapter 4 Campcraft) are being put in, it is advisable to have the bottom of the thatch about 50-60 cm above ground level. This raises the ridge height between 30-50 cm. The length of the side poles in this instance is increased to 4 metres.

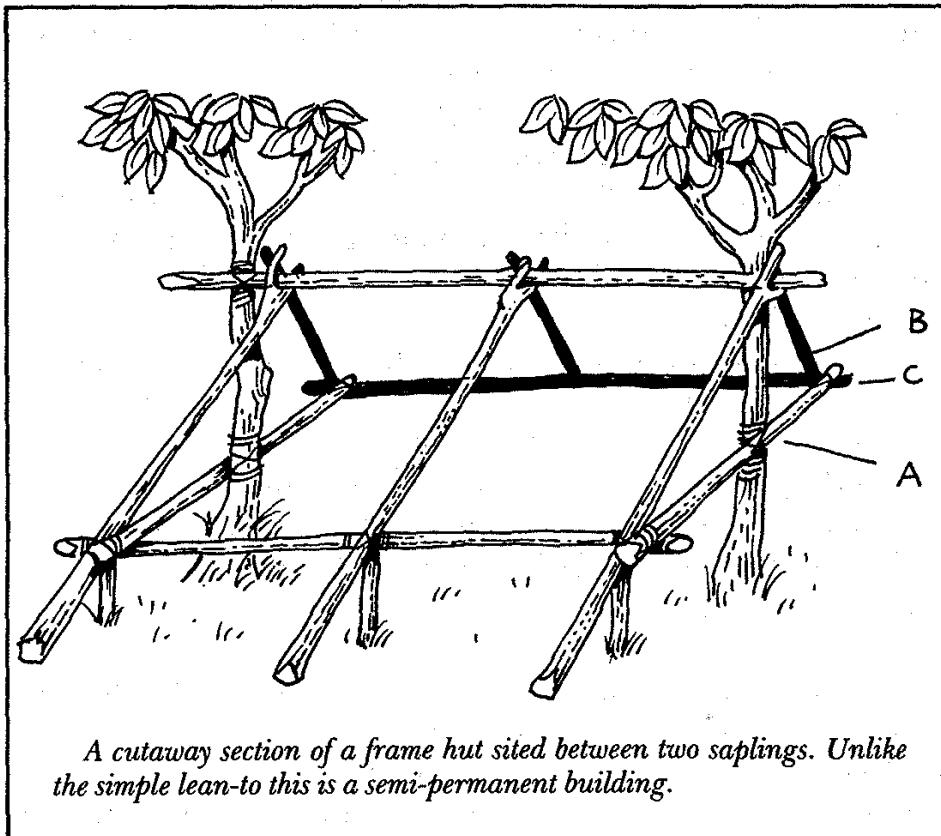

PERMANENT LEAN-TO HUTS The permanent lean-to hut using a tree for bracing is simple and quick to erect.

The ridge pole is raised against the tree by the means of the two end-forked poles to the required height of about 3 metres, depending on the width of the structure. The end-forked poles should be at an angle of not less than 45° . If the length of the ridge is more than 4 metres it is advisable to put in another one or two forked poles about halfway along.

On to the end-forked poles lash a crossbar (A in the illustration) and lash it again to the upright tree. This crossbar has lashed to its front end, a pole (B), connecting and lashed to the ridge and also the front eaves, pole (C), plus the front thatching battens.

Thatching battens are lashed onto the two rear forks. The distance apart for the thatching battens varies. It may be anything from 15-30 cm, depending on the length of the thatching material being used. A general guide is that battens should be spaced apart about one-fourth of the average length of the thatching material.

An upright in the form of a light fork may be placed under the front corners to the front eave pole. Wall thatch battens are lashed horizontally from the rear forked poles to this upright. Wall pegs are driven in along the rear at whatever height is required and to these wall pegs thatching battens are also lashed.

Forked poles should not be less than 7-10 cm in diameter; the ridge pole should be about the same and thatching battens should be 3-5 cm in diameter.

Use dry or dead timber wherever possible. It is lighter to handle and its use avoids any destruction of the bush. When making wall pegs, bevel off the head. They can be driven in without splitting.

ROUND HUT To make a standard round thatched hut cut or gather four poles each about 5 metres in length and between 10-15 cm thick. They should be as straight as possible.

Lash these together in the shape of a tepee or pyramid, stand them upright and then sink them into prepared holes in the ground — a depth of 30-50 cm is usually ample depending on the firmness of the soil. In sandy conditions the depth may have to be greater to ensure stability.

The distance between the diagonal poles should be about 6 metres to ensure a roof slope of about 45°. This is the best for shedding rainwater from the yet-to-be-constructed roof.

Another eight poles, which can be somewhat lighter, are added to the initial pyramid. They should be spaced evenly

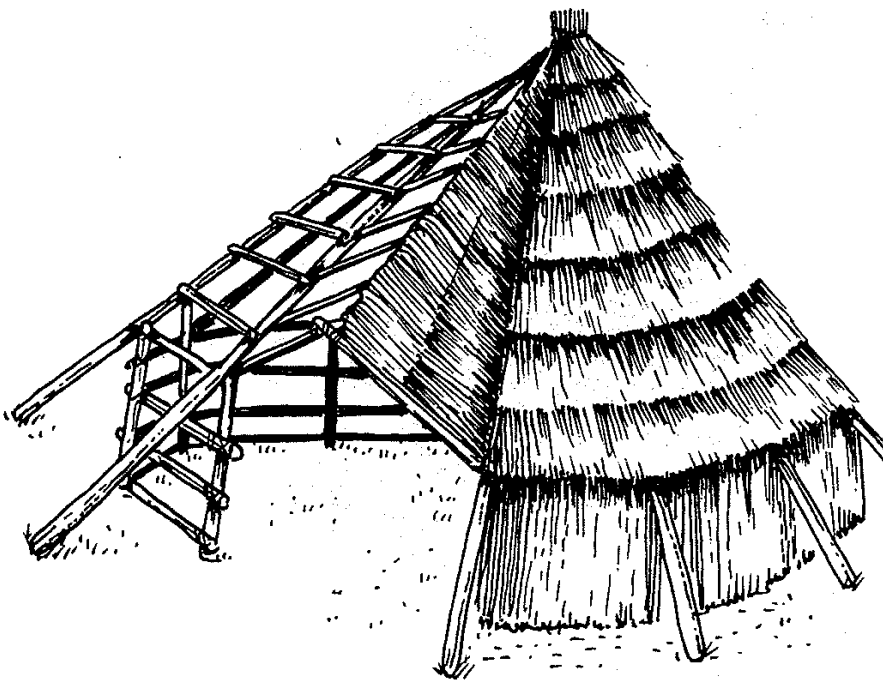
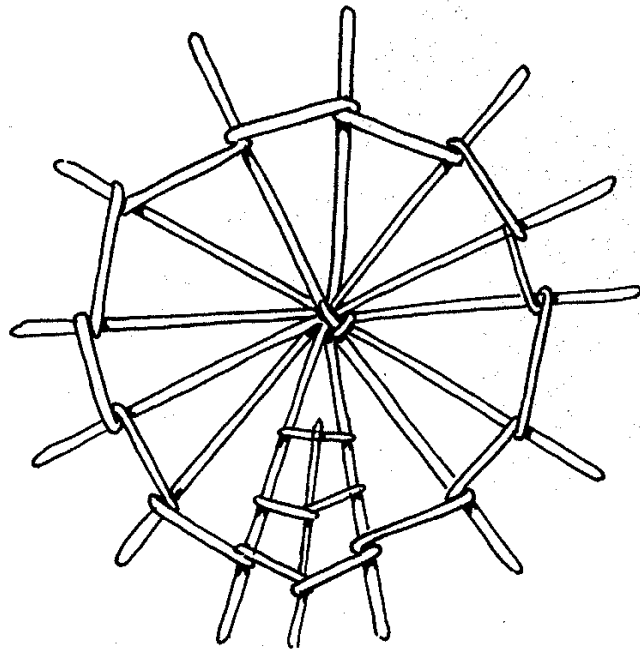

The round hut, showing the placement of the framework and the finished construction.

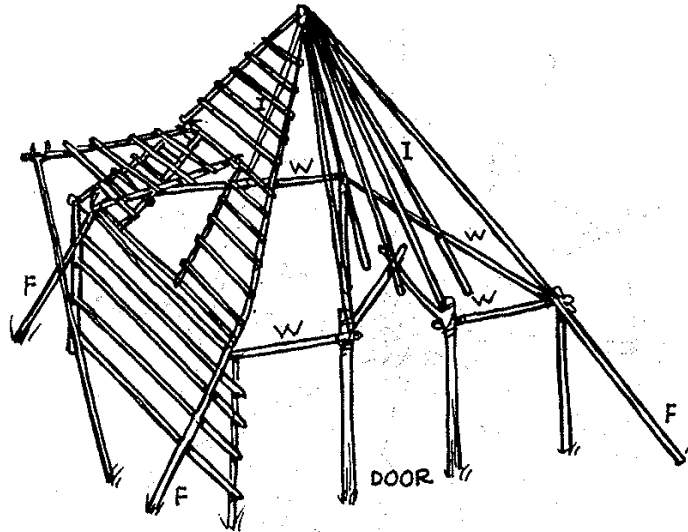

W - WALL RAIL
 I - INTERMEDIATE POLES
 F - FORKED CORNER POLES

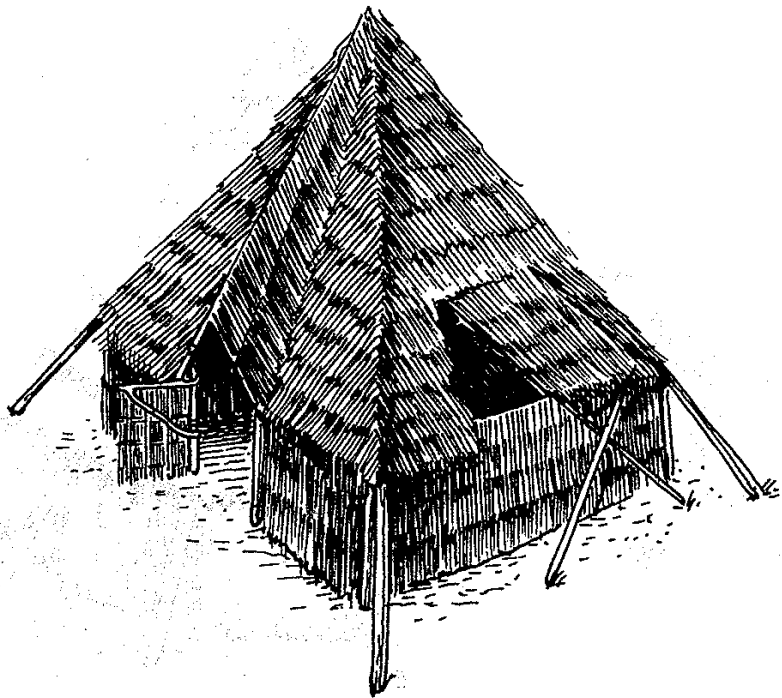

The pyramidal hut showing the skeleton, complete with opening window and the raised doorway. The second illustration shows the hut when finished. This is an excellent 'cold-weather' hut but takes at least three days to build.

around the circle. These should be lashed to the roof poles after being driven into the ground. These main structure poles should then be strengthened by cross battens and the inside wall supports constructed within the circle (see illustration). Space can be left for a tall or low entranceway as desired (the low one is easiest).

The hut should then be thatched with any materials that are available.

PYRAMIDAL HUTS The pyramidal hut, having a square base, is particularly useful where it is desired to make the fullest possible use of wall and floor space.

The pyramid and circular hut have similar construction techniques. In the pyramidal hut, when tying on the thatching battens, it is more efficient to make one lashing at each corner secure on the thatching battens. When the span between the forked poles becomes less than 2 metres it is best to lash only onto the corner poles, omitting any extra tying to the intermediate poles. If the span between the corner poles is greater than 2 metres it is necessary to lash battens to the intermediate poles.

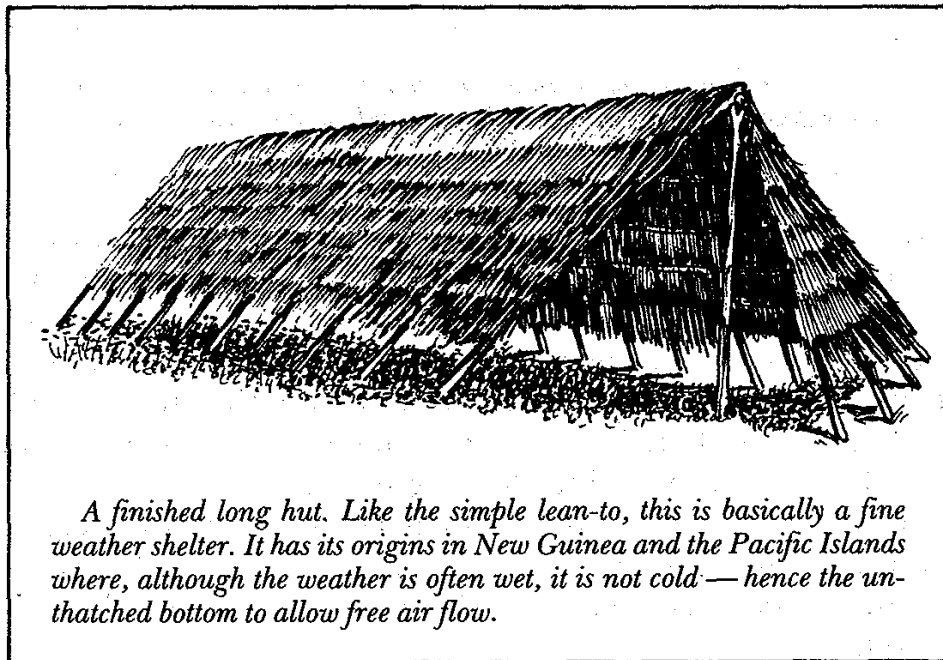

A finished long hut. Like the simple lean-to, this is basically a fine weather shelter. It has its origins in New Guinea and the Pacific Islands where, although the weather is often wet, it is not cold — hence the unthatched bottom to allow free air flow.

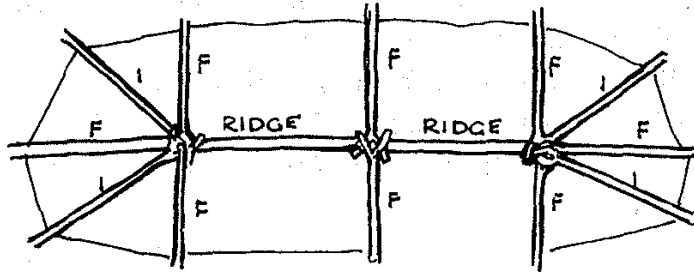

Basic structure plan of a long hut as seen from above. Intermediate support poles are needed for the ridge if the forks are more than 2 metres apart.

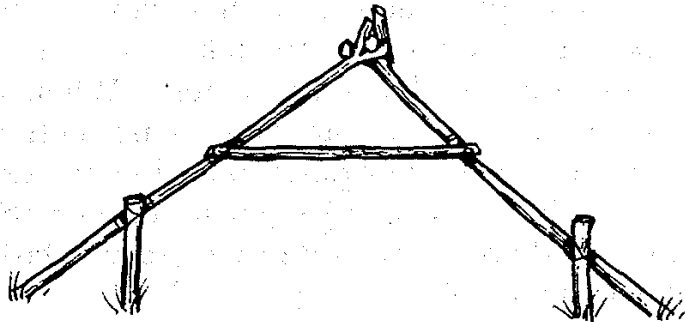

A cross-section view of the construction of a long hut. When the span is more than 3 metres, lash collar ties onto forks and intermediate poles.

LONG HUT The end portion of this structure is basically the same as a one half section of the pyramidal hut. The length can be extended to any required distance by lengthening the ridge pole and by using additional supporting forked poles. If the ridge is extended in two or more lengths, they should be lashed together. It is also advisable to notch the ridge so it will sit snugly in the interlocking forks.

Wall pegs should be driven in at a convenient wall height and thatching battens are lashed down. Refinements, such as lift-up sections for light and ventilation, can be added if required.

POLES AND STRUCTURES All sloping sides on any hut must be completely waterproof and should be at an angle of not less than 45° (although a 40° slope will shed water). A slope of 45° will also give good headroom in the larger huts.

The diameter of the timber inside the bark can be roughly calculated by allowing a minimum of 2-3 cm diameter at the butt for each 120-150 cm of length. Thus if a pole is 3 metres long the diameter of wood clear of bark at the butt should not be less than 6 cm, or, if the pole is 6 metres long, the diameter at the butt should not be less than 12-13 cm.

If the span is relatively wide or the timber used is relatively light, strengthen the structure and prevent sagging or inward bending of the main poles by putting across ties or collar ties so that the thrust or weight is thrown from one pole on to the pole opposite.

BRACING If long or lean-to huts are being built and there is no strong support, such as a growing tree, it is advisable to lash in diagonal braces that extend if possible from the ground at one end to the ridge at the other. These bracings will make even a light hut stormproof.

DOORS AND WINDOWS Refinements such as doors and windows are completely practical and also possible in thatched huts. Very little extra work is involved.

Windows are simply two or three forked sticks cut off short below the fork with the long end projecting.

Thatch battens are lashed to these forked sticks and the framework is lifted up and hung on one of the battens of the hut itself.

In the general thatching of the hut this window space is left clear. The window frame is itself thatched separately as a complete unit.

It is best to make the window frame wider than the window opening of the hut itself. It can be propped open by the use of one or two sticks. However, if it is very wide more props may be needed.

There should be at least 15 cm overlap of the window and

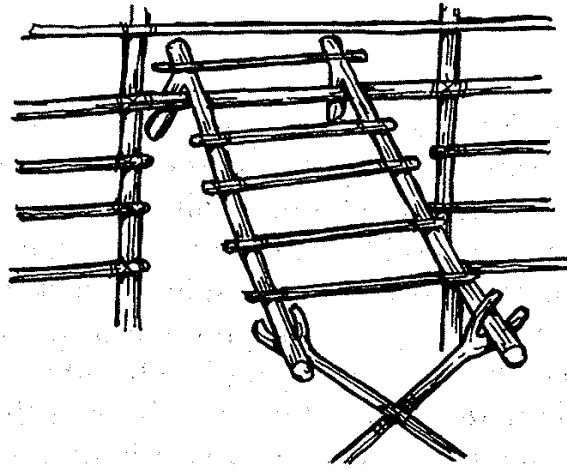

The method of making window frames. They are hooked onto a thatch batten above the window opening.

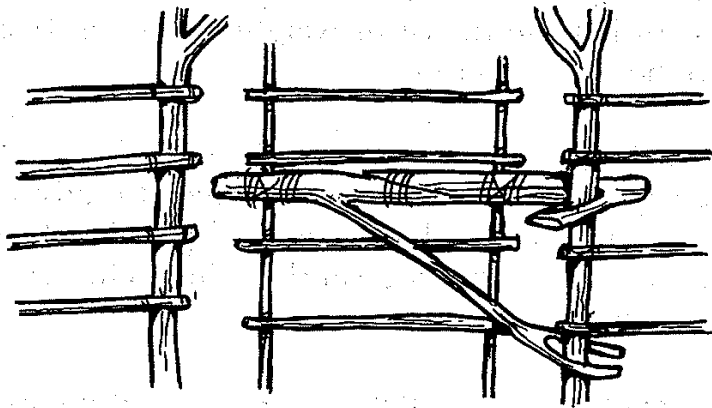

Door frames are 'hinged' by a combination of hook and fork. The method is similar to a campfire swinging frame used to support a billy or other cooking vessel.

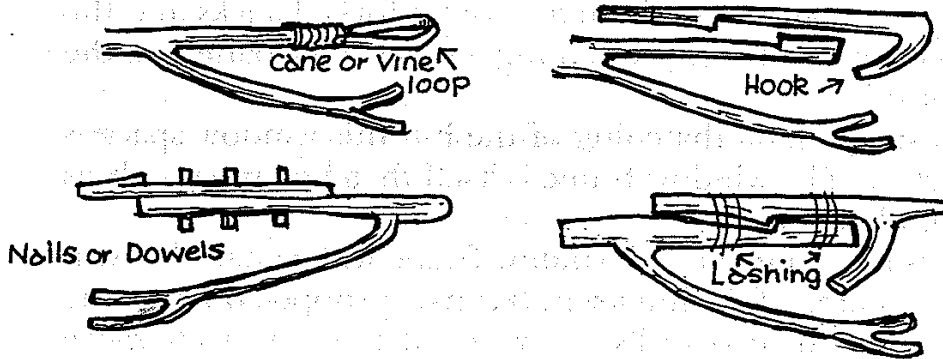

Different methods of assembling the door frame hinge. Top left shows a cane or vine loop used with the forked branch. Top right illustrates how a hook can be cut into a straight branch. The bottom two illustrations show different methods of lashing — the left with nails or dowels and the right by lashing.

the roof thatch at the sides. The loose ends of the thatching above the window frames should be allowed to come on to the window's own thatch and should completely cover the sewing at the top.

Doors are also made and thatched separately. The hinge of the door can be made by several methods (see illustration). In construction they are similar to a gate frame with the addition of two uprights lashed across the fork. To these two uprights the horizontal thatching battens are secured.

TREE SWING SHELTER In swampy country or in areas which are badly snake infested a very simple swinging bunk can be made by one person in a day.

The forked pole that supports the bunk must be very strong. Either a cane or a vine loop may be used at the top

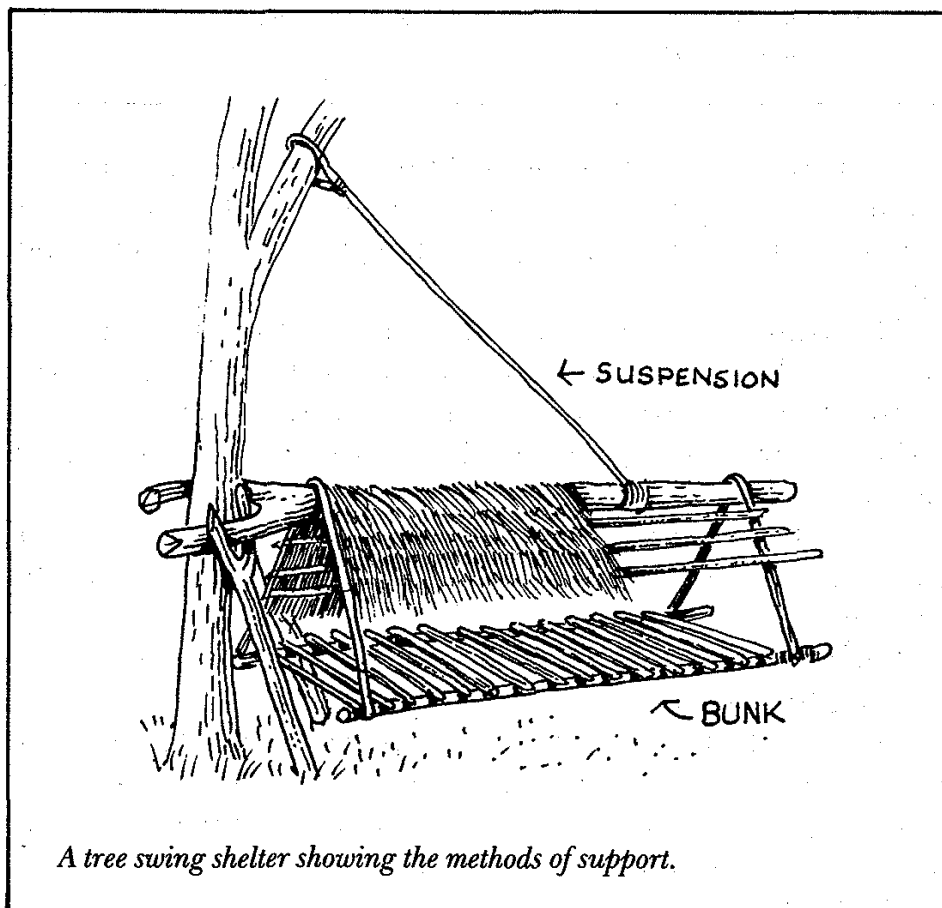

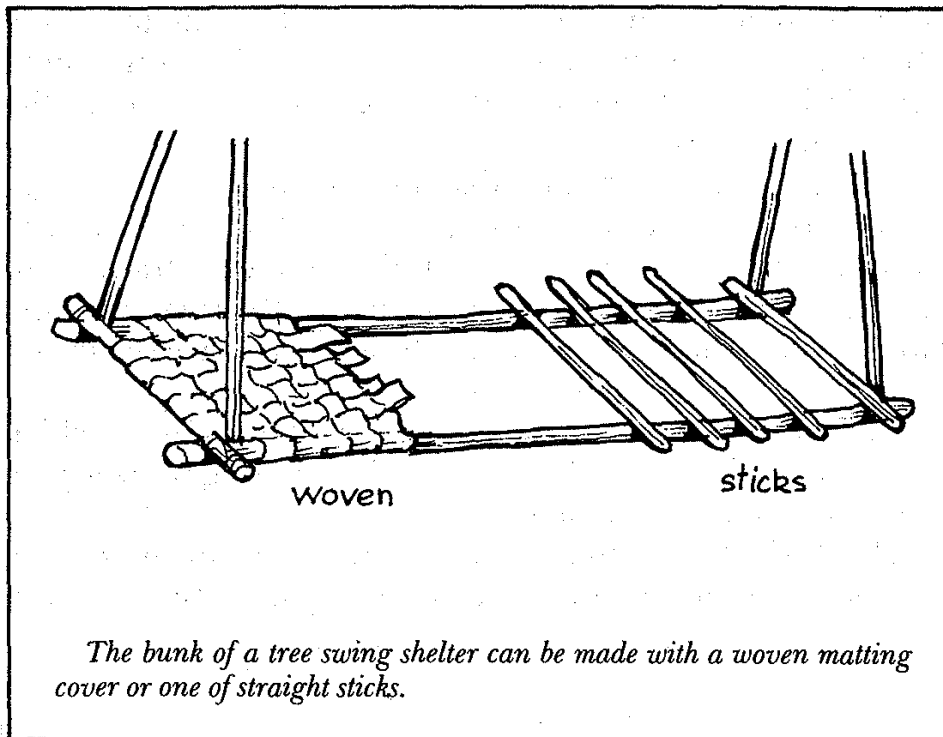

section. It is also advisable to have a vine or cane rope as additional support stretching from the end of the main frame as high up the tree (preferably to a fork) as is practicable.

The frame poles for the thatch battens are lashed separately, with a square lashing, to the bottom of the forked frame pole. In order to give rigidity a short, cross stick is lashed horizontally to each of the opposite sides of the frame poles.

When thatching, work one row along one side and then the row on the opposite. This will help strengthen the framework and keep it correctly balanced.

The bunk is made separately and then attached to the supporting forked pole.

Its main frame is simply four poles lashed together to form a rectangle about a metre wide and a metre or more long (depending on the body length of the person using it). The space between the poles can be either woven or made with crossed sticks.

THATCHING MATERIALS Materials suitable for thatching range from long grass, reeds, rushes, most of the long stalked ferns (such as bracken), palm leaves of all types and, as a last resort, many pliant, leafy branches.

Long grass and reeds make a high quality roof when they are used dried rather than in their green state. It is advisable when using these materials to cut and stook them at the very start of your building project — particularly if it is a large job spread out over two or more weeks. This enables the material to dry out before being used.

If placed on the roof supports in their green state, grass and reeds will shrink and curl, allowing rain to enter. All green materials shrink and this will affect the thatching stitches as well, causing them to become loose. The thatch can then slip out of the stitches and in the first half-decent wind it will blow away.

If the materials are well-seasoned the stitches will not slacken because there is very little shrinkage, and the thatch will stay down securely.

With most of the brackens it is advisable to use the material when it is green and sew it down tightly. This also applies if you are forced by circumstances to use green branches.

Green branches do not make a very efficient roof and their use is not recommended except in an emergency.

In a general way using bracken and reeds for thatching is good service to the land.

Bracken destroys pasture and reeds choke watercourses. Unfortunately simply lopping both has no effect on their growth. They have to be dug up completely.

If branches of trees or shrubs are to be used seek out a dead branch with some of the leaves still on it. Shake the branch. If the leaves immediately fall off the material is useless and will only serve for a day or two. If the leaves withstand this shaking the plant will probably serve your purpose fairly effectively. Some trees and shrubs drop their leaves within a few hours of being cut. These are also useless.

Palm leaves are best for thatching when they are dead and dry. It is quite usual to find large quantities of them scattered

at the base of the tree. They are excellent material but can be somewhat brittle and inclined to break at the height of summer.

The best time to collect dead palm leaves for thatching is either early in the morning when the leaves have often been softened by an overnight dew, or after rain. It is also advisable to wet them down if possible before sewing them on the thatching battens. This softens the brittle leaves, makes them lie flat and ensures that you get a better coverage.

THATCHING METHODS There are almost as many different methods of thatching as there are different materials. Each method has its own peculiar advantage and application for certain types of material.

The methods you are most likely to find of use are two simple ones. In the first the material is sewn on to the battens. This is called sewn thatching. The second method is to attach it in bundles. This is called tuft thatching.

Instead of sewing the thatch onto the battens it might be more convenient to tie a pliant stick onto them at convenient intervals. The pressure of this stick tightly tied to the batten holds the material securely. This is known as stick thatching.

There are several methods by which the materials can be secured to the battens on the ground. The battens are then laid onto the framework overlapping rather like long tiles.

With some of the palms, the stalk itself may be used either as the thatch batten or to hold the leaf itself in the desired position.

PRINCIPLES OF WATERSHED IN THATCHING Thatching may be either to give shade or to give protection against rain. Thatching for shade presents no problems. If it is thick enough to break up the sun's rays that is sufficient.

Thatching for protection against wind or rain however, will be effective only if certain principles are observed. It is instructive to watch the behaviour of drops of water on a thatched roof. The drops run down the topmost strands until they come to the very edge of the blade of grass or other

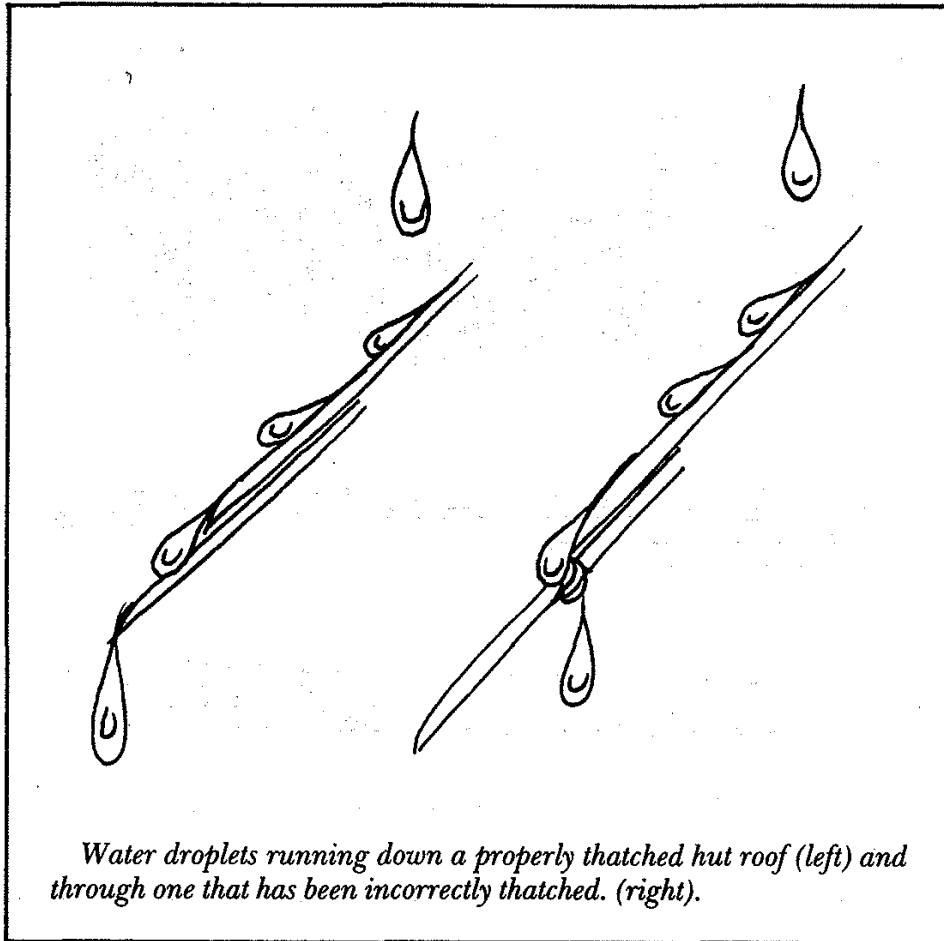

Water droplets running down a properly thatched hut roof (left) and through one that has been incorrectly thatched. (right).

material. There they increase in size and when they are big enough fall off onto the blade immediately beneath.

If the stitching interrupts the smooth, continuous course of the water droplets they will follow its line because it is at a steeper angle. The drops will creep along the stitch and when they reach its lowest point on the underside of the thatching each droplet will again increase in size until it is too heavy to remain attached to the sewing material. The roof then, of course, leaks. Thatch will never leak if the stitching material is properly covered.

It is the quality of 'coverage', rather than the thickness of the thatch, that makes a natural roof waterproof.

Windproofing, on the other hand, depends largely on the 'tightness' and thickness of the thatching.

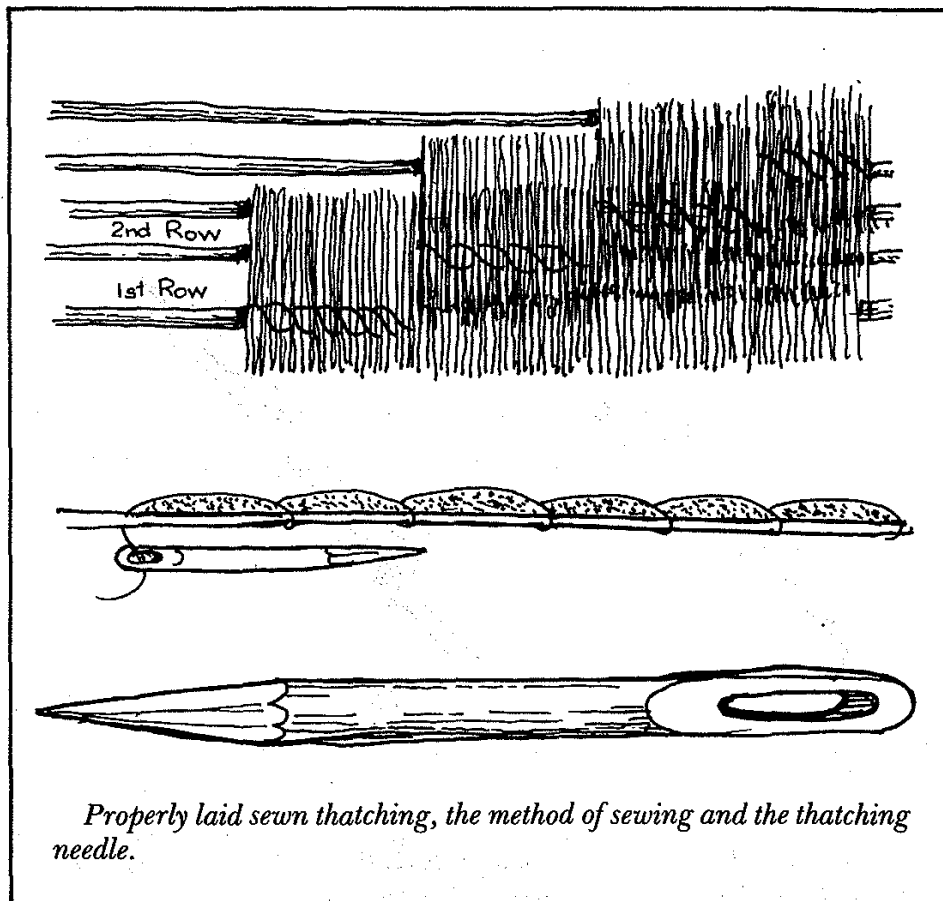

SEWN THATCHING Sewn thatching is started by stitching at the bottom of the first layer of thatch on the lowest thatching batten. The second layer must lie on top and cover the stitching of the first row and include the top section of the underneath layer of the actual stitch.

It is better to have each layer held by three rows of stitching. The stitching of every row must be completely covered by the free ends of the layer above it.

To sew thatching, make a thatching needle by cutting a dead, straight-grained stick about 3 cm thick and about 50 cm long. Sharpen one end and rub it as smooth as possible on a stone. Narrow the other end until it is about 5 mm thick. Before doing this, however, cut an eye in this end. If you cut the eye first it will not split out when the end is pared down.

Lay the thatching material with the butts towards the roof

and the lower end on the lowest batten. Secure one end of the sewing material with a timber hitch (see Chapter 2, Knots and Lashings) to the batten, thread the other end through the eye of the needle and sew the material in the ordinary manner to the batten.

To avoid holes where the sewing may tend to bunch the thatching together, pass the needle through the thatch at an acute angle. Then push the thatch over the crossing of the stitches.

STICK THATCH With the stick thatch, ties about 60 cm apart are fastened onto the thatching batten. The thatching stick is tied at one end, the material placed under it and when the tie, fixed on the batten is reached, the thatching stick is tied down thus binding the material together. This method of securing thatching is useful when long lengths of material for sewing are not available.

As with sewn thatching, the general principles of overlapping the layers to cover the thatching stick (rather than the thatching thread) are followed. This will ensure a rainproof roof. However, this is generally not as tight as sewn thatching.

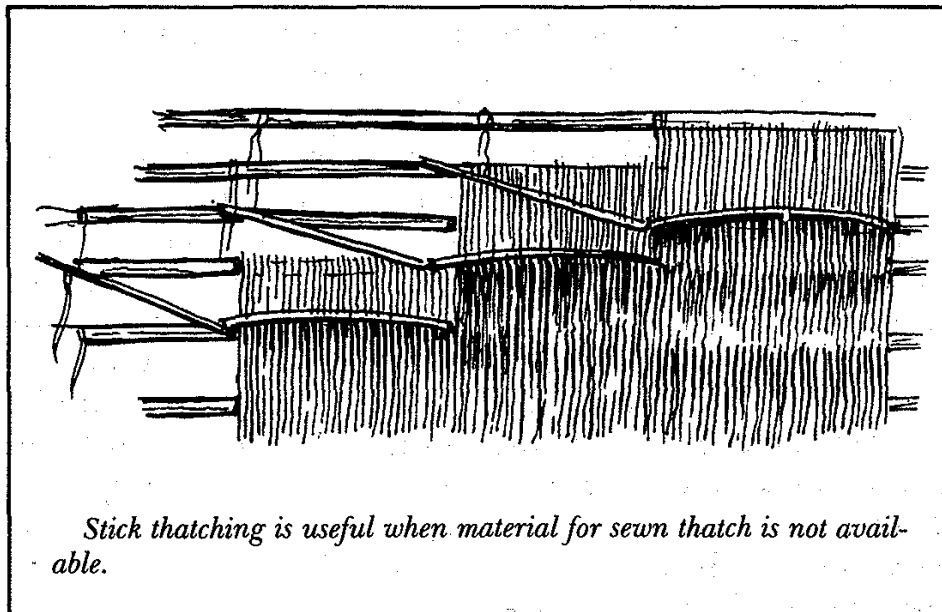

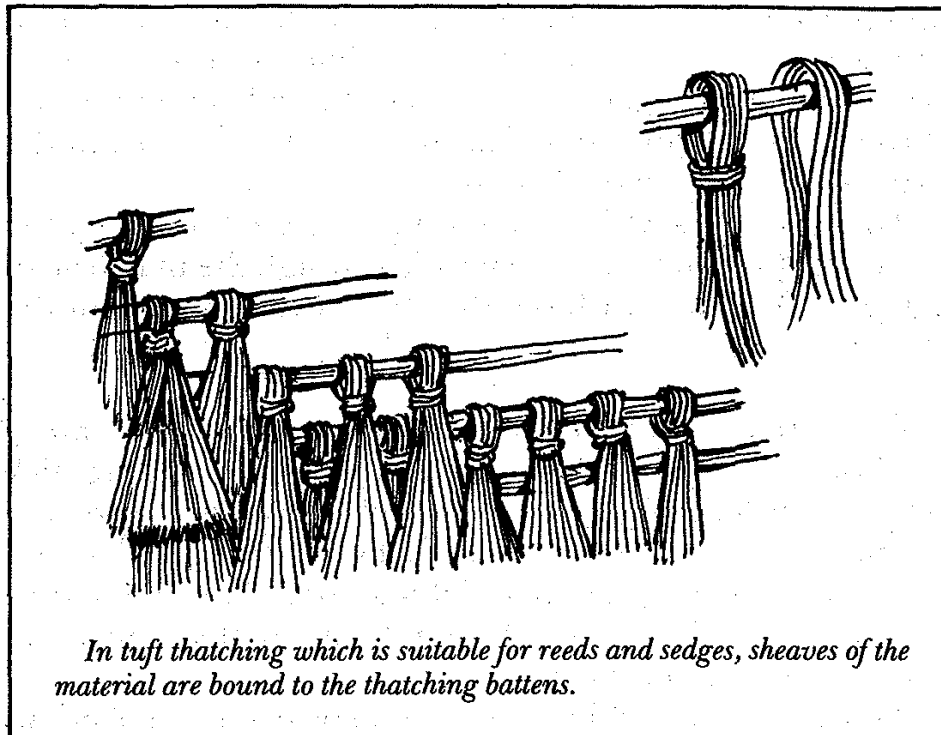

TUFT THATCHING This is an excellent method if the material is fairly long — between 60-70 cm and 1 metre — and pliable. It is very suitable for reeds and sedges. The material is gathered into small sheaves about 3 cm or so thick. The butt end is bent over the thatching batten. A few strands are then twisted around the sheaf a few times and pushed through the bunched up material to hold the end secure.

The tuft is then slipped along the batten and the procedure is continued until the batten is completed.

This thatch makes a very neat job from the inside. It is secure in all weather and requires no tying material. If sedges or sharp sword grasses are being used, protect your hands with a pair of socks to avoid cuts if gloves are not available.

It is important that the long, free ends of each tuft bundle overlap the two or three preceding rows. Do not push the joining or knot end of these tufts up too tightly together. There can be some space (say up to 2 cm) between the bent-over ends on the battens. This space will be covered by the free ends of the next row of tufts.

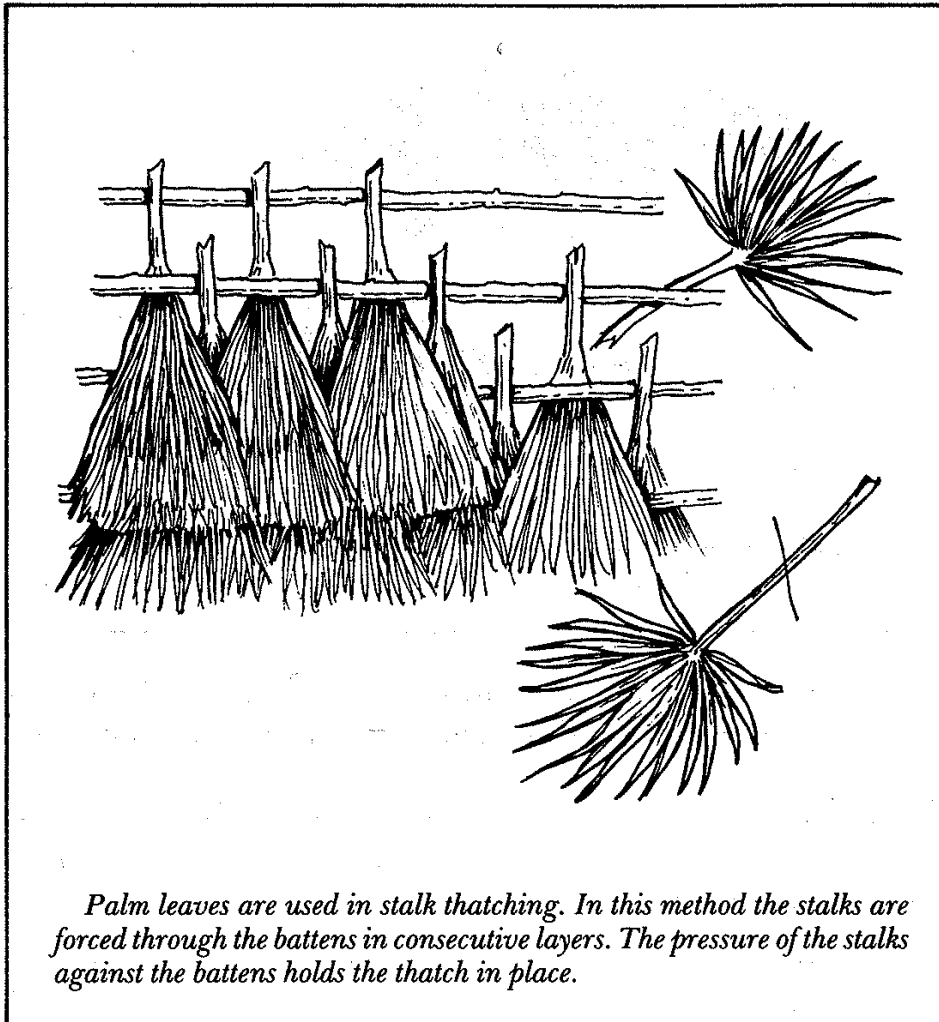

STALK THATCH Any type of palm leaf, complete with stalk, can be used for this type of thatching. It is both quick and efficient.

The stalks of the palms are woven through the thatch battens. The stalks are literally jammed between the battens and the natural pressure on them provides sufficient pressure to hold the thatching leaves in position.

SPLIT STALK THATCH This thatch is suitable for long pinnate leaves (such as those found on date palms). The centre rib of each frond is split lengthways. The split ribs are tied together and secured to the ridge poles of the hut in an over-

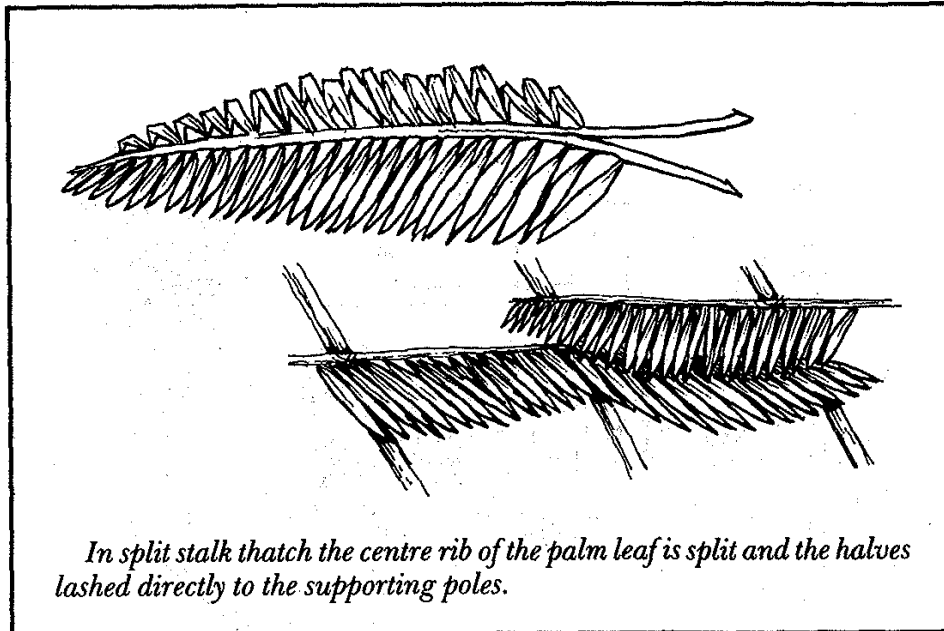

lapping fashion. This eliminates the need for thatching battens unless extra strength is required in the roof structure.

WOVEN THATCH This is an alternative to the split stalk thatch if a number of workers are available and the time factor is not important.

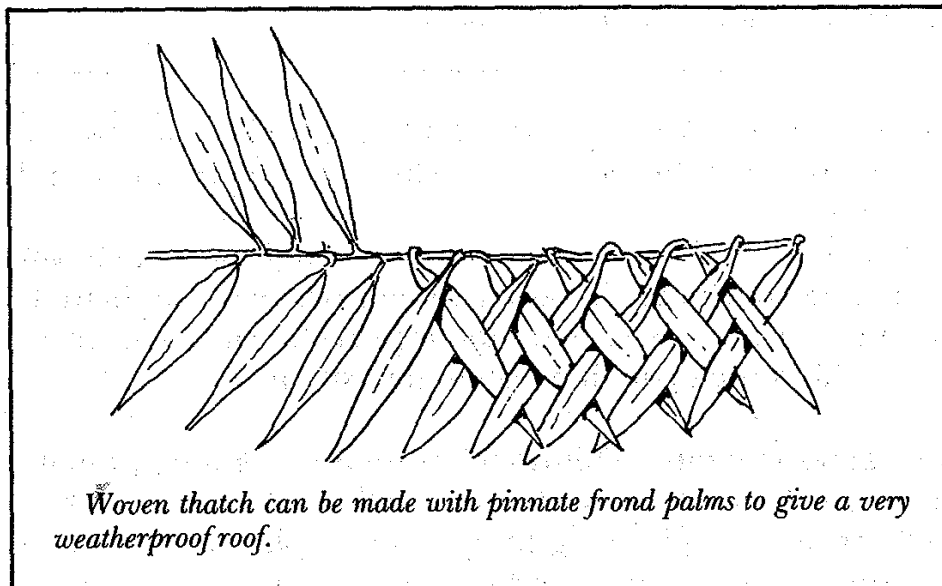

The pinnate fronds are laid flat on the ground and the leaves from one side are laid over one another and woven between the leaves opposite them. The stalk is then tied onto the framework of the hut, observing the same principle of overlapping used in all other thatching methods. Woven thatch is particularly suitable for wall construction and gives the hut a very neat finish.

SEWN BATTEN THATCH With long, broad-leaved materials, the sewn batten method can be used to give good results.

The leaves are bent over battens on the ground and a thin sliver of split cane or other suitable material used to pin the two sections together. The sticks are then tied to the framework of the hut as in split-stalk thatching.

If green material is used, make sure before starting the job that it does not curl as it dries out by testing it in strong sun for half a day.

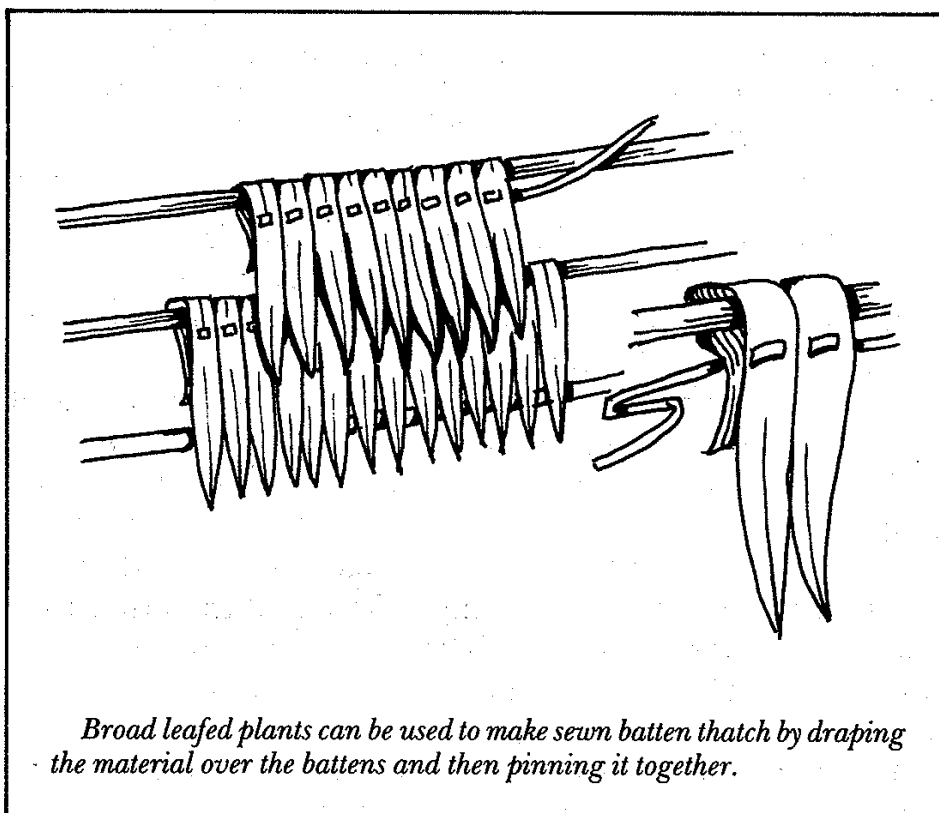

RIDGE THATCHING In thatching the ridge of any hut it is essential to cover or cap the topmost row of stitching or fastenings. If this is not done the roof will leak along the ridgeline.

This cap therefore must curl completely over the ridge pole or, better still, over a false ridge pole. Alternatively it may stand up from the ridge. If bound tightly, this will make an efficient watershed. For pyramidal and circular huts this is the best method.

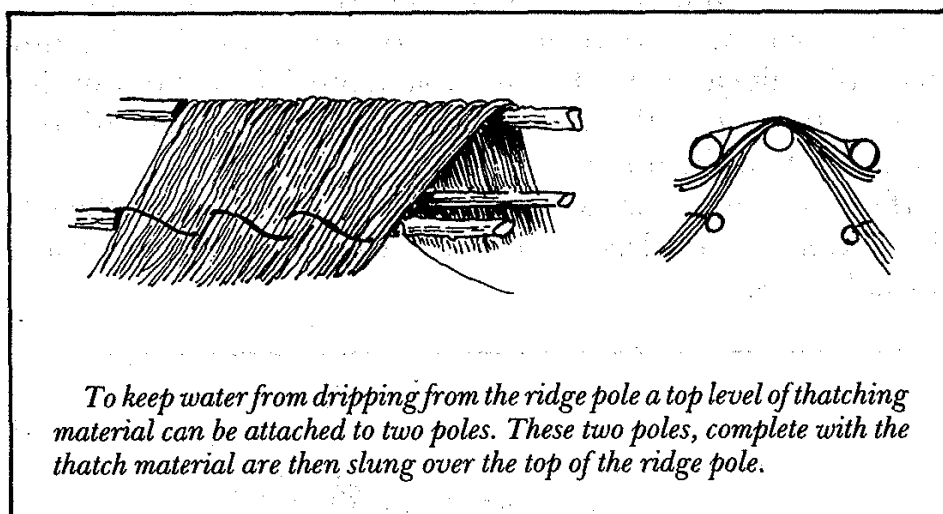

To keep water from dripping from the ridge pole a top level of thatching material can be attached to two poles. These two poles, complete with the thatch material are then slung over the top of the ridge pole.

SEWN RIDGE THATCH With very long material two heavy poles or straight branches may be slung over the ridge pole so that they lie on either side of it and hold the edges of the thatch down. (see illustration).

Another method is to tie two battens to the last line of thatching. The ends of the thatching material is then sewn to the battens so that it overhangs the stitching of the thatch proper.

An alternative method is to sew ridge material on to three poles, one of which acts as a false ridge and the other two, sewn to the ends of the material, hang down about 50 cm on either side. This can be made on the ground and then hoisted up to cover the ridge pole.

Another method is to make a simple crown of thatch without poles and cover the top layer of thatching.

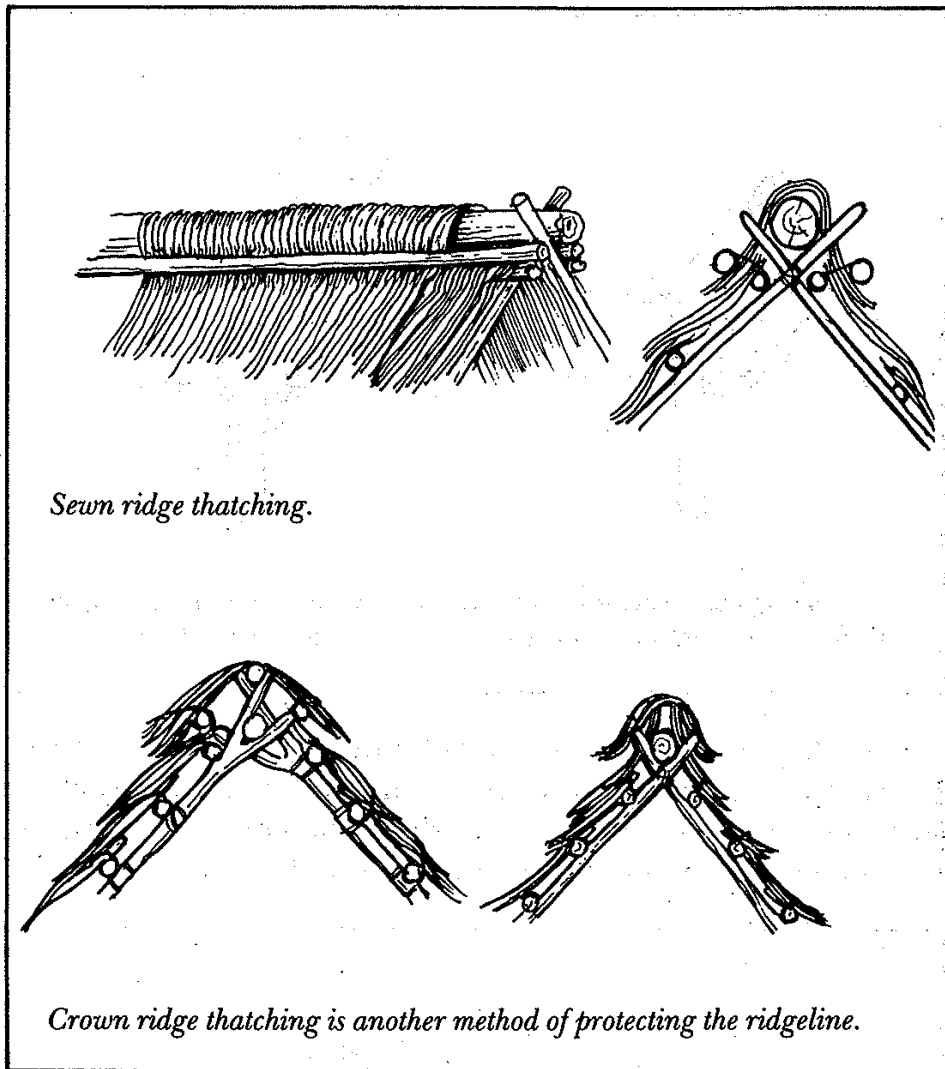

GUTTERING Under some conditions it may be necessary to put a 'valley' in the roof. This will require guttering. Efficient guttering can be made from wide sheets of bark inverted so that they lie with the hollow side in the roof valley.

In tropical areas an alternative (although a laborious one) is the use of hollowed out palm trunks. Very wide leaves of some of the palms can be laid so that they overlap one another.

Considerable care must be taken with this guttering if a watertight roof is the prime consideration.

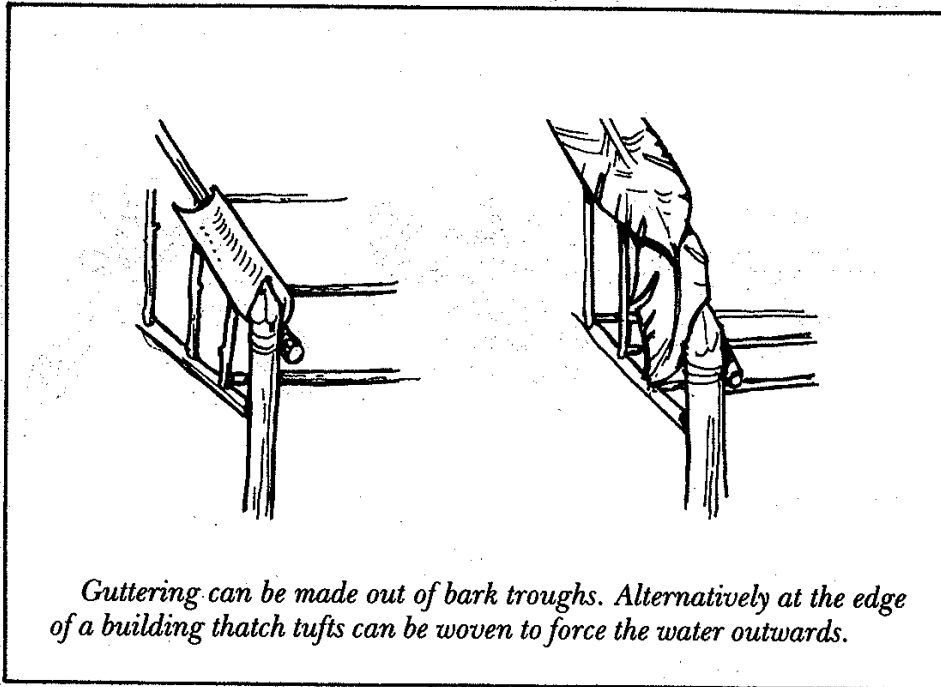

End drip gutters can be made from bark pieces or tufts of overlapping thatch. They are often needed on the weather side of the hut so that rainwater does not blow back from the last thatch overhang and through the walls.

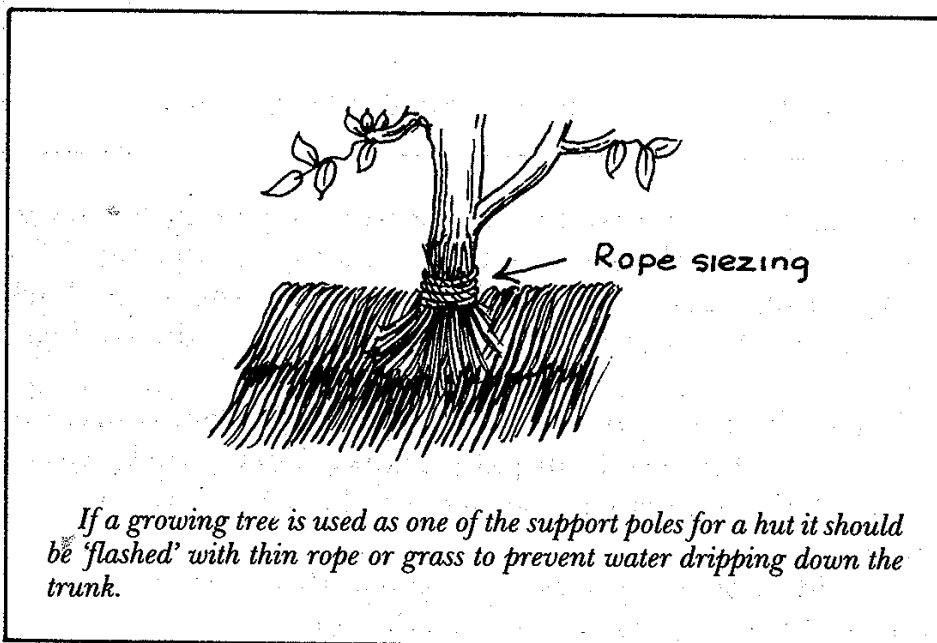

FLASHING If a living tree is being used as one of the supports for the hut's ridge pole, flashing may be required. This also applies if, for one reason or another, one or more of the structural support poles also project above the thatchline of the roof.

If flashing is needed spin up a length of thin rope from grass or other fibrous material (see Chapter 1, Ropes and Cords) and use it to bind extra thatching around the tree or the pole. Continue this binding several centimetres above the last of this extra thatching to ensure that the water runs off and down the roof, rather than down the tree trunk or pole and into the hut.

Rammed Earth Construction

Although fibre buildings will last for many years an even more permanent structure can be made out of rammed earth. This type of building can also be roofed with thatch.

Because of the large amount of time taken to construct a building out of rammed earth the method is not suitable for a campsite. It is however useful for one's own bush block, either as an initial shelter or secure storage shed.

Although the attitudes of many councils towards earth and pisé constructions has become more relaxed in recent years, a building of the type described here would not pass the test as a permanent house. There are now a number of specialised publications available on the building of sophisticated earth houses (plus a number of contractors who specialise in their construction). So if, strictly speaking, you are planning a more ambitious structure than a solid shed, these publications should be consulted. The local council building inspector should also be contacted as to the specific regulations for your particular area.

Earth buildings can either be constructed by making forms to contain the material or by ramming it in blocks, which look like large bricks, and laying these in courses.

The only material required for the walls of the building is earth. It should contain a proportion of clay, sand or other



Large stones set in clay are the usual foundations for a rammed earth building.

gritty particles. It should also be free from organic material such as shrub and tree roots.

FOUNDATIONS A rammed earth building must have a solid base. The foundations, or footings, can be made from large stones set in a clay base.

A trench 60 cm deep by 30 cm wide, lined all over with a 3 cm clay plaster is sufficient to bear the weight of the walls. Large stones are then set into this clay and the footing continued with more clay and more stones until a packed wall has been made that stands about 20 cm above ground level.

As long as the materials are at hand this is a no-cost operation. Clay is also an excellent medium into which to set the foundation stones because it is largely impervious to moisture once tramped in and the building will require no damp course.

Foundations can also be made with stones and concrete but in this case some sort of dampcourse will have to be constructed.

The purpose of extending the foundations 20 cm above ground level is to prevent water run-off from reaching the rammed earth section of the wall. Thus if the area is subject to occasional flash flooding the foundations may have to be built higher. Earth banks and drains can also be cut around the building to divert water flow if necessary. Wide, overhanging roof eaves also prevent damage to the earth wall on the weather side of the building.

Choose the site carefully. Watch the weather patterns and consider how the building can be best protected from the weather before erecting it.

SOIL QUALITIES Any heavy loamy soil is suitable for rammed earth construction. The soil must also have the right moisture content. To find out whether it is suitable, roll some earth into a ball about the size of a golf ball between the palms of the hands and drop it from a height of about 30 cm. If it breaks up on contact it is too dry and moisture must be added before ramming.

If it holds together after being dropped from this height apply a second test. Hold the same ball above your head and drop it again. It should shatter into small fragments. If it doesn't the material is too wet and should be allowed to dry out.

The soil should then be tested for its clay-silt-sand ratio. Although the ratios are fairly elastic not all soils are suitable for ramming. There should not be more than 70 per cent sand and not less than 30. By the same token there should not be more than 70 per cent clay and silt and not less than 30 per cent sand.

For proper earth bricks that will last many years the ideal proportions are 50 per cent clay material and 50 per cent sand. On any area of land soils can vary greatly. The intending builder should take samples from various parts of the block. It may also be necessary to combine soils from one or two locations to get the desired mix.

Soil qualities can be quite easily determined. Take a glass tube 10 cm long. Dry some of the test earth, crumble it to powder and fill the tube. Then empty it into a dish and wash thoroughly in slowly running water until all the clay and silt particles have been floated out over the rim. Dry out what remains in the bottom of the dish and place it back in the tube. This final level in the tube will give you the proportion of clay to sand.

Soil with too high a clay content will crack. But on the other hand if there is too much sand the block will crumble.

STRENGTHENING MATERIAL Although earth walls can be made with plain soil, quite often a binding agent is included to give it extra strength. Dried grass or straw is the most suitable binder. If the bricks are being made in individual moulds it should be cut in short lengths to fit the container. If using the wall framework method of construction any reasonable length will do, although the shorter it is the better it will mix with the clay-sand material.

Other suitable material includes small stones or river gravel, which may be contained in the soil when it is dug.

If mixing either straw or gravel, a number of test blocks should be made using varying quantities of the additives. They should then be allowed to thoroughly dry and season and then compared for general strength, cracking and crumbling. But remember to note down what quantities you added to what particular form. Otherwise the test will mean nothing.

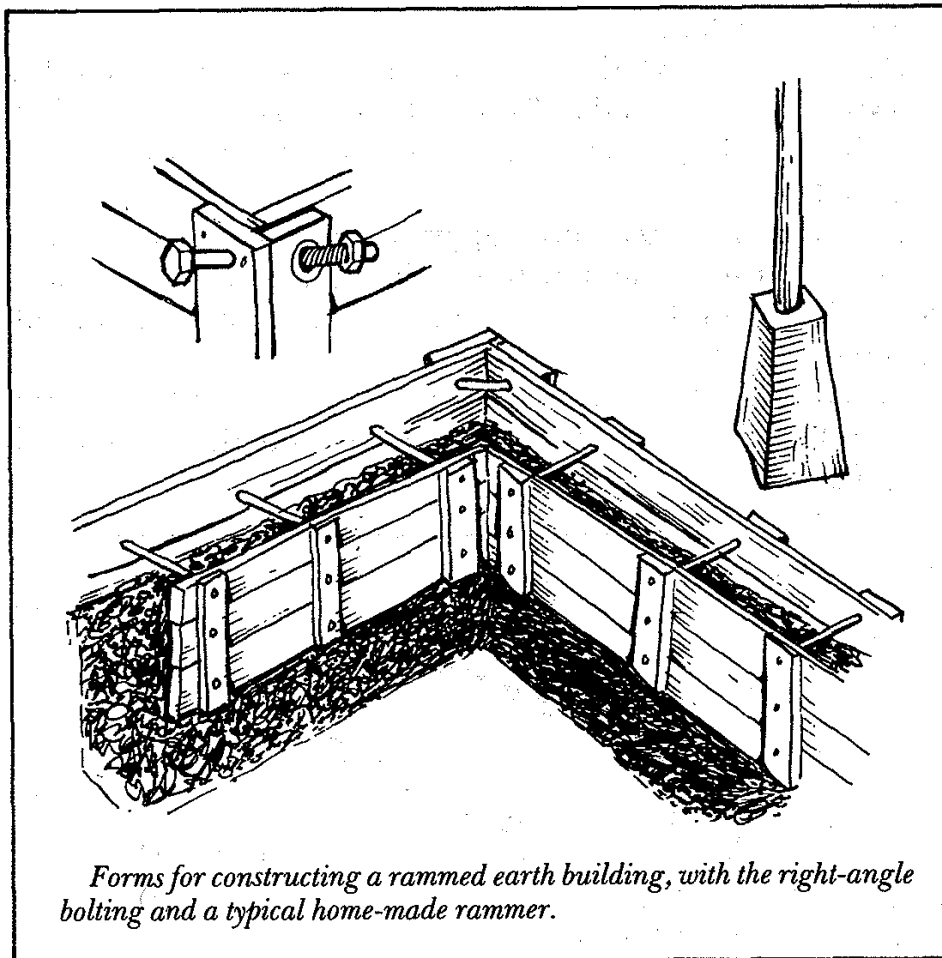

FORMS AND MOULDS Forms can be made from a series of boards which are bolted together to allow the rammed earth wall to be built directly onto the footings of the building.

Alternatively, moulds can be made and the earth rammed into them to make blocks. After drying, these blocks are laid in the manner of large bricks.

If forms are used the most convenient size for filling is about 1 metre high and about 2 metres in length. At the first level they are clamped onto the top of the footing by the use of bolts or, alternatively, held fast by poles driven into the earth and secured at the top.

When ramming shovel in about 10 cm of earth along the length of the form and ram it down until it 'rings'. This is quite a definite sound and is quite different to the soft 'thud', of the first strokes.

Ramming is hard, tiring work. The person operating the ram should be relieved at frequent intervals. When the first layer is 'ringing' throughout its length the process is repeated.

It should be noted that separate right-angle forms are needed for the corners of the building and particular care should be taken that the earth on these sections is rammed extremely hard.

Each level of the wall should be allowed to cure for several days before the moulds are removed and the next level attempted.

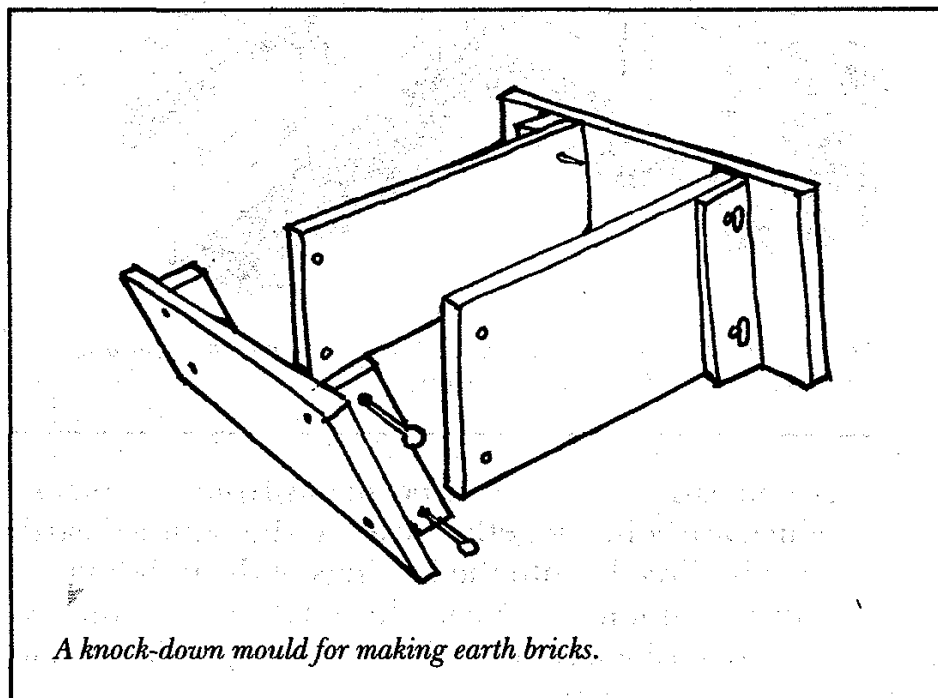

Door frames and windows should be allowed for. The timber frames for both should be incorporated in the building as the earth is rammed into position.

Rammers, usually with a flat, round, hardwood head, should weigh between 2 and 4 kg, with a long handle for easy grasping.

For a wall 2.5 to 3 metres in height, the thickness of the earth itself needs to be between 25 and 30 cm. For walls higher than 3 metres, the thickness should be around 40 cm.

If moulds are used they should be designed so that once a 'brick' has been rammed in them they can be knocked down quickly and easily to proceed with the next brick. The bricks are allowed to cure without support. It should be stressed that the making of earth walls or bricks is a dry weather activity. If it rains tarpaulins should be used to protect the bricks until they are properly cured.

Once the walls have been erected and the house or shed has been roofed, extra protection for the outside walls can be provided against heavy rain (apart from the above-mentioned overhanging eaves) by several methods. These include whitewash, lime-wash, a cow dung-mud render mix, wallpaper size, a latex based paint, bituminous paint or a cement render made of one portion of cement to two of sand applied in an extremely liquid form.

Rammed earth buildings, properly constructed, have been known to stand for 100 years or more.

Log Cabins

Where timber is plentiful and white ants do not present a problem, a log cabin can be built for a permanent shed or house.

Construction is simple. The logs should be cut to within a few centimetres of the required length. Lay the bed logs, which should be the heaviest, in their required position. Make sure that they are square. Where the end logs lie across the back and front ones, halve or 'scarf' the sites. ('Scarfig' cuts the logs into one another.)

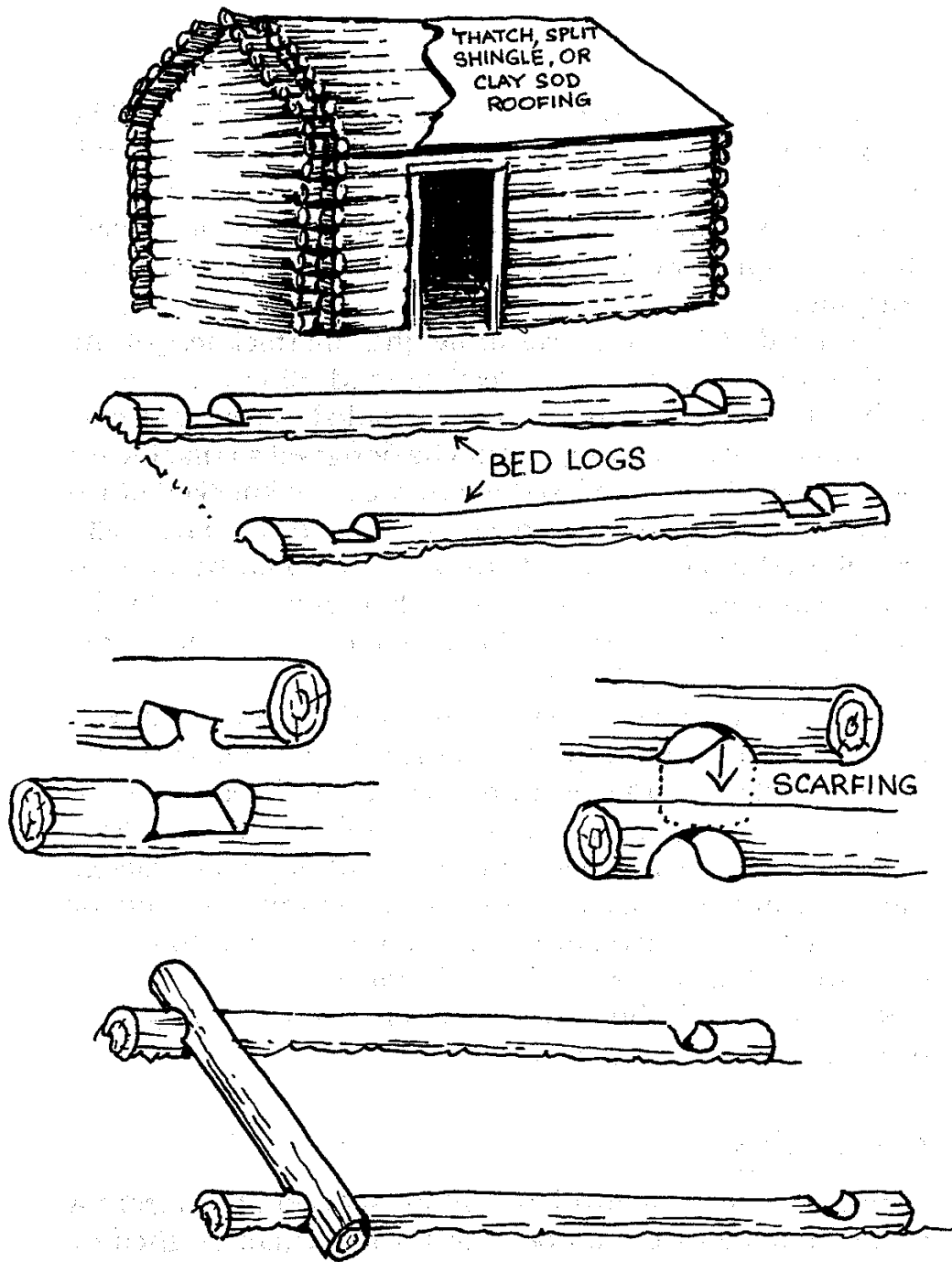

A completed log cabin with the methods of constructing it. Once the roof has been topped with logs it can be overlaid with thatch, clay sods or shingles. In Australia early cabins were often roofed with bark sheets weighed down by holding poles and large stones.

The remainder of the construction follows exactly the same pattern. The logs are 'carved' into one another.

In scarfing logs for building, the flat surface of the bottom log always 'falls' outwards so that when any rainwater blows in it will not find a place for easy lodgment but will drain away because of the natural slope. Chinks between the logs should be filled with clay on the inside of the building.

Useful Hints

MATERIALS FOR LASHINGS Although in building larger structures, manufactured items, such as rope, twine, special tools and perhaps even nails and some dressed timber, will be used, in some circumstances these are not readily available.

Therefore improvisation is necessary. For lashings, sewing and tying any ground or tree vine which has length, strength and pliability will serve. Length is visible and easily assessed. But tests for strength and pliability should be made. The test for strength is simply to exert a steady, straight pull on the material. If it snaps easily it is useless.

The test for pliability is to tie a thumb knot in the vine and gently pull it tight. If it snaps or cuts in upon itself it lacks pliability and should be discarded.

In addition to the vines, the outer skin of long leaves of most palms may be used for ties. To harvest these nick the hard outer shell with a cut 5 mm wide and about 1 mm or less deep (just a nick downwards in other words). Then gently split the two surfaces apart bending the thick part away from the thin.

This principle of bending away to prevent running off or splitting out applies to all canes, palms, vines, bamboos and barks.

The inner bark of many shrubs and trees, alive or dead, also makes excellent lashing material. Strip down to the required thickness but watch for weak spots where it is likely to fray away.

SPECIAL KNOTS Many of the sedges have length and strength

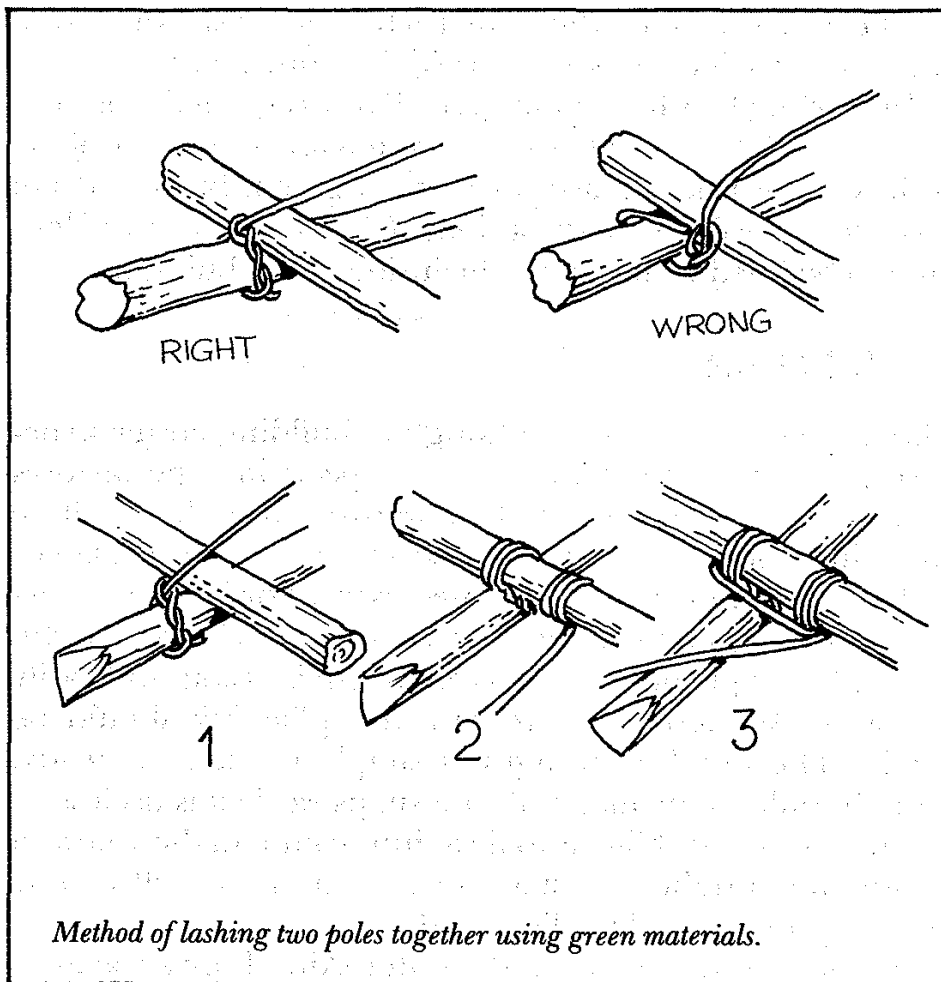

and may be used for lashing and sewing work. Nearly all the bullrushes can serve as lashings.

These green materials require special knots. The customary start of a square lashing is with a clove hitch (see Chapter 2, Knots and Lashings), but such a hitch on green bush material is useless. The natural springiness in it will cause the start of the knot to open. Always start a lashing with a timber hitch. Always see that the free end passes straight through the eye and does not come back against it. If it does it will probably cut through itself.

After starting your lashing with a timber hitch (Fig.1), make three complete turns around the two poles and work them together as you tighten the lashing at each turn (Fig.

2). The frapping turns then follow (Fig.3). These frapping turns close the lashing in and tighten the whole. Finish off by passing the free end of the material through an opening in the lashing and finish with a couple of half hitches pulled tight.

JOINING GREEN MATERIALS The best knot for joining green materials is either the sheet bend or the reef knot. Both are illustrated in Chapter 2, Knots and Lashings.

4 Campcraft

A comfortable temporary or permanent camp is easy to set up and maintain with a little common sense and know-how, plus a few basic tools.

As mentioned in Chapter 3, Huts and Thatching, modern lightweight materials plus structures that telescope into almost nothing have meant that most people, given a vehicle, can take the city into the bush without having to improvise. In some cases this has led to what might be gently termed over-equipping oneself for the rigours of outdoor life. One recently published list of 'essentials' included 95 items (including toothpicks of all things) without which it was impossible to survive. This list did not include food.

While there is no excuse for destroying bushland, given a knife, an axe or machete, and dead timber and other bush materials, everything one needs for a bed, table, seats and chairs, cooking and lighting can usually be found quite close to the chosen campsite.

There is no need for a camper to be uncomfortable if he or she exercises a little ingenuity. A properly made camp bed can be as restful as an inner-spring mattress. And no food has more flavour than when cooked out of doors.

Once learned, these skills can also be of great use in emergency situations.

Setting up Camp

PEGS AND STAKES When setting up a camp a constant supply of small pegs and stakes is needed for many purposes. They must be cut properly or they will not drive cleanly into the

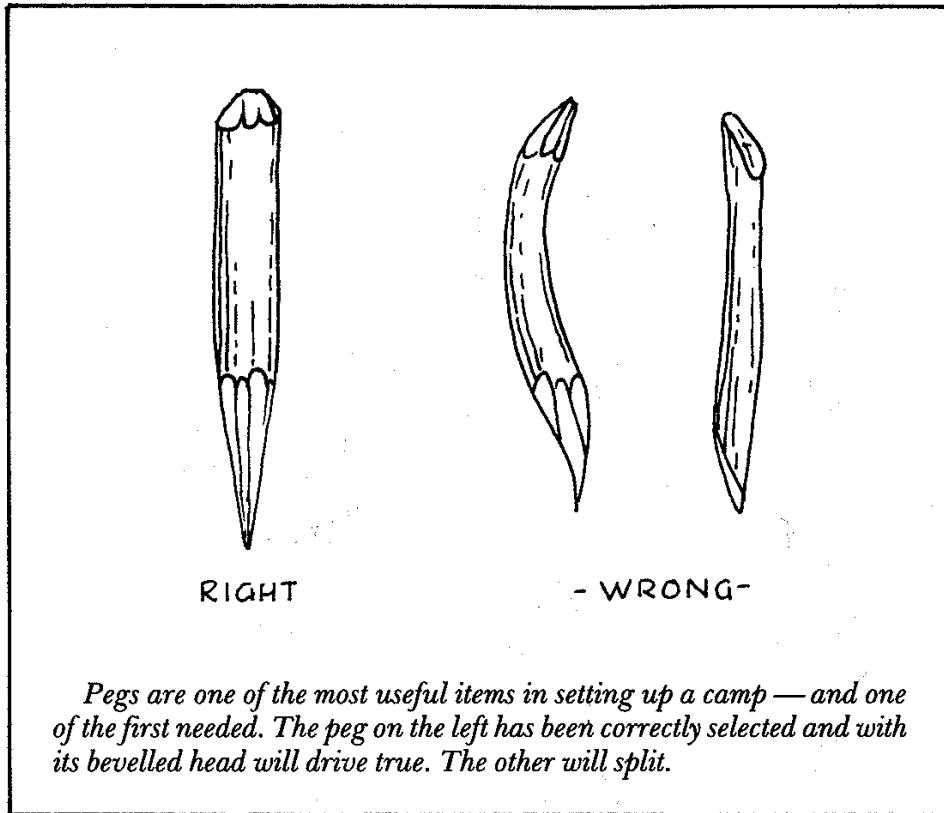

ground and, instead, will split or twist. The wood selected should be as straight as possible. It should then be cut into the required lengths and the head should be bevelled. The 'toe' should be sharpened all round, in the same manner as a lead pencil is sharpened. If it is simply cut diagonally it will not drive cleanly.

FORKS The best sort of fork is one with a perfectly straight drive from the head to the toe and with the fork itself coming off at an angle. Like a stake the head should be bevelled and the toe sharpened all round.

Hooks Hooks require less care in their selection, unless they are to be driven into the ground. If they are to be, then once again, they must be straight. In choosing material for any of these items make sure before using it that the wood, though dead, does not have a rotten core.

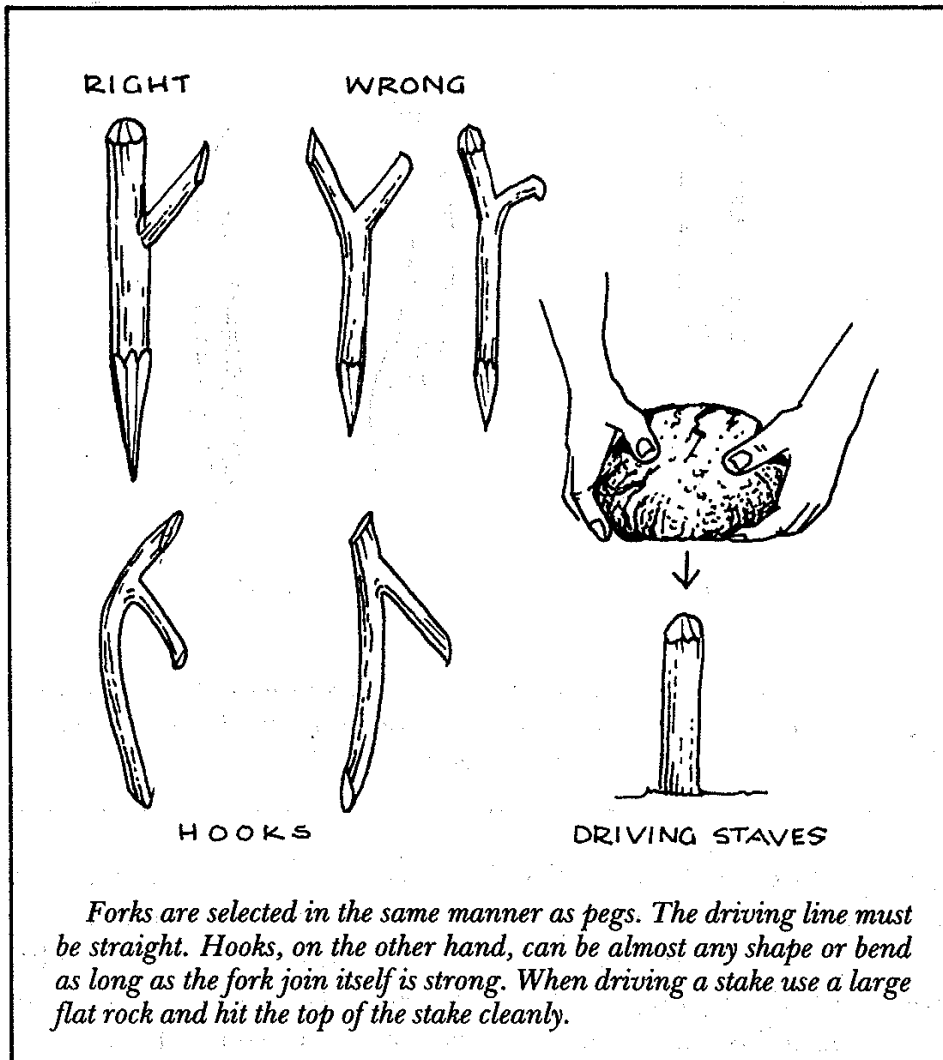

DRIVING STAKES AND FORKS Stakes and forks can be driven into the ground by using either the back of an axe as a sledgehammer or, if this implement is not available, a large stone held by both hands. The stone should have a flat driving surface. Also, a club can be fashioned with a heavy knife.

CAMP KITCHENS AND COOKING To make life comfortable for the cook, the camp kitchen should be sited so that the prevailing winds of the area do not blow into his or her face.

If setting up camp in an unknown area it is not always possible to find out what the prevailing wind is. But certain gen-

eral conditions prevail the world over and knowing them helps.

On the coast, because, during the daytime hours the sea is cooler than the land, about mid-afternoon a sea breeze flows towards the land mass. As the land cools in the evening the flow is reversed and the wind blows from the land to the sea.

In hilly inland areas the morning breeze, known as an anabatic wind, blows up the valley as the sun heats the eastern sides of the hills. In the late afternoon and evening the breeze blows down the hillslopes to the valley floor as the sides cool. This is known as a katabatic wind.

With this knowledge the fire can be set sideways to these generally prevailing wind patterns, so avoiding smoky cooking. In the valley situation the fire should be faced neither up valley nor down valley, but sideways, allowing the smoke to blow past the cook at any time of day.

The camp kitchen area should always be sited on a slight rise if possible so that in the event of a heavy downpour it will not be flooded. In a badly drained area it should be built up about 10 cm above ground level, by piling up earth and stamping it down to a flat surface or collecting a set of reasonably even rocks for a rough pavement.

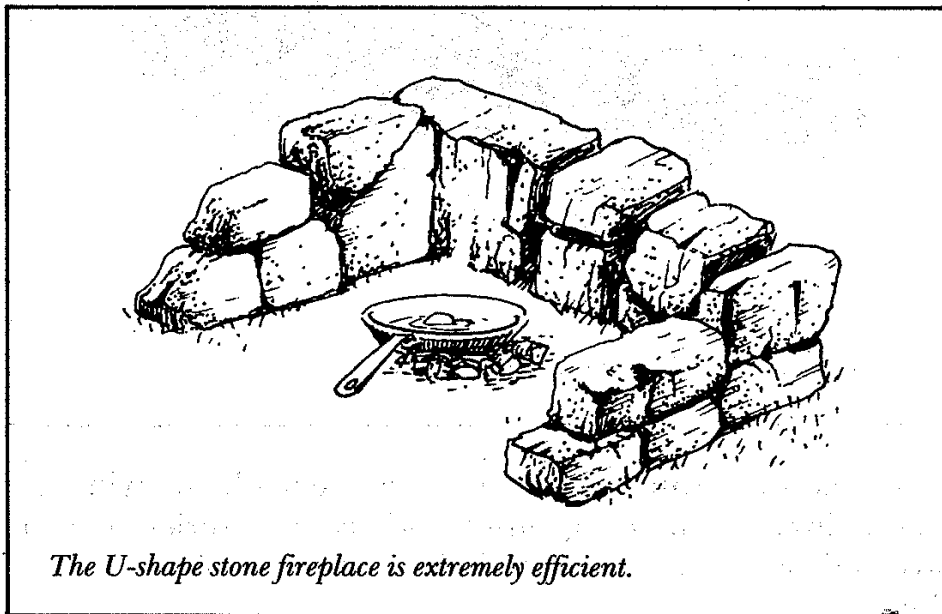

FIREPLACES There are many different types of safe and efficient camp fireplaces. Their construction depends on the materials at hand.

If large stones are available build a wall to enclose the fire on three sides. Almost any height will do, depending on the size of the stones, but a wall of around 25 cm provides a good-sized coal and ash bed in which to cook potatoes or to place a camp oven.

As a general rule do not take rocks from a stream or river bed to make a stone fireplace. These are often highly unstable and will explode as the fire gets hot.

A second method is to dig a trench and stack the soil or oblong turfs to each side. This method is widely used in out-back areas where the soil is heavy and conditions are usually dry. It is virtually windproof. It works best where the soil is mostly heavy clay and the ground is absolutely dry. It is useless in damp or boggy areas.

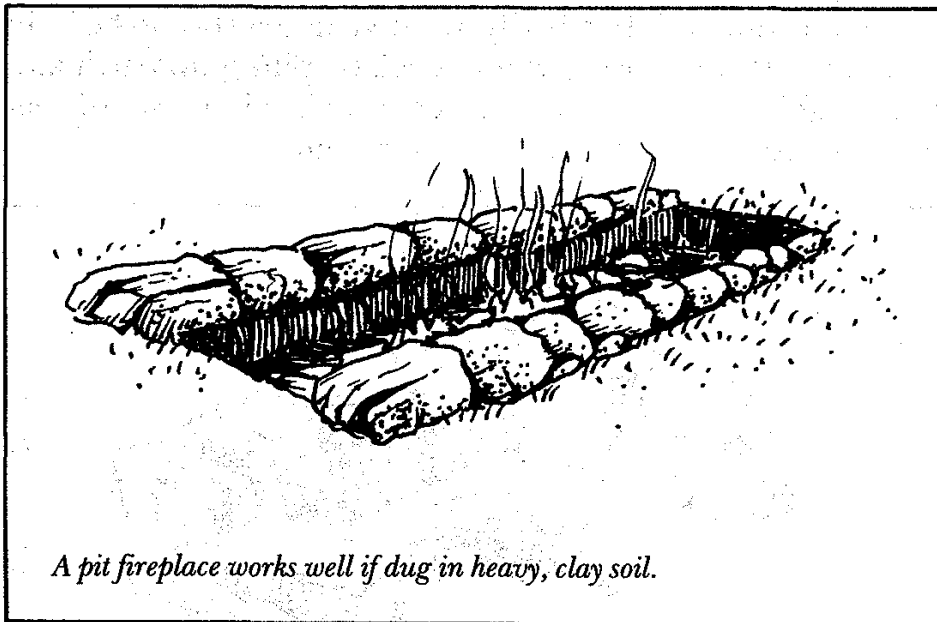

A pit fireplace works well if dug in heavy, clay soil.

Simple 'one-stop' camping fires can be made by laying the wood directly on the ground and using a series of constructed props and stakes to hold cooking implements (see illustrations).

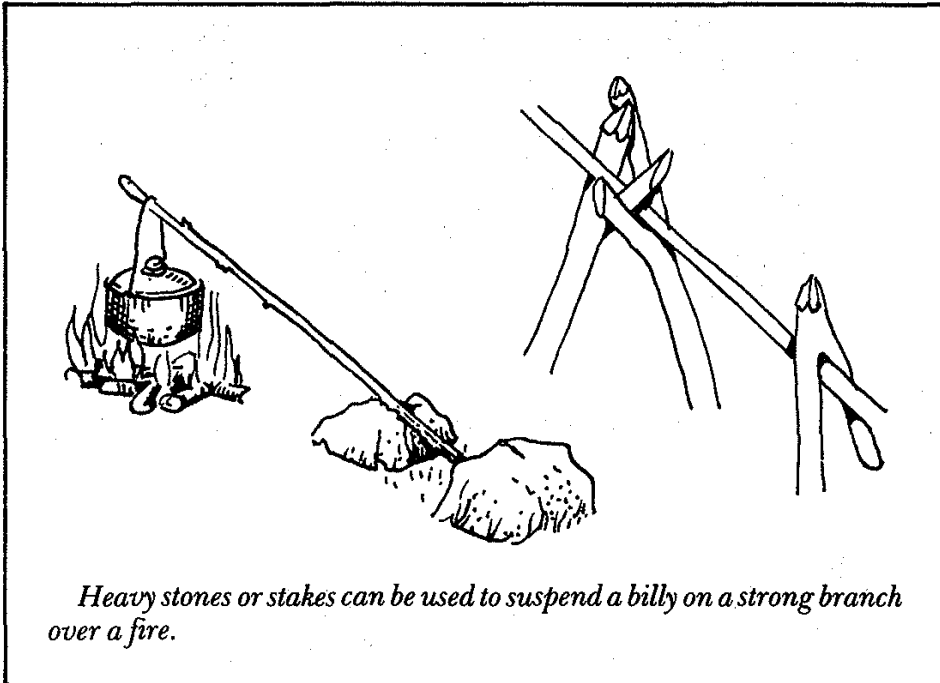

Heavy stones or stakes can be used to suspend a billy on a strong branch over a fire.

The stake and pole method of suspending cooking pots over fires can be as uncomplicated or complicated as one wishes. For a single night camp it is a waste of time to be over-elaborate (a billy will after all boil reasonably quickly if placed at the edge of the fireplace itself or directly on top of a bed of coals).

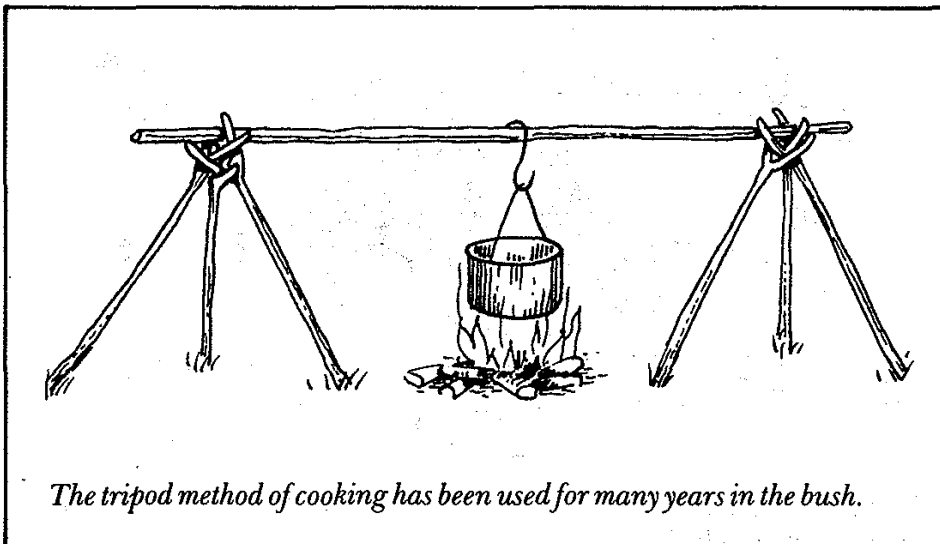

The tripod method of cooking has been used for many years in the bush.

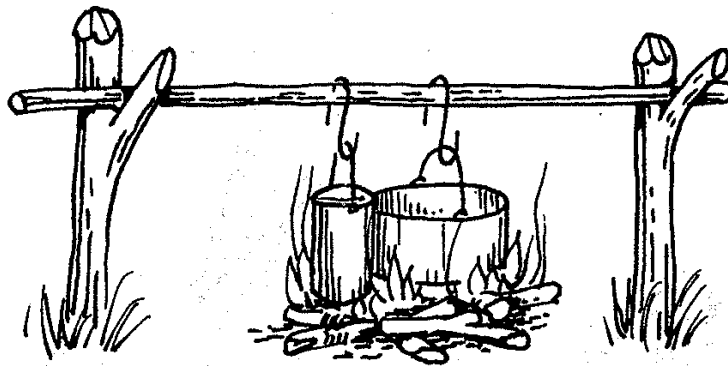

Forked stakes are a variant on the tripod method of suspending vessels over a fire.

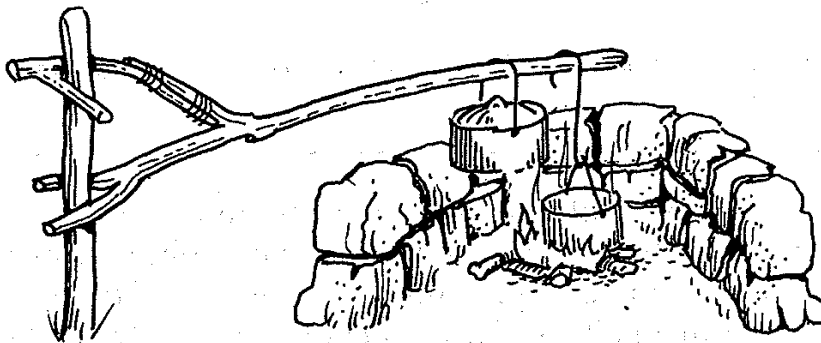

A swinging gantry can be easily made to move vessels on and off a fire as necessary.

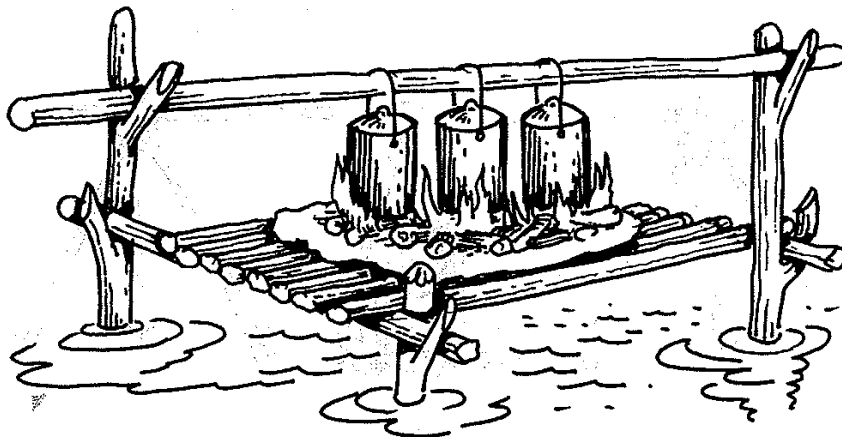

Cooking can be done even in flooded conditions if the fire is built on a mud-plastered platform.

The best method of all in a permanent camp calls for a single, straight stake to be driven into the ground at one side of the fireplace. From this single stake a swinging gantry is hung. The height of the gantry on the upright stake can be adjusted to any height above the fire.

It will swing free of the flames and the billy can be taken off without the risk of burnt fingers.

In flooded country, or in marsh or swampland, it may be impossible to find a dry area on which to light any sort of fire. One way to overcome this is to build a raised platform with its floor above the water level. The sticks which make the base of the platform are covered with a thick layer of mud. This should be allowed to dry as much as possible. Then a fire can be lit on this base and the meal cooked.

In the absence of stones and where green wood is of no value — such as sucker growth — it can be used to make a reflector fireplace. The reflector, made by driving four stakes into the ground and stacking cut lengths of green wood up it to a height of about 50 cm, should be on the windward side of the fire. The wind, passing over the top of the reflector, draws the flames upwards and so increases the strength of the fire.

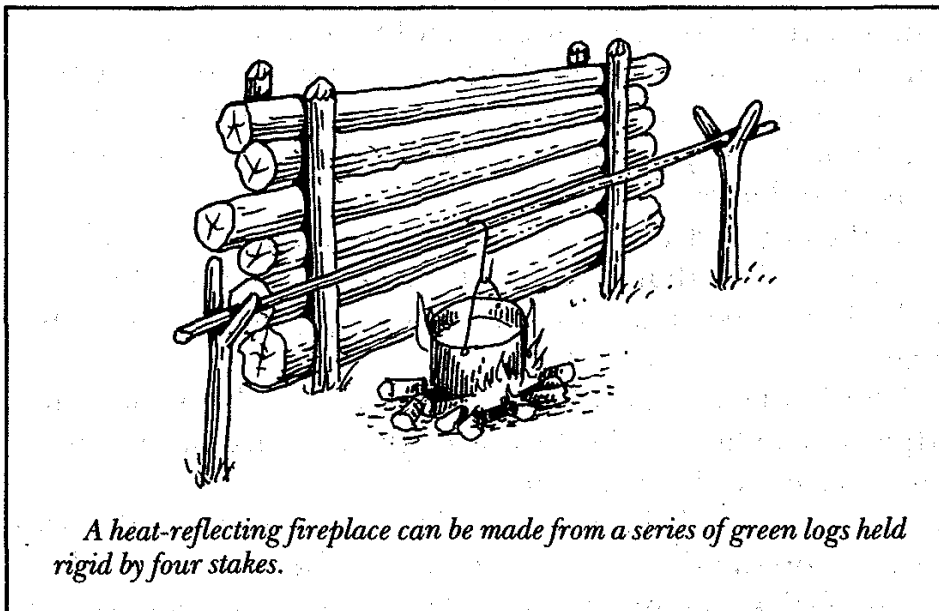

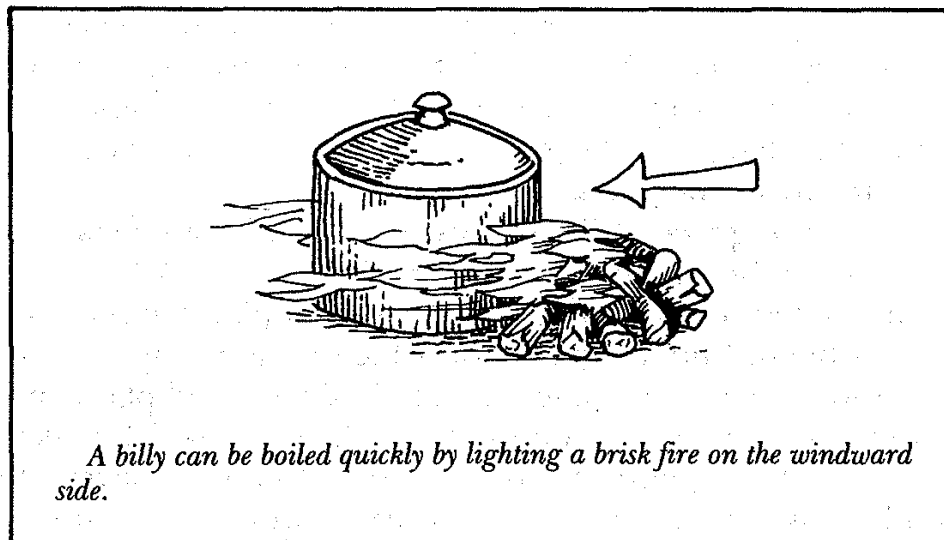

If you want to boil a billy quickly in an open space in a very high wind, the flames will be blown away if the billy is suspended. Bushmen have a trick that is worth remembering under such circumstances. Place the billy on the ground and build the fire to windward and around two sides of the container. The wind will blow the flames around the sides of the billy and it will boil quickly.

BILLY HOOKS AND FIRE TONGS All methods of suspending containers over a fire are made easier by the use of billy hooks. These can be made by cutting a few hooked sticks 1 cm or less in diameter in varying lengths — depending on the height of the suspension pole and the depth of the container above the flames.

At the end farthest from the hook a single deep nick is cut into the stick so that it will hold the handle of the billy. This nick should be made on the side opposite the hook for strength.

Billy hooks can also be made of wire and can be made adjustable in height. As these are light they are easily stowed for carrying to the campsite.

Apart from billy hooks, camp kitchen equipment that can be made on the site include fire tongs. These can be made of a pair of sticks bound together at one end with bush twine or

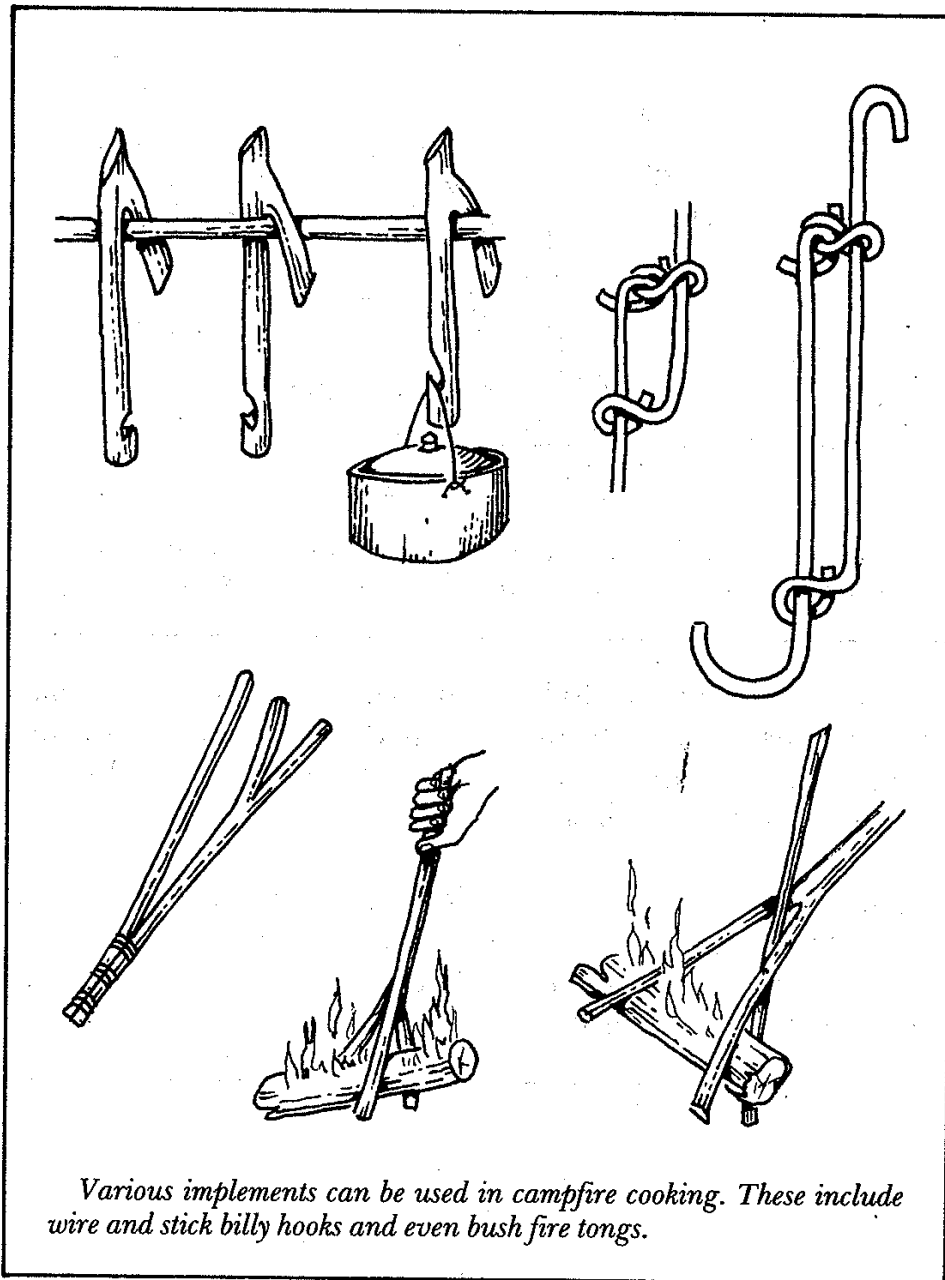

ordinary string or a forked stick with a single stick through the fork (see illustration).

WOODSHED If a permanent camp is being made, a woodshed is a very useful item to protect both large logs and kindling from rain.

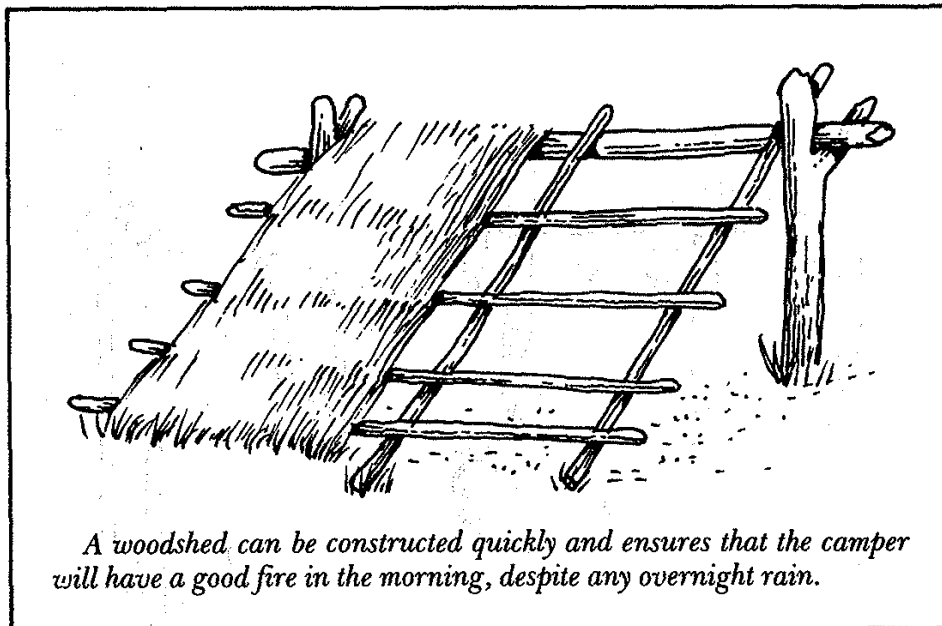

The woodshed should be to the windward of the fireplace so that sparks will not be blown onto dry bark or other tinder. It can be of any dimensions and should be thatched with reasonably durable material.

FIREWOOD AND FIRE IN RAIN Wood picked up from damp ground after heavy rain is useless for starting a fire. Instead, pull dead branches off trees. These will be much drier and will burn relatively easily.

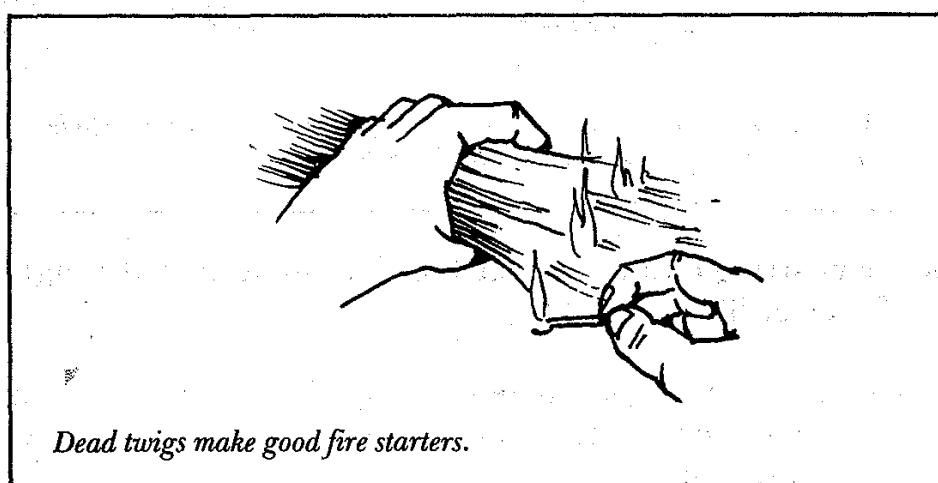

After rain a fire can be started relatively easily with small material, plus the dead tree branches, by picking a large handful of thin, dead twigs from bushes. These should be made into a bundle and a match applied to the frayed ends. Keep on twisting and turning this bundle until it is well alight and then place under a pile of small twigs. Larger pieces can be added later.



Fuzz sticks are a sure way to start a fire in wet weather.

However, if the twigs are too wet, 'fuzz' sticks can be made. Select several pieces of dead wood on a shrub or tree and break them into lengths of about 25 cm. They should be about 1-2 cm thick. Cut away any damp outer wood and trim the dry wood down in 'feathers'. Three or four of these 'fuzz' sticks can start a fire.

For real wet-weather emergencies at the start of a trip a bandage (made of cotton) can be soaked in kerosene and

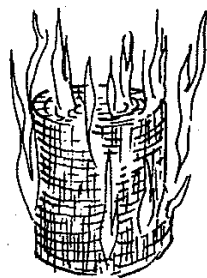

A kerosene soaked bandage kept in a tin will start a fire quickly.

packed into a round, leakproof container. Once alight this bandage will start a fire under almost any conditions.

When cutting branches, whether wet or dry, for use in a fire, deep cuts should be made opposite one another on either side. Then hold the branch by one end and bring it down sharply on a convenient rock or log with the cut area at the point of impact. One sharp blow will generally break the wood, saving the trouble of cutting it completely through.

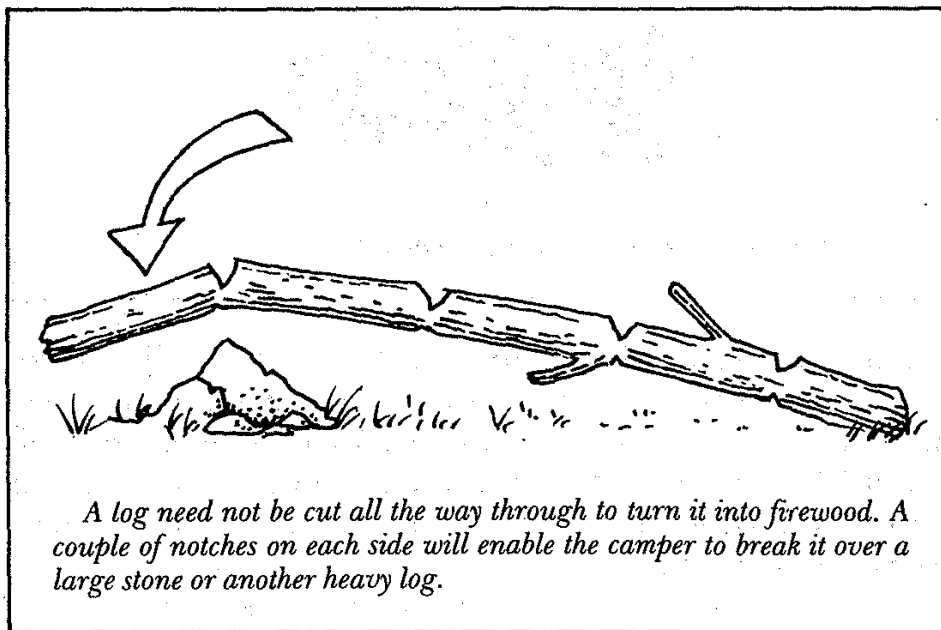

BOILING AND BAKING WITHOUT UTENSILS In an emergency the camper may want to boil water to either sterilise it to some degree or to cook food, but have no water-holding vessel available.

A shallow hole can be scraped in the ground and lined with a groundsheet, newspaper (if it is available), bark, or any material in fact that will hold liquid.

Build a hot fire and heat a number of small stones in it. Fill the lined hole with water and when the stones are almost red hot lift them from the fire one at a time with a pair of improvised bush tongs and put them gently into the water-filled hole.

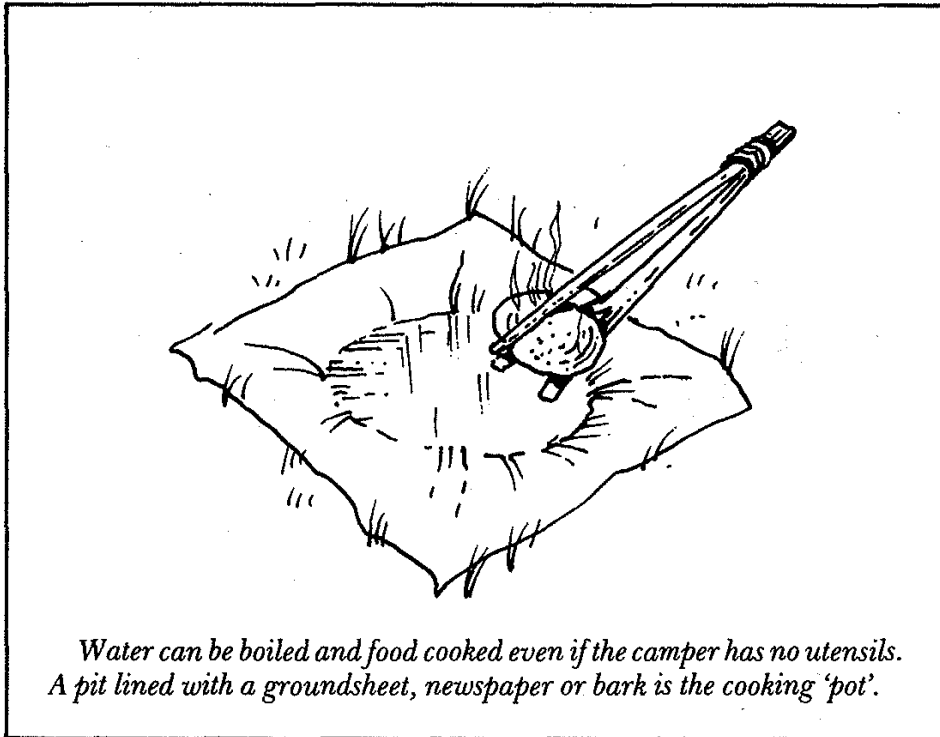

If the operation is carried out carefully the stones will not burn the cloth, paper or bark and a litre or slightly more of water can be brought to the boil in a few minutes.

The water can be maintained at the boil by placing new stones in the water as the ones that have lost their heat are removed.

BARK DISH OR COOLAMON An improvised boiling container can be made out of bark. A flat piece of bark of a species that does not split easily is stripped from a living tree. Take off a small piece at first and test it by softening it in your hands and folding it.

If it does not crack, fold it into the shape (more or less) of a shoe box, much as you would with wrapping paper. Attach two short sticks to the ends of the container and tie them with twine or fibrous bush material.

The bark of Australia's native *Ficus* (fig) species is especially suitable for making these containers, known to the Aborigines for centuries as coolamons.

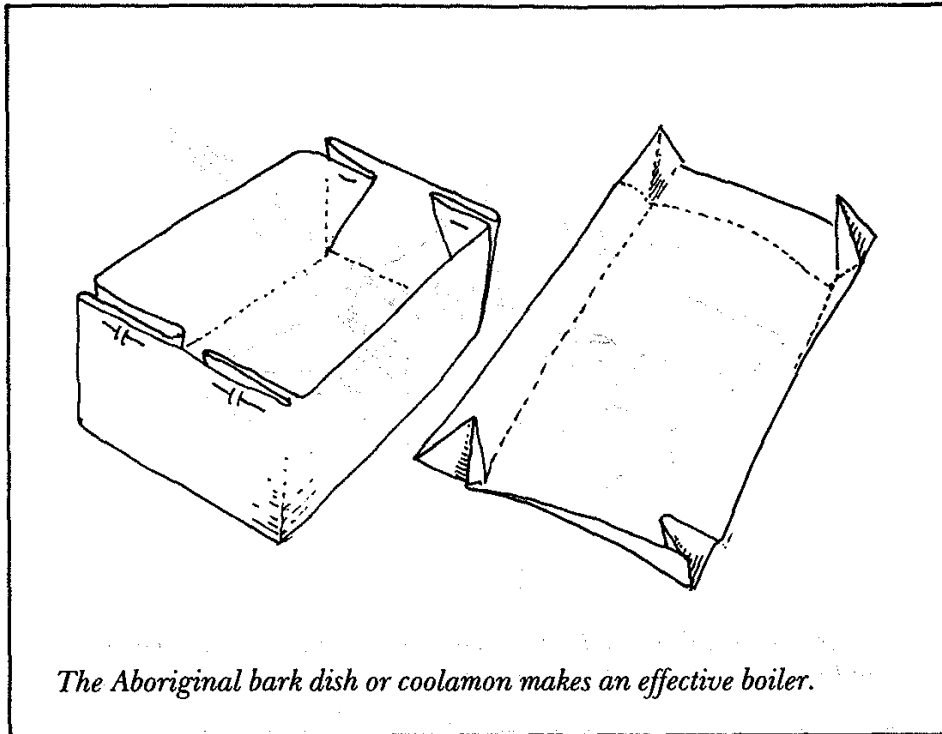

Other highly suitable container barks come from the paperbark subspecies of eucalypts. They are pliable and can be stripped off in large sheets.

HOT STONE BAKING Meat can be grilled on hot stones by placing a large flat rock in a fire until it is almost red hot, whisking the ash off it and then raking it out of the fire — or at least to one side. The meat can then be placed directly on the surface of the stone. A forked stick makes the perfect barbecue tool.

Stone ovens are easily constructed by placing a large rock as a lid over an open stone fireplace. Light a large fire in the cavity and when the rocks are extremely hot, draw the fire out and place the food to be cooked in the heated cavity.

Leave the coals and ashes raked out of the fireplace in front of the opening to provide some additional frontal heat to prevent the temperature dropping too rapidly.

An old drum or a large tin, if available, can also be made into a very effective oven. The drum can be either set flat on

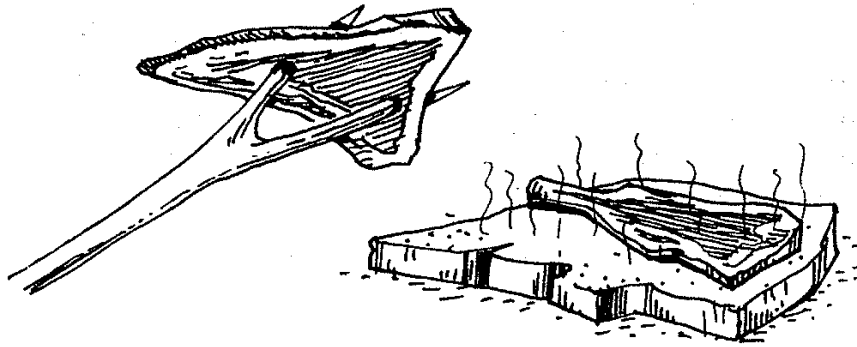

Meat can be cooked on stakes or on a red hot flat stone.

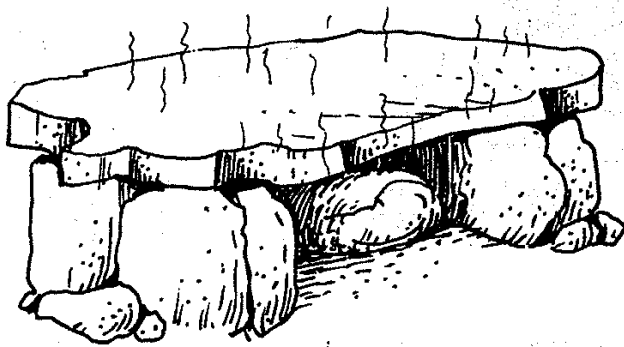

A stone oven can be constructed out of rocks.

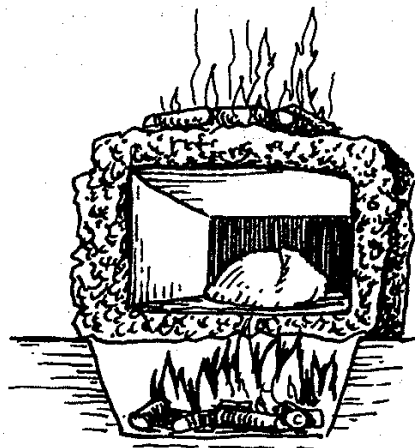

A large tin, banked with clay, makes an effective rough oven.

the ground and coated with clay or earth and the fire lighted inside it, or it can be placed over a trench and the fire kept burning underneath it. The soil or clay acts as insulation. If using the 'flat on the ground method', build the fire in the drum, rake out the ashes and coals when it has burned down and heap them on top of the container.

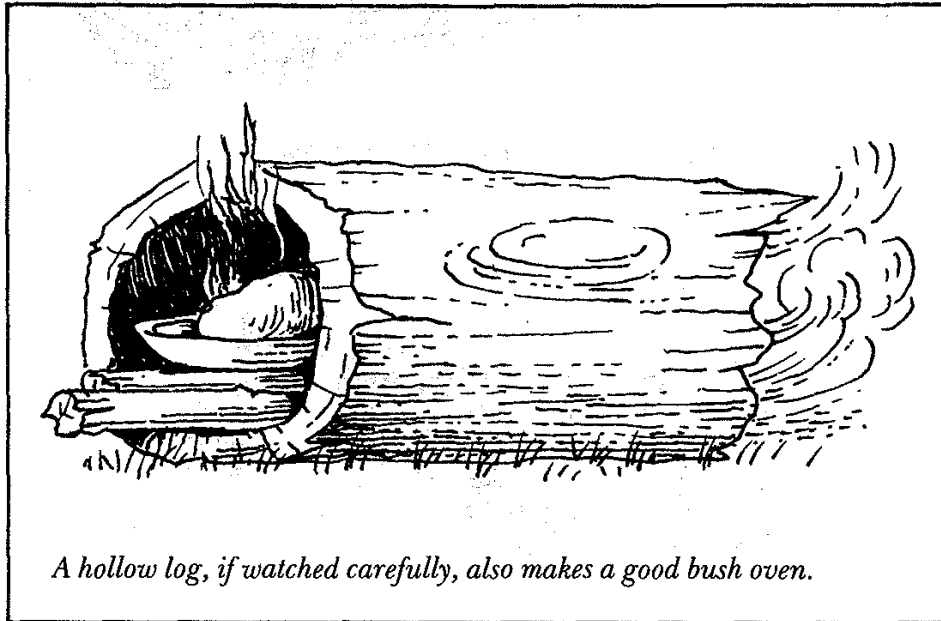

A hollow log, if watched carefully, also makes a good bush oven.

OTHER METHODS A hollow log or an old stump can make a moderately effective enclosed oven. Light a fire in the hollow and when it has burned down and the stump itself is smouldering, enclose the food you wish to cook completely and place it in the cavity.

It must be watched closely because the fire within the log may flare up. If this happens damp it down with a little water.

One of the best methods of baking is the age-old method of enclosing food to be cooked in clay. Not only was it used by the Aborigines but it was also a standard method of cooking in many other parts of the world.

The best results, in using this method, are gained if a pit fire is made and allowed to burn down until it is a mass of hot ash scattered through with live coals.

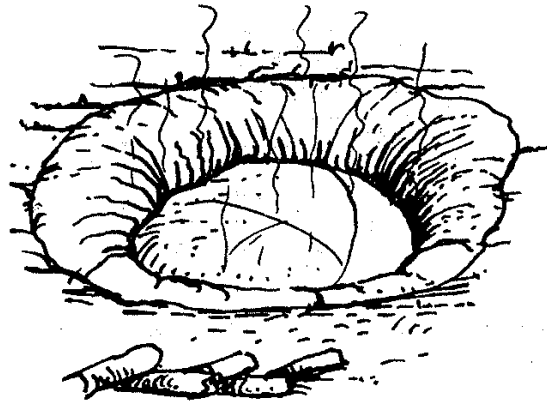

Pit cooking — or the earth oven method — is a most satisfactory method of slow baking or steaming of food.

The food to be cooked — whether it is a large piece of meat, a game bird or a fish — is completely enclosed in a thick covering of clay and buried in the ashes. If the fire is not built up again the food can be left for up to six hours without coming to any harm.

In the case of wild fowl the bird is neither plucked, nor gutted, but encased whole in the clay. After it is removed from the fire, when the clay is broken the feathers will pull away from the flesh and the intestines will have shrivelled up inside the carcass.

In the same manner fish can also be cooked whole, the scales coming away in the clay coating.

Another method for this type of cooking is to dig a hole and line it with large round (or at least semi-round) stones. The hole is then 'fired' by building a fire in the usual manner so that the stones are thoroughly heated. When the fire has died down the ash should be whisked off; the meat and vegetables to be cooked wrapped in leaves and then placed on the stones. The hole should be mounded over with earth and left to cook for several hours. The wrappings must be dense and secure otherwise the food will be either charred or covered with dirt.

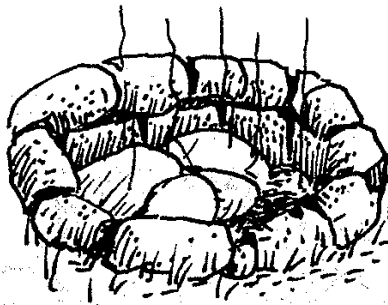

Another method of pit cooking. The pit is lined with stones which are heated by the fire.

This Aboriginal method of cooking is the simplest version of a style that runs through the whole of the Pacific Islands and is even seen in its *haute cuisine* form on the east coast of the United States where it is called a New England Clam-bake.

For a seashore pit fire, gather up a number of large rocks; stack them together with kindling and driftwood in a large pile. In the meantime gather a large quantity of seaweed. In this country, bull kelp is quite adequate and can be found in large quantities on surf beaches after storms.

Light the kindling-driftwood-rock pile and allow the fire to burn down and the rocks to get red hot. When the fire has been reduced to ashes cover the hot rocks with a thick layer of seaweed.

Tightly wrap fish, shellfish and crustaceans in individual parcels of seaweed and lay them on this steaming rock seaweed bed. Cover with another layer of seaweed and leave to steam for several hours. The rocks must be very hot and when the final covering is in place wisps of steam must be seen to be escaping from the mass. If there is no visible steam the fire is a failure and the food will not cook.

A celebratory pit fire in Hawaii is called a luau and in New Zealand a hangi. But celebration or not, it is an excellent method of cooking food. For a large party a pit about 1 metre deep, 1 metre wide and about 2 metres long is dug in

firm soil. Kindling and brushwood is laid on the bottom of the pit and rocks placed on the top. The fire is lit and more wood is piled on top of the flames to the level of the soil surface. When the fire has burned down and the rocks are almost red hot, the ash is brushed from the surface as much as possible. Green leaves are then thrown over the hot rocks and food in leaf parcels (tightly sealed) is placed on this surface.

The whole is covered with more green material and then the earth, previously removed from the hole, is shovelled over the whole. The fire pit is left to steam for up to six hours.

Modern tastes have decreed that the rocks should be heated in a separate area and then cleaned and put into the pit to prevent the food tasting of smoke. In bush cooking, smoke can be tolerated and also can be obviated to some degree by tightly sealing the food parcels in their leaf wrappings.

In a permanent camping area, whether inland or on the beach, this method of cooking has many advantages. If a party wants to go exploring, it can make its hangi or luau in the morning, seal it completely, knowing there is no danger of fire escaping and devastating the camp or surrounding countryside, and come home in the afternoon to a pleasant meal.

In tropical and sub-tropical areas the large leaves of the taro plant and the banana are usually used as leaf wrappings for portions of food. On the coast although kelp is excellent for the steaming of food, lighter types of rockpool seaweed, generally known by the all-embracing name of sea lettuce, should be used for wrappings. In the inland near lagoons, lotus leaves, traditionally used in China for almost 4000 years, can be picked and used for the same purpose. In other areas the Australian bush does not help. One must turn to the supermarket and aluminium foil, although large leaves of the *Ficus* species can be used for small parcels, if one can cope with the somewhat peculiar taste imparted by these leaves.



Eggs can be cooked in the ashes as long as their shells are pierced first.

BAKED EGGS An egg can be cooked by placing it in the hot ashes of the fire. However, the shell must first be pierced to allow the moisture to escape. If this is not done the egg will blow up much in the manner of a rock taken from a stream bed.

CLEANING WATER Water which is very muddy, dirty or stagnant can be clarified and made more or less safe for drinking



A pair of trousers makes a good water filter.

by filtering and boiling with hot stones. A good filter can be made from a pair of trousers with one leg turned inside out and turned inside the other leg. The bottoms are tied and the upper or body (waist) part held open by three stakes driven well into the ground. Fill the double trouser leg with the polluted water and then drop in the heated stones *gently*. The water will then filter down where it can be caught in a billy or other container. It should then be poured back until it is reasonably clear. In using this method, an experienced walker will add a couple of water purification tablets for good measure.

Camp Furniture

A comfortable campsite need not be made out of aluminium. A number of pieces of camp furniture can be constructed from deadwood on the site. It should be remembered in this *instant* age that many of the early European out-back settlers did not regard these structures as makeshift; they regarded them as permanent.

TABLES A camp table and seats are worth making if there are five or six people staying for some time in a semi-permanent place. The best type of camp table is one which also carries the seats. This design has now been carried over commercially into the barbecue or patio style of furniture and the construction method is no different.

For the framework select two forked stakes at least 8 cm thick and about a metre and a half long. The length of the stakes depends on heaviness of the soil and how far you will have to drive the stakes into the ground to make the structure secure. The lower end of each stake is 'pencil sharpened' and the top ends bevelled. The first stake should be driven well into the soil so that the lowest part of the crotch of the fork is about a metre above the ground. The prong of the fork should be pointing out from the length of the table. When this stake is set measure off the length you want your table to be — normally about 1 metre for comfort for six

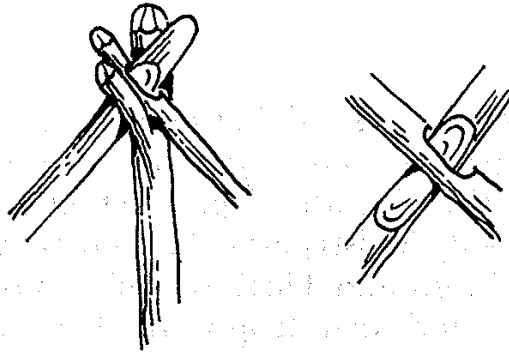

Methods of joining and matching the table stakes.

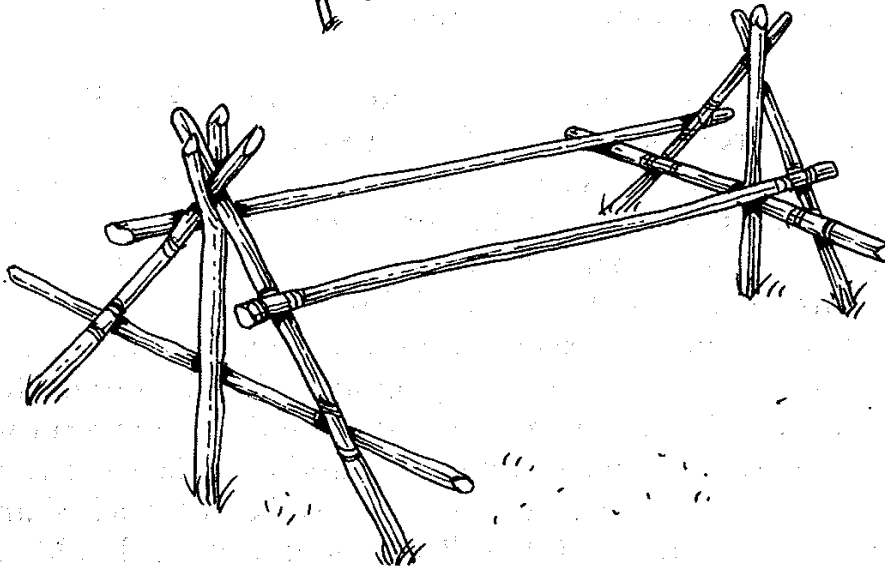
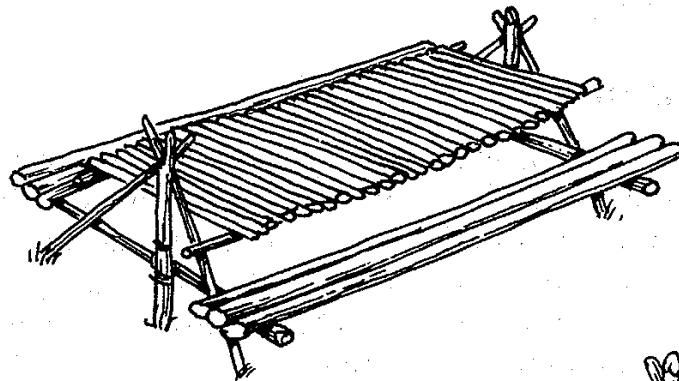

For a long-term camp a bush table can be easily constructed out of deadwood. As long as the table's surface itself is level, it can be made to any dimensions, although the length should not be longer than 2 metres. If longer it may sag in the middle.

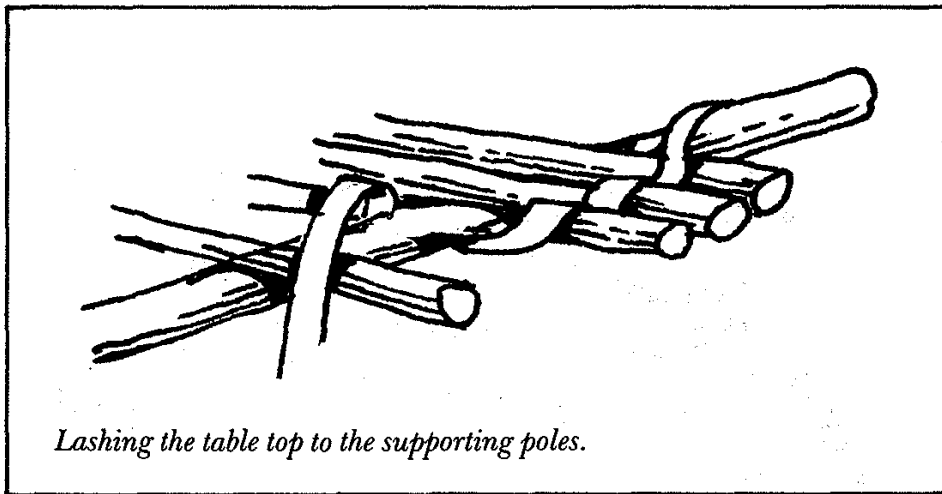

people. Then drive in the other stake, with its prong also pointing outwards, to the same depth as the first. Measure their relative heights by eye.

Then cut four strong, straight stakes and place these with one end in the crotch of the forks at right angles to the uprights. Drive them in securely as they will carry the weight of the table poles. Secure to the uprights with lashings if necessary.

Then lash the table support poles (see illustration) into position.

About 50 cm above ground level two straight poles about 10 cm thick and cut to the length required are lashed to the central stakes and the Y supports at either end of the table structure. They must be strongly fixed because they are going to support the seats.

The framework is now finished. Cut short, straight sticks for the top of the table and lace them to the tabletop poles.

The seats should now be assembled. On the cross seat poles, braced to the Y structure at either end of the basic structure, a number of poles of similar length should be placed. With binding at either end these poles can be used for seats. However cross-slat seat sticks can be laid on them. If the seats show signs of sagging in the middle construct a cutoff 'H' frame structure with lashings in the middle of each bench.

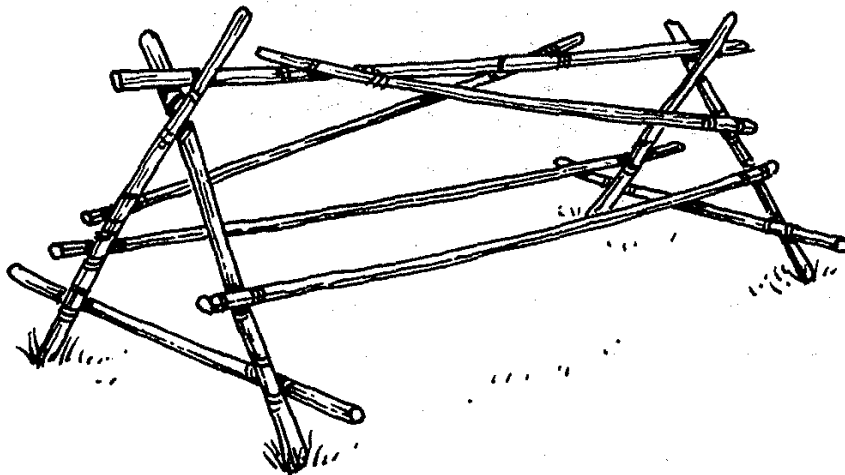

Bush tables can be made so they can be moved. When securely lashed, the framework shown above is extremely strong. A fly or a groundsheet thrown over the top pole can be used to shade food left on it while preparing a meal.

If the ground is soft or loose the table will require bracing. This can be done simply with two diagonal braces from the table level of the forked stakes to the foot of the other. Where the bracings cross they should be lashed. An alternative is to cut two more forks about 1.5 metres long and brace these so that they 'jam' below the forks of the stakes in the ground.

Their own butts must be firmly seated on the ground and held from slipping by a stout peg driven well into the ground.

If all of this is too exhausting in dry country a trench style of 'table' can be constructed.

Dig two trenches about a metre apart with enough room in their bases for people to place their feet. The trenches should be about 60-70 cm deep to allow campers to place their legs comfortably. The first sods from the trench should be put on each side and used as seats.

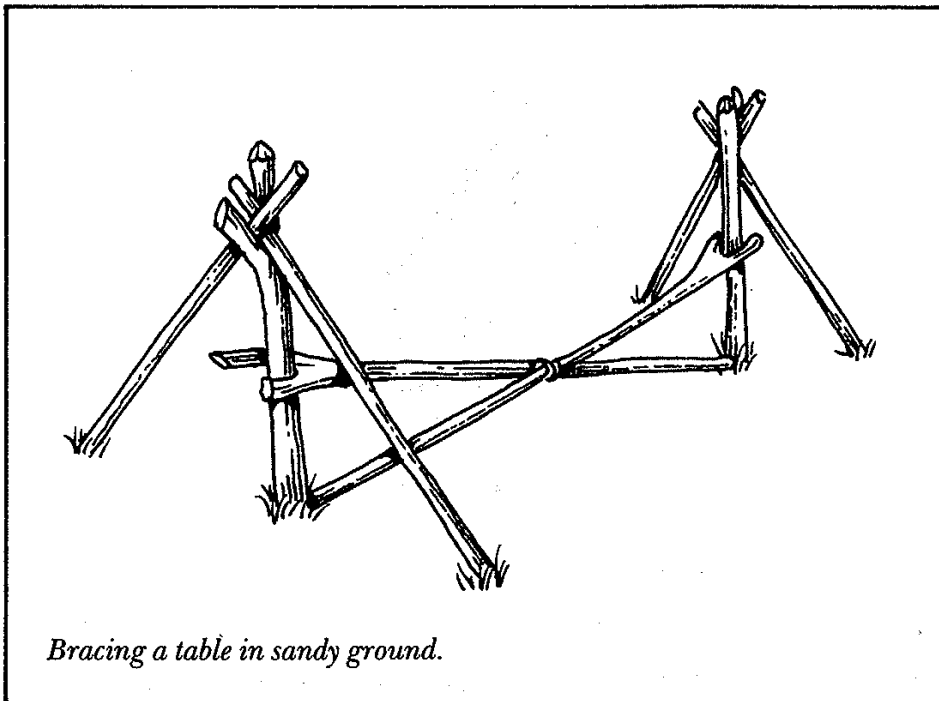

For added comfort seat cushions can be made of bundles of grass and dry bark and flat pieces of dry bark can be laid over the table top for a tablecloth of sorts. The tablecloth bark, with one assumes its bush spillings from various meals, can later be fed into the campfire to keep down flies and other food-seeking bush animals.

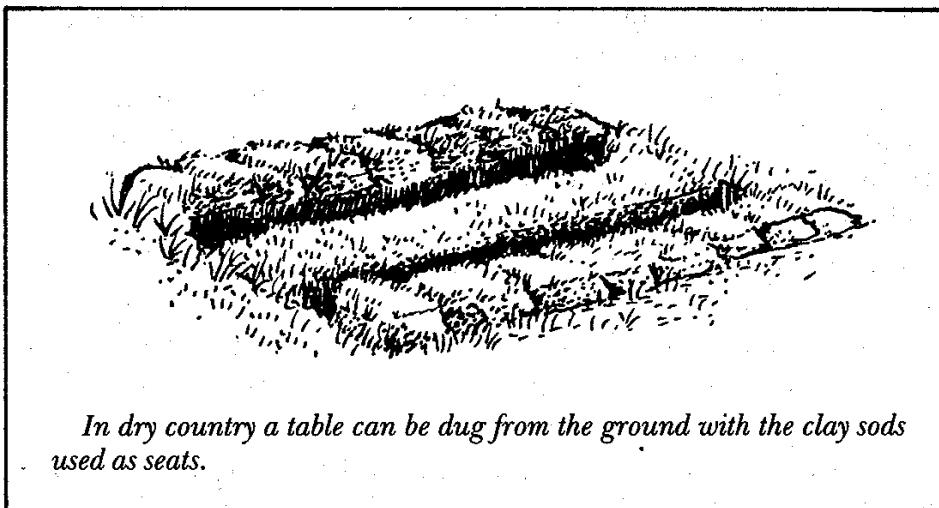

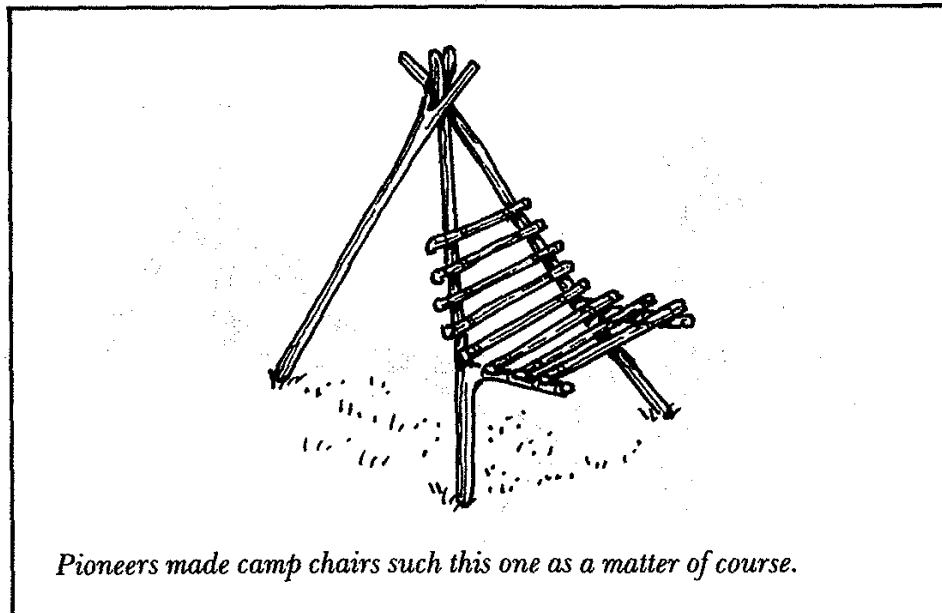

CAMP CHAIRS A camp chair can be made out of natural materials in a very short space of time and will give the person sitting in it hours of comfort — far better than squatting on the ground.

Select two stout forked sticks about 1.5 metres long. The forks of these sticks or poles must be at a wide angle and cut with the straighter of the two prongs about 25 cm long, with the other prong being slightly longer. Cut another stick slightly above 1 metre in length and leave the two prongs of this sufficiently long to hold *both* prongs of the sticks that have been previously cut.

Across the seat portion of the chair lash straight sticks about 3 cm thick and continue these up the back of the chair. On the seat portion they must be close together, but on the back of the chair they can be spaced further apart.

There may be difficulty in finding two sticks with wide-angled prongs, in which case the chair can be made by using two hooked stakes. The crotch of the hook should be about 20 cm above the end of the stick and the sticks themselves should be just over a metre long.

The side poles about a metre and a half long are laid one each through the hooked portion of the sticks which have

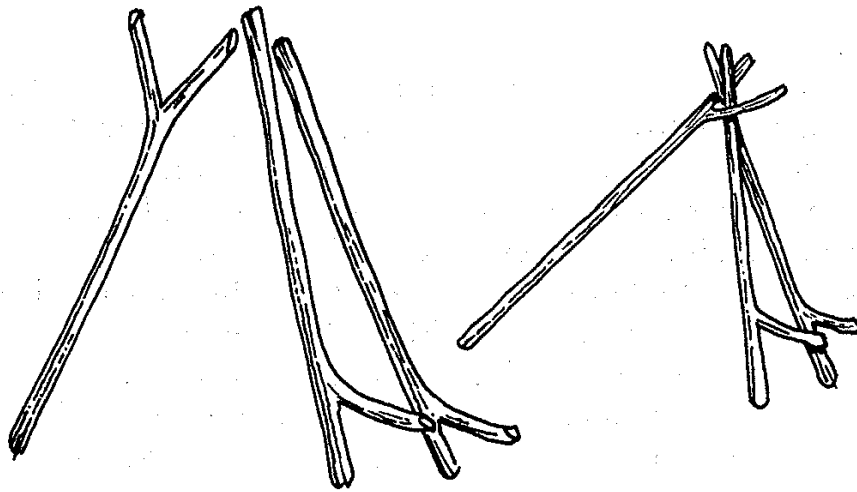

Three main poles are required for a camp chair. They can be of any length that is practicable.

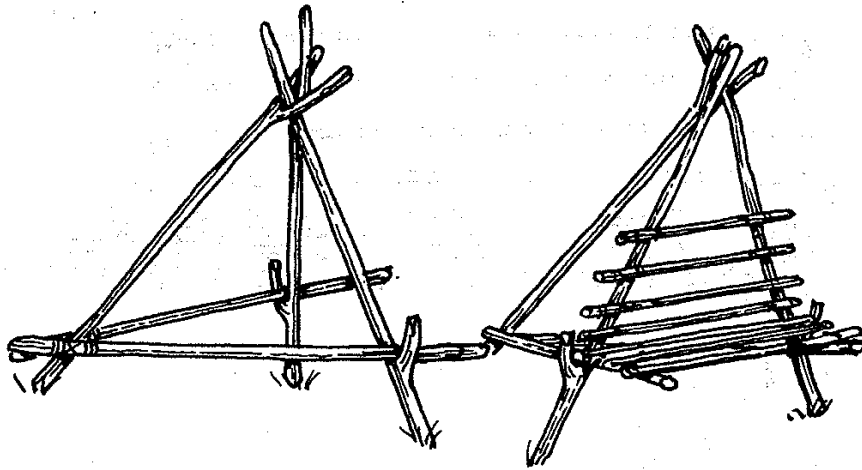

The framework of a chair, using hooked poles.

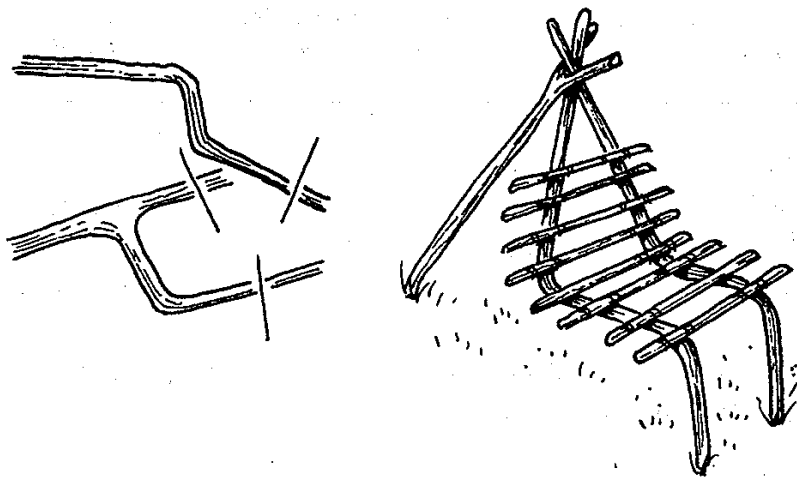

Twisted poles can be turned into a chair with little effort.

their upper ends lashed together. These two poles are then in turn bound to one another behind the chair structure and a forked pole, leading from the upper end, where the hooked stakes are lashed, comes back to these side poles and is lashed again. This gives the complete framework.

Sometimes limbs of trees are bent in an almost natural seat position and can be utilised without further ado.

Of course one doesn't have to go to all this trouble. A fallen log or tree trunk is equally good and a comfortable seat can be made from a couple of large rather flat stones.

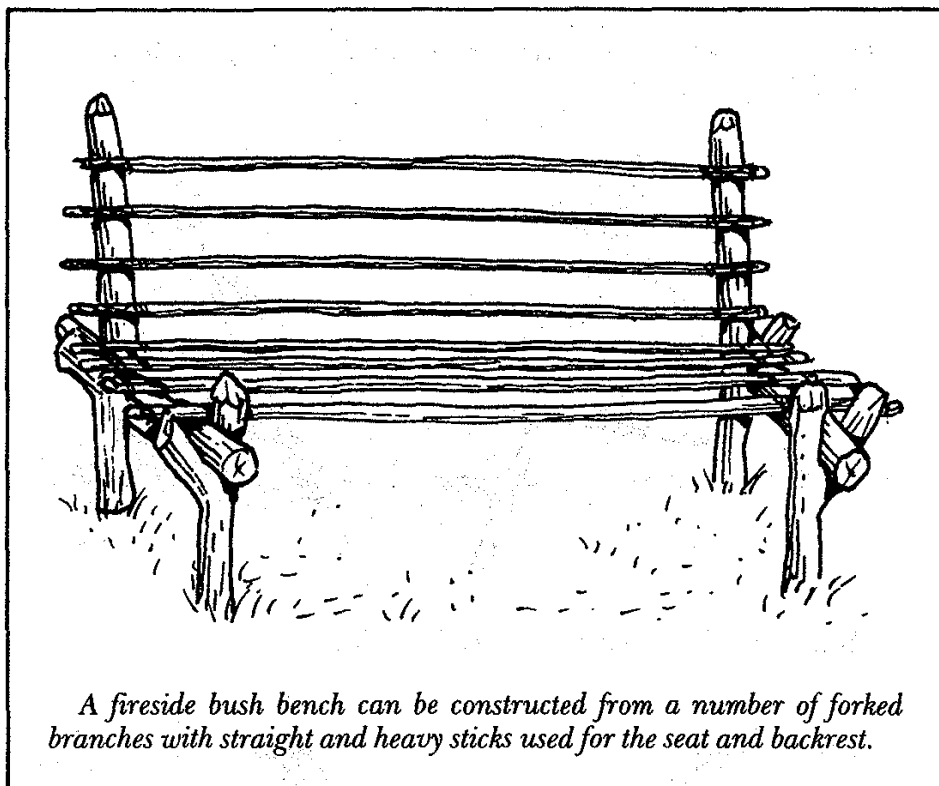

A fireside bush bench can be constructed from a number of forked branches with straight and heavy sticks used for the seat and backrest.

CAMP BENCH A very comfortable fireside camp bench can be made by driving two short stakes into the ground so that the forks are pointing outwards — that is, away from the opposite stake. The bottom of the forks should be about 25 cm above ground level.

Two *backed* fork stakes about a metre long are driven into the ground about 30-35 cm behind the two short ones. They

should be driven in at a slight angle leaning away from the front forks. Their forked sections should also point outwards.

All stakes should be about 5 cm thick to enable them to carry weight without sagging.

Cut two cross bars about 10 cm thick and fit them into place in the forks. Then, along the seat, lay a number of straight poles. These should be at least 5 cm thick and they should be close together. They should be bound at both ends. Along the back, lash similar poles.

Once finished this makes a very comfortable fireside bench for a permanent camp.

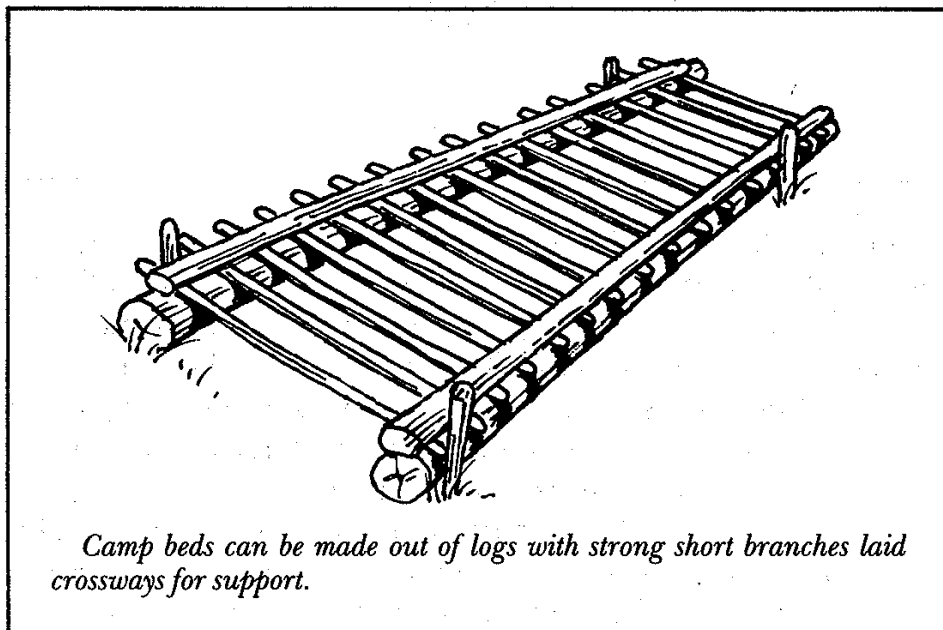

CAMP BEDS There is a maxim for people who want to live with the bush that a sound night's rest is worth 10 minute's toil. These days with lightweight air beds the art of bush sleeping construction has gone out of fashion somewhat. But once again there are times when there are no air beds — nothing in fact except for the bare ground which is both damp and full of stones. In cases like these it is a great help if you know how to make your own bed and then lie on it in absolute comfort.

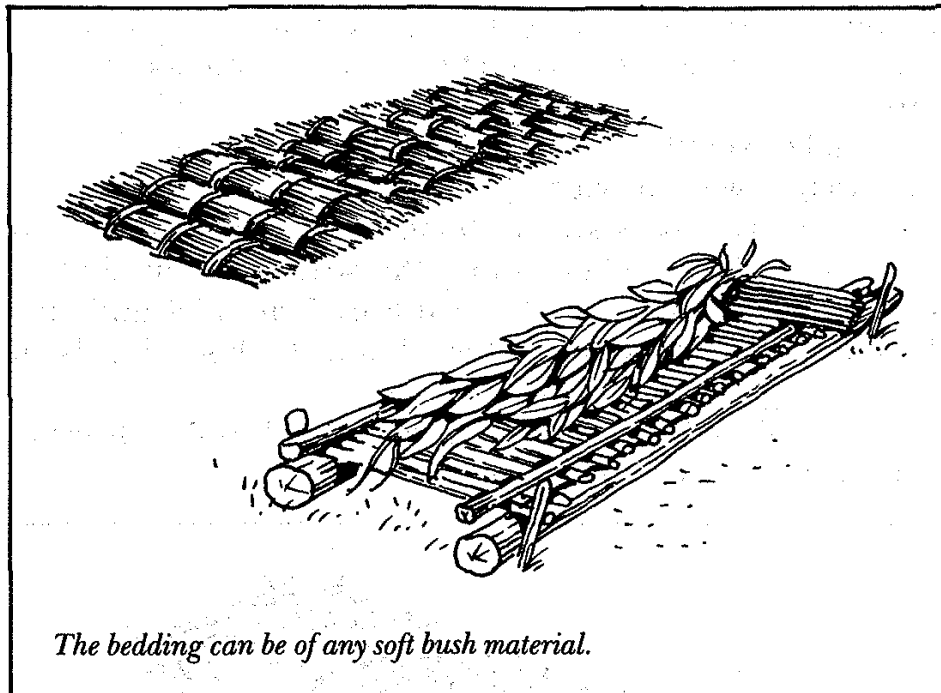

The bedding can be of any soft bush material.

Cut two long poles about 15 cm thick and about 50 cm longer than your own body. Lay these two poles parallel to each other about 1 metre apart. Peg them in to prevent them from rolling. Then cut a number of straight and strong sticks and lay them across the poles. They should be fairly close together. On top of these cross sticks lay another two poles. These should also be braced by the pegs.

On top of the whole structure make your bed. This can be of dried grass, ferns or green leaves — any waste or green stuff in other words. Make sure that it is deep enough to absorb your body weight. This will ensure that you have both a springy and a comfortable bed.

ABOVE GROUND CAMP BEDS In the first instance construct a framework similar to the bush table already discussed. The framework is then overlaid with sticks in a similar fashion to the ground bed. Make the bedding out of the same available material.

Another alternative is to support the ground pole bed on pillars of stones.

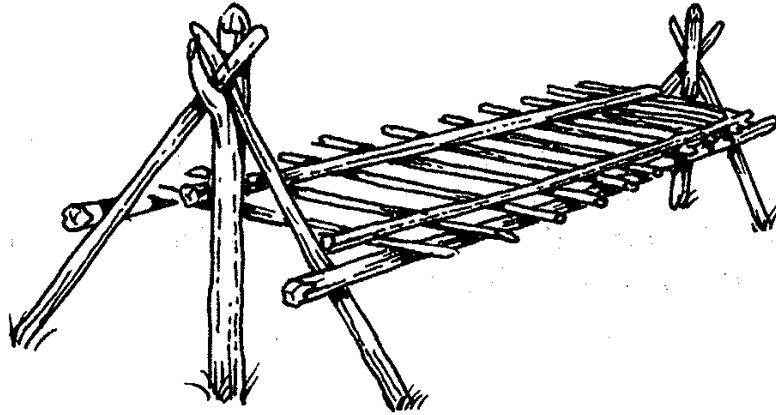

A camp bed off the ground is supported by a triangle of stakes at both ends.

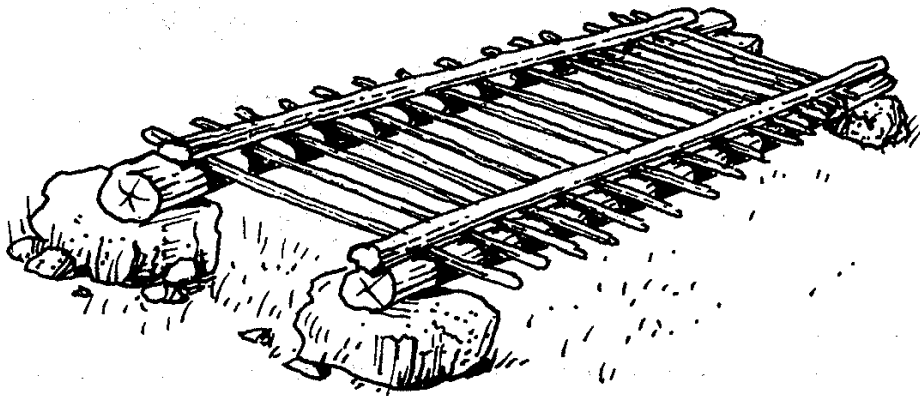

Rocks can be used to make an above-ground bed.

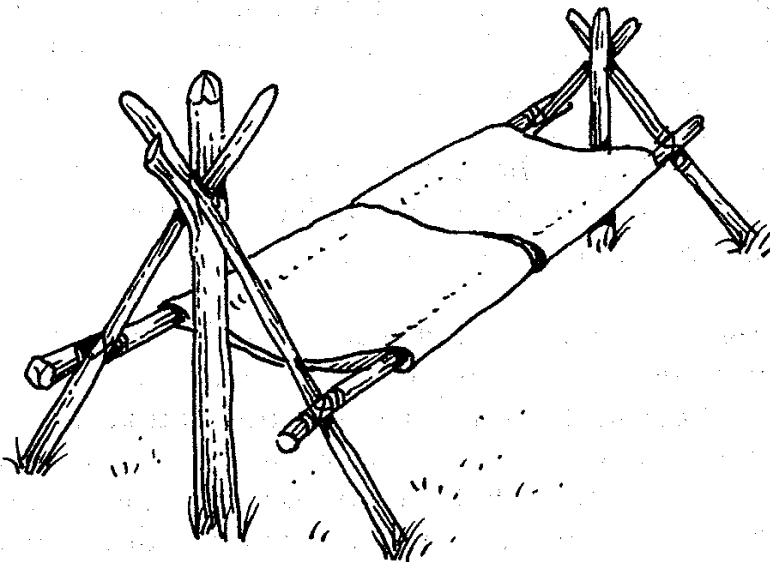

Canvass bags were often used in the past to make a comfortable hammock-like bed.

A camp bed may also be made by using hessian bags as the bedding (see illustration). The bags are simply fitted through the poles before they are placed in position. The bags can be left as they are or filled with dried grass or ferns before the poles are slipped through them.

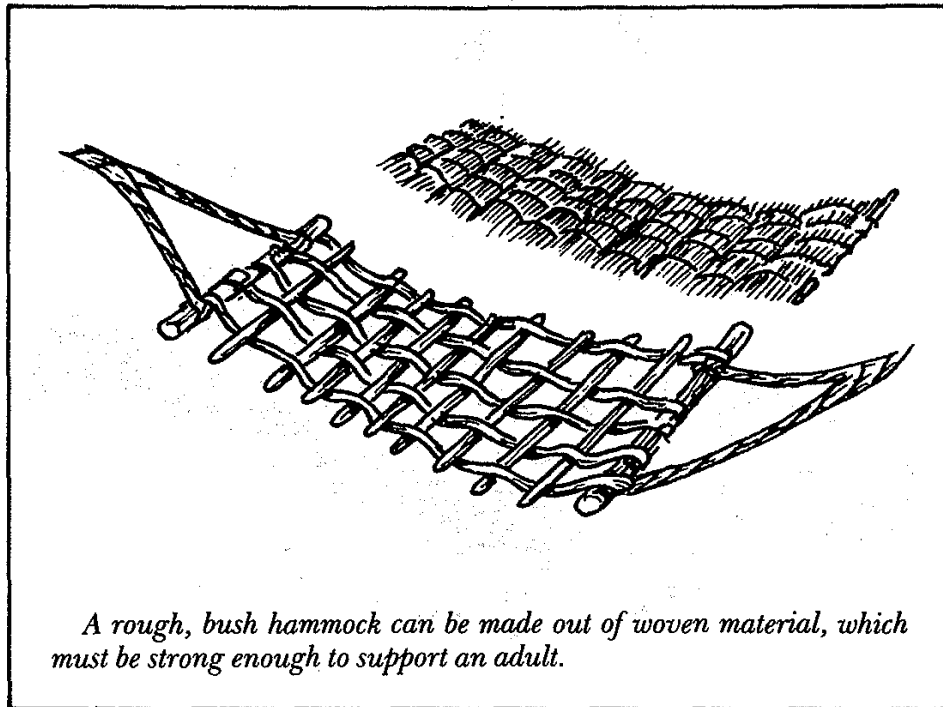

STICK HAMMOCK A plaited hammock bed can be made by braiding bush material into a mat and then sewing the ends of this body-length braided mat onto two supporting strong sticks at least 5 cm thick.

Palm fronds are the best material for this sort of net although it can be made from braided hammock grass rope, which is a very laborious process.

BUSH LADDER A bush ladder is easily made. Select two long, straight poles cut to equal length. Lash the thin ends together. Spread the butts or thick ends so that they are at least a metre apart (if they are any narrower the ladder will be unstable). To those lash the rungs and make certain that the lashings are good and tight. This ladder will be especially

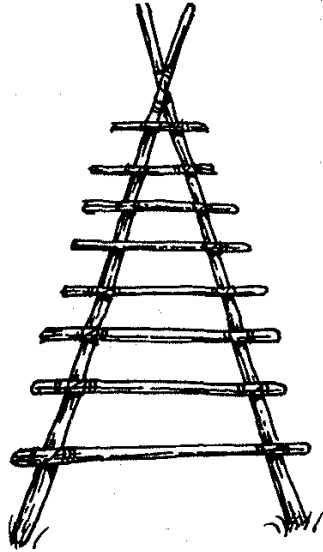

The bush ladder is made in the form of a tepee or extended triangle. At ground level the support poles should be at least 1 metre apart otherwise it will not be stable.

useful in the construction of bush houses as it enables those thatching and tying on bracing poles to climb without putting strain on the house structure.

SLUSH LAMP A lamp for the camp can be made by filling an old tin or small hollow piece of a tree branch with soil that has a heavy clay content. It should be packed tight at the bottom and come to within about 3 cm of the top of the container. Into this a twig wrapped with cotton rag or encased in finely teased out bark fibre is inserted. This is the wick. Fat from cooking is poured on to the top of the earth and allowed to set. When the wick is lit the 'candle' should burn with a clear flame.

BOTTLE CANDLE HOLDER An open flame in a tent is dangerous. A candle holder or glass cover for a slush lamp can be made by cutting off the base of a clear glass bottle. This can

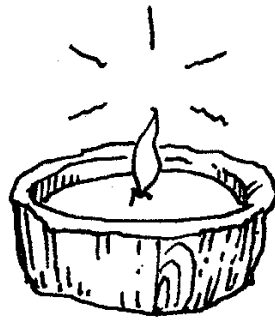
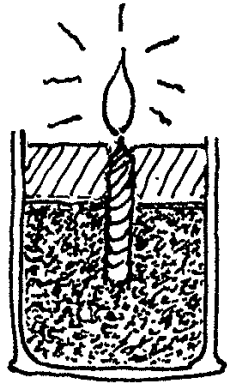

Use a tin or a dead eucalyptus knot for a slush lamp. On dark nights they provide guiding lights and save torch batteries.

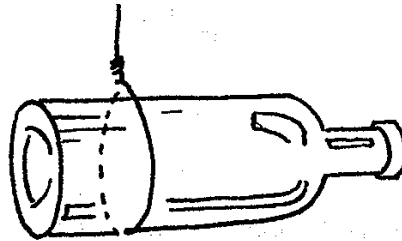

A windproof candle holder can be made from a bottle — there are plenty in today's bush — cut by using a red-hot wire loop.

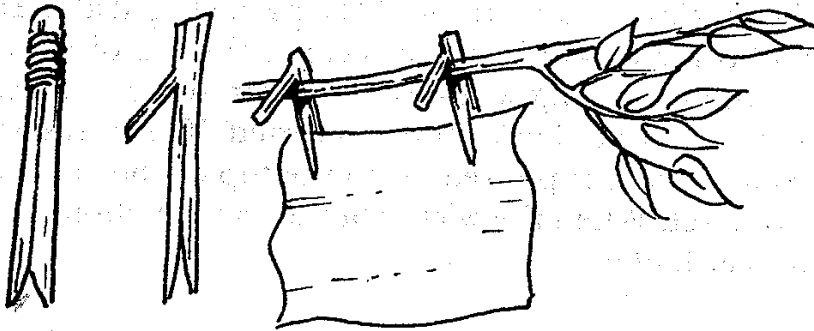

Clothes' pegs can be made by the old gypsy method of splitting sticks.

be done easily by heating a piece of wire until it is red hot. This is then bent around the bottle at the point where the cut is required. Alternatively a piece of grease-soaked string can be tied around the bottle at that point and set on fire. When the wire is in place on the bottle plunge it into cold water. The glass should break off evenly along the line of encircling wire.

CLOTHES PEGS Clothes pegs can be made quickly and easily by gathering some half green sticks of any desired length — 10 cm should do — and splitting them after binding one end. Forked sticks can also be used in this manner — the fork hanging from the branch of a tree.

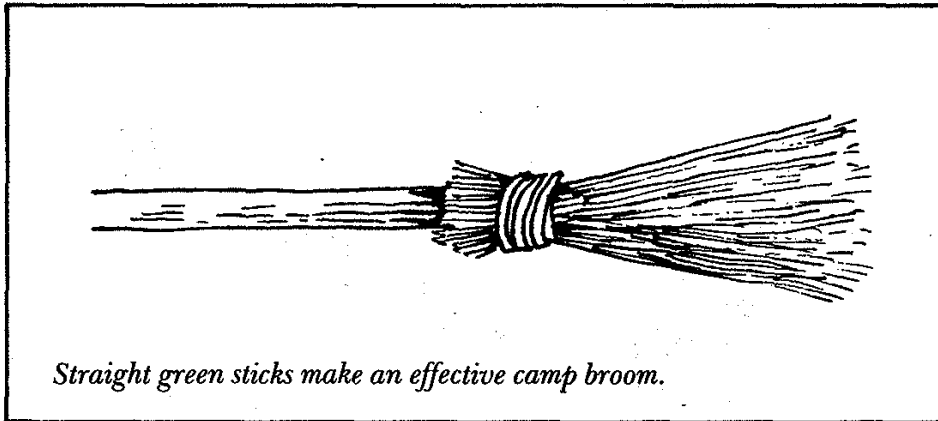

CAMP BROOM A bundle of straight green sticks, each not much thicker than a matchstick, is collected and bound tightly to a central handle. The business end of the broom is then trimmed off evenly.

BUSH HOE Select a dead or half-dead branch of hardwood between 10 and 15 cm thick with a side branch long enough to provide a handle — anywhere from 1 to 2 metres — coming off it at a fairly wide angle. Trim the side branch so that it is smooth. Using a machete or tomahawk, trim the main branch so that it provides a hook or hoe blade. Sharpen this hoe head roughly to a chisel shape. This makes quite an efficient digging tool, especially if the end is hardened in a fire.

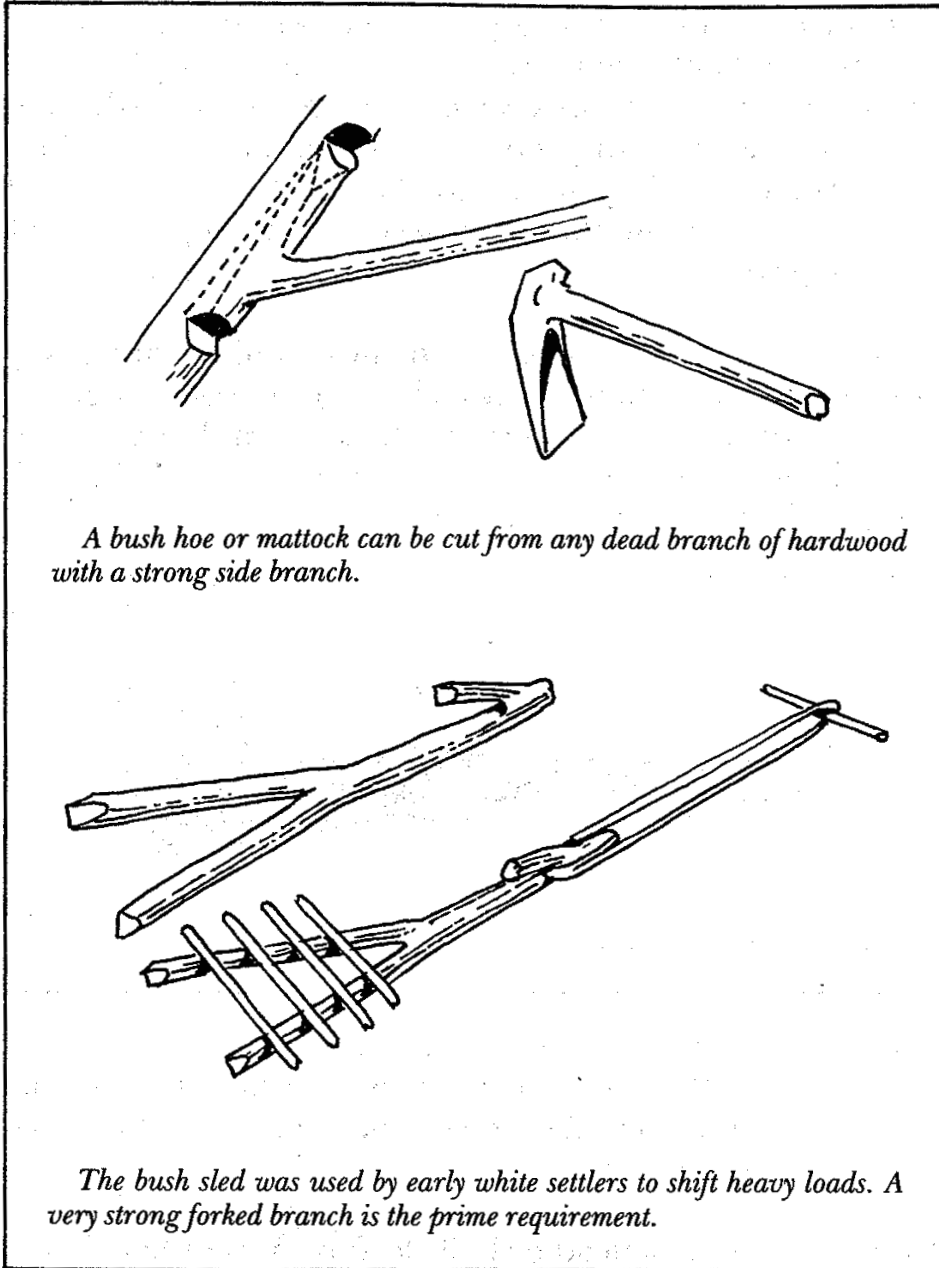

BUSH SLED An improvised sled can be useful in camp for dragging heavy loads — large rocks for the fireplace or bush oven for example. Take a forked branch of a tree — one in which the two forks extend up to a metre beyond the main stem. A rope is then fastened onto the stem end and cross sticks lashed to the forks.

CAMP LARDER A camp larder is simply a platform thatched along its sides and at the roof.

The object is to ensure that the interior is both dark and cool. The darkness helps to keep the flies away and any lowering of temperature helps food keep better.

It can be considerably improved by placing a tin of water on top of the thatch roof. A few pieces of rag are inserted in the tin full of water and allowed to fall on the roof surface. The water will then slowly drip along the roofline and down the sides of the larder. It also helps if the larder is positioned so that it catches a regular breeze.

Other methods of storing food in camp to keep it away from animals include placing it in a hollow log wedged in the crotch of a tree, suspending it from a bough or making a platform and hanging this from a branch in a shady position.

If ants are a pest, a suspended platform is about the best way to keep them away from the food. If they do find the cord they can be prevented from travelling along it by tying a kerosene-soaked rag around it. Another method is to

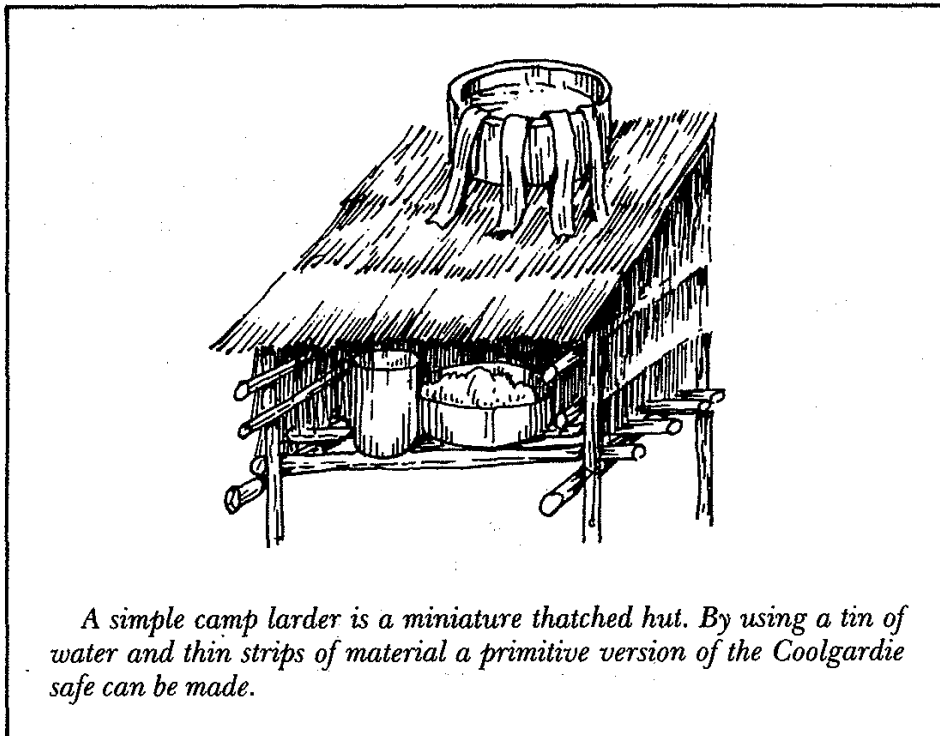

A simple camp larder is a miniature thatched hut. By using a tin of water and thin strips of material a primitive version of the Coolgardie safe can be made.

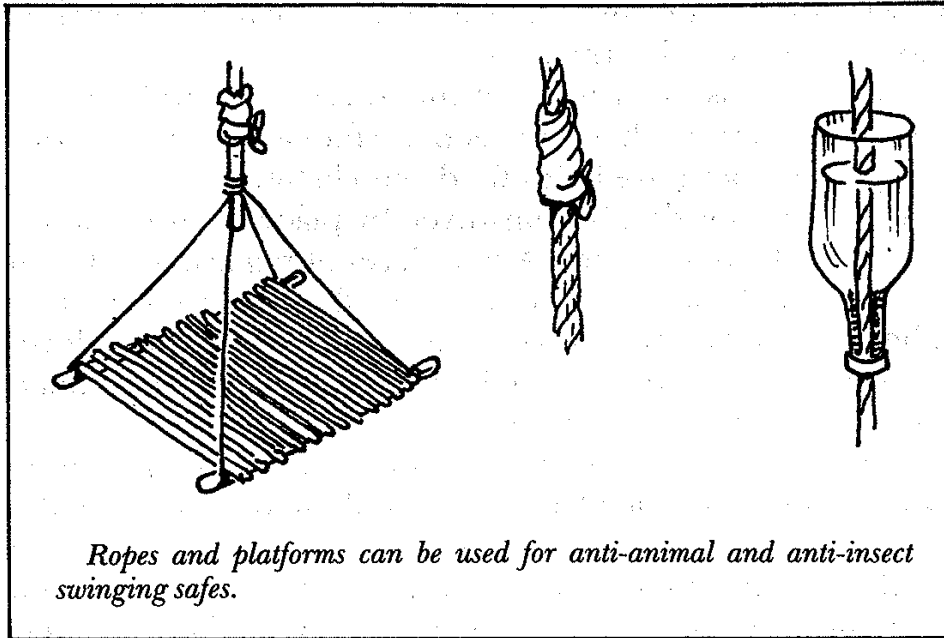

break a bottle off above its neck, passing the cord through its cork and then, after packing clay around the rope inside the bottle, filling it with water. Water, of course, will soak down the rope so the bottle will need filling from time to time.

CLOTHES HANGER Usually in camp one's travelling clothes become crushed and soiled. This can easily be prevented by making a simple coat and trousers hanger. If you take off your travelling clothes immediately on arrival in camp and put them on such a hanger they will remain fresh and uncreased.

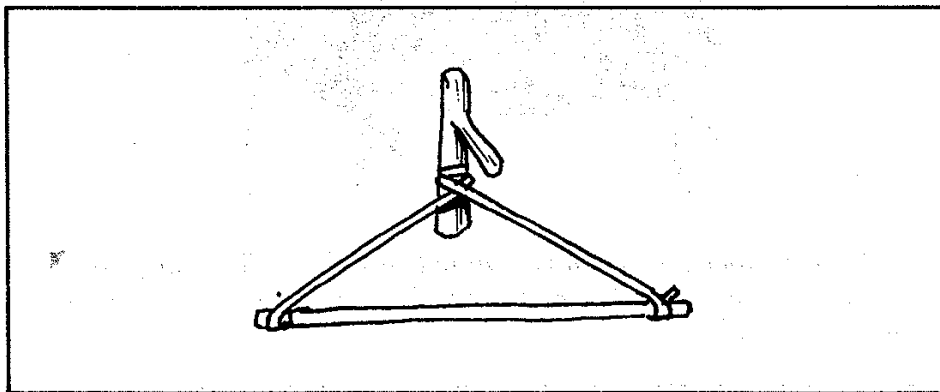

The swag and other improvised gear

The swag is the proverbial means of carrying a load and it is one of the best methods in existence. It has the advantage of being extremely well balanced, two-thirds of the weight being carried behind the body and about one-third in front.

The result of this balance is that the carrier walks completely upright. Clothes, tent, bedding and the gear not wanted for the day's walk are carried in the swag at the back, while the food and cooking utensils and the day's needs are in the 'dilly' bag in front.

Because of this the swag is not opened during the day but the dilly bag attached to the front is immediately accessible.

The only materials necessary to make a swag are a strap, two binding straps and the dilly bag. The swag strap, preferably of soft leather or light webbing, should be about 1 metre long and about 5 cm or more wide. The two binding strips

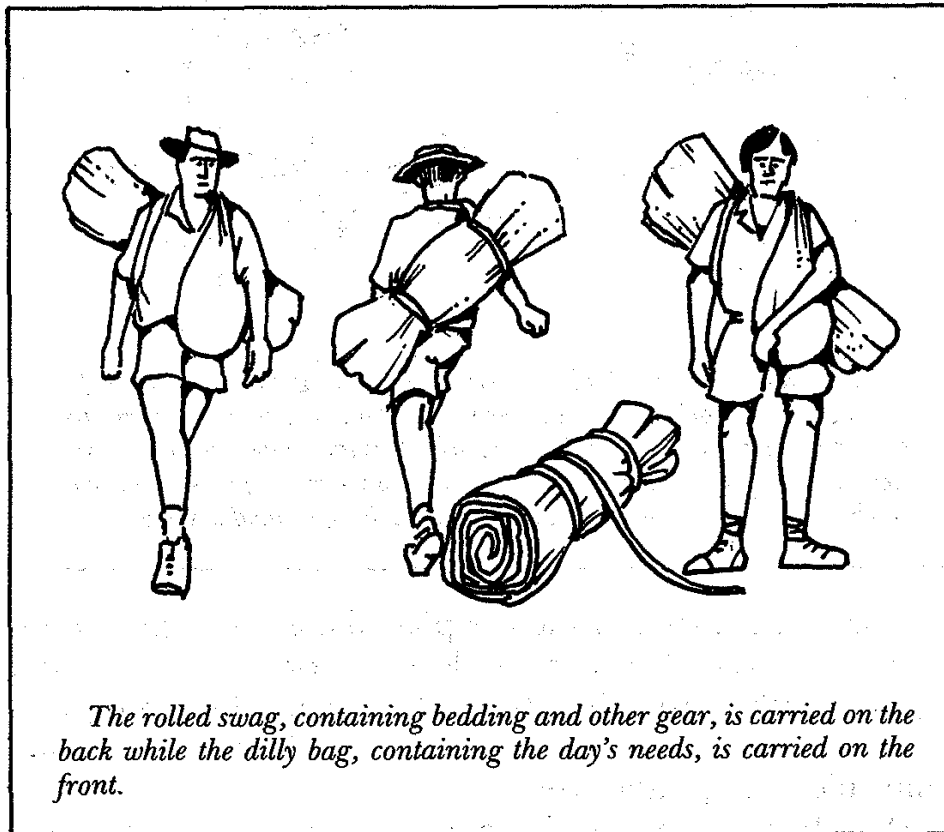

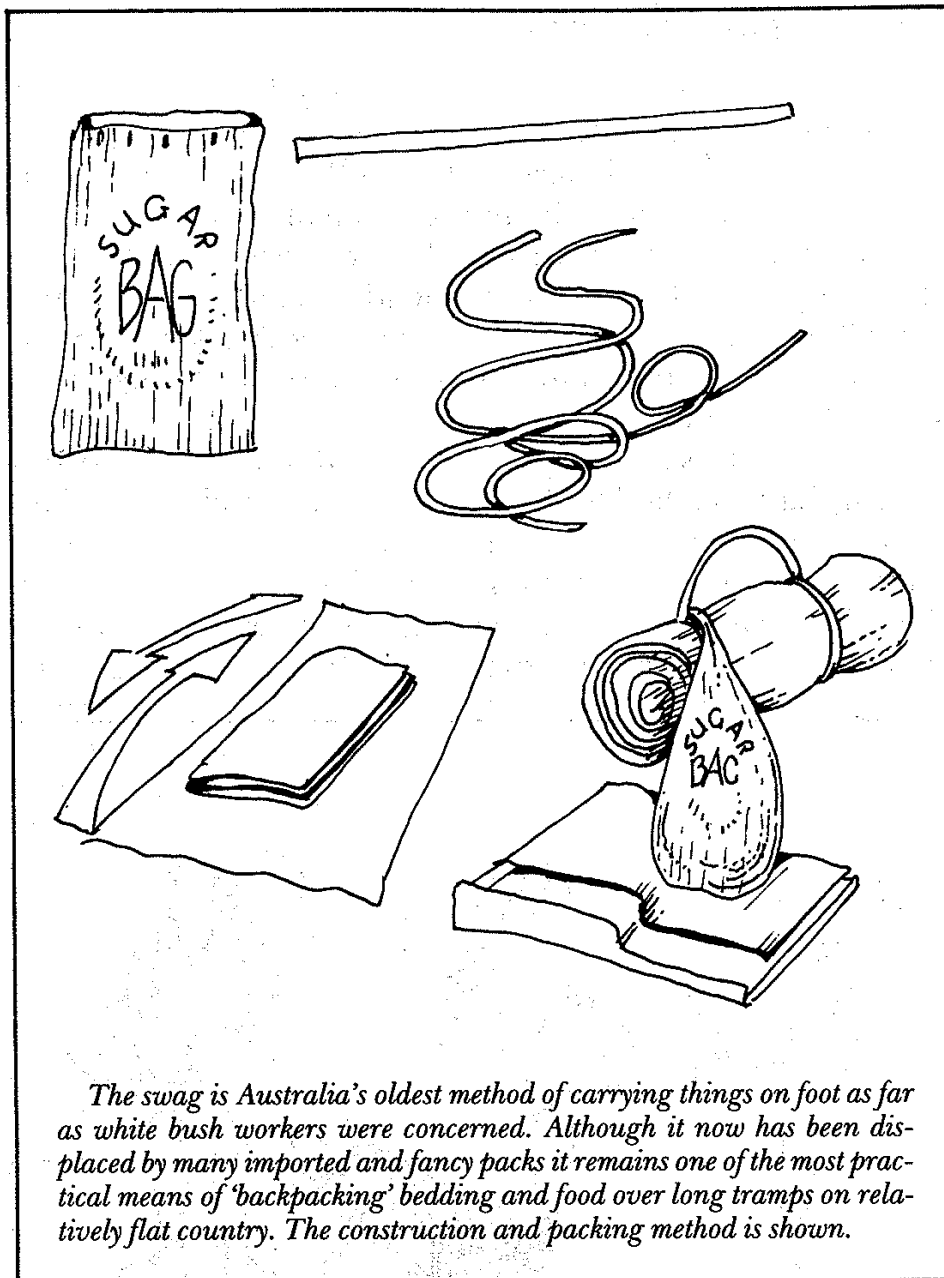

can be of any material such as plaited cord or rope. Traditionally the dilly bag was an old sugar or flour sack, but a nylon weatherproof bag that allows some breathing (because it is also used to contain the day's rations) can be of any convenient shape and size.

Half the knack of carrying a swag consists in knowing how

to swing it. Lay the roll, with the dilly bag extended, in front of you. Put the arm farthest away from the dilly bag through the swag strap. Heave the roll towards your back and swing the body towards the swag, so that the dilly bag flies up and out.

Duck the opposite shoulder and catch the dilly bag on it. The strap will then lie over one shoulder and the dilly bag over the other with the swag roll carried at an angle across the back.

An alternative method of carrying the swag is to use two straps, one about 1 metre long and the other about 2 metres. Both straps should be about 3 cm wide and made of strong material, although it should be soft. The roll is made for the swag and the long strap tied securely about 15 cm from one end of the roll. Fifteen cm from the other end of the roll the other strap is fastened, with the dilly bag held in position by this binding.

The swag is lifted to the left shoulder with the dilly bag in front and the roll at the back, the neck of the dilly bag hanging over the left shoulder. The long strap is passed on top of the right shoulder and then under the armpit and around the back. Then it is tied to a loop at the bottom corner of the dilly bag. This type of swag prevents the dilly bag from swaying.

To pack and roll the swag itself, lay your groundsheet or swag cover (traditionally a blanket) on the ground and then fold your other blankets to a width of about 80 cm. Lay spare clothes lengthways on top with your other gear. Fold in the sides of the groundsheet and roll the whole from the blanket end to the free side so that it is tight.

If a tent is being carried, this 'inner swag' is then rolled in it. The two binding cords are passed through the swag strap to stop slipping. The dilly bag is then attached to one of the binding straps at its junction with the swag strap.

THE ADIRONDACK PACK This 'woods' pack, originally made by American fur trappers, is an improvised method of carrying heavy loads.

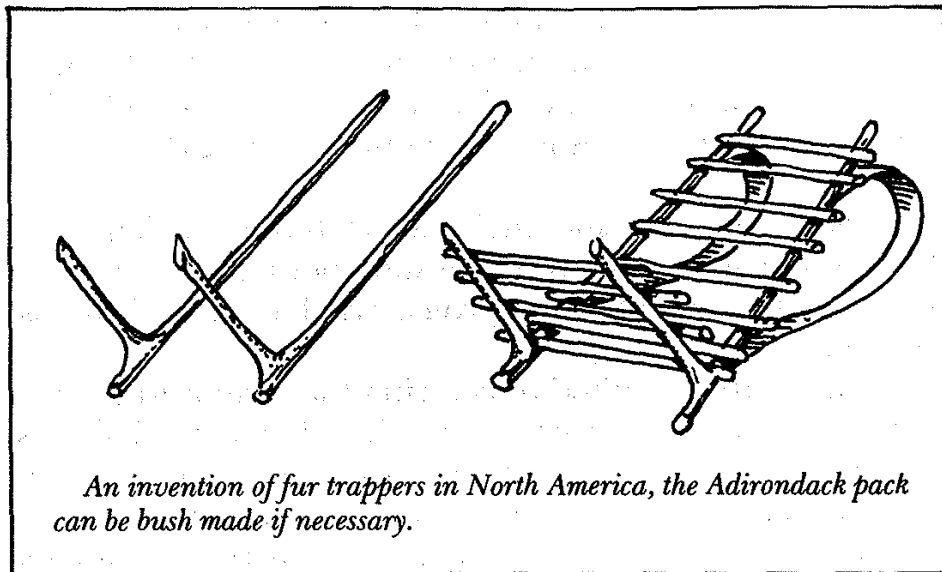

Select two light, widely splayed hooks, with the carrying arms about 60 cm long. The shank portion should be about 1 metre in length. It is better to use dead wood which is well seasoned because it is lighter. A number of short, straight sticks are lashed to the inside edge of the shanks above the arms and two straps are woven or plaited. These are tied to the lower end of the shank and again about 50 cm higher up. Where the straps are placed at the upper end the distance between the two shanks should be about 30-40 cm.

The load is then tied to this 'open basket'. Traditionally a tump line or headband was also woven and attached to this sort of pack, as well as the supporting shoulder straps to steady the load.

PANNIER PACK This carrying basket is of American Indian design. The basket itself can be woven from canes, rushes or any pliable material. Two woven straps are attached. The Indians, like the trappers, used a headband or tump line to steady the packbasket. It was widely used, because of its relatively small size and compactness, for stowing gear in canoes and very little for overland journeys. A canvas imitation of this packbasket, known as a Duluth pack (complete with tump line), is now used by American canoeists.

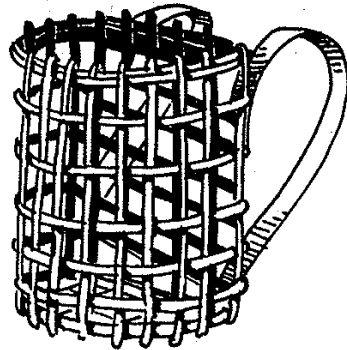

The Indian packbasket or pannier pack is good for short hauls.

River crossings

There are many ways of crossing a river without the aid of a bush suspension bridge or a rope line.

As long as the river is slow moving and a crossing point free of dangerous snags can be found it is quite easy to swim over and keep one's gear dry at the same time.

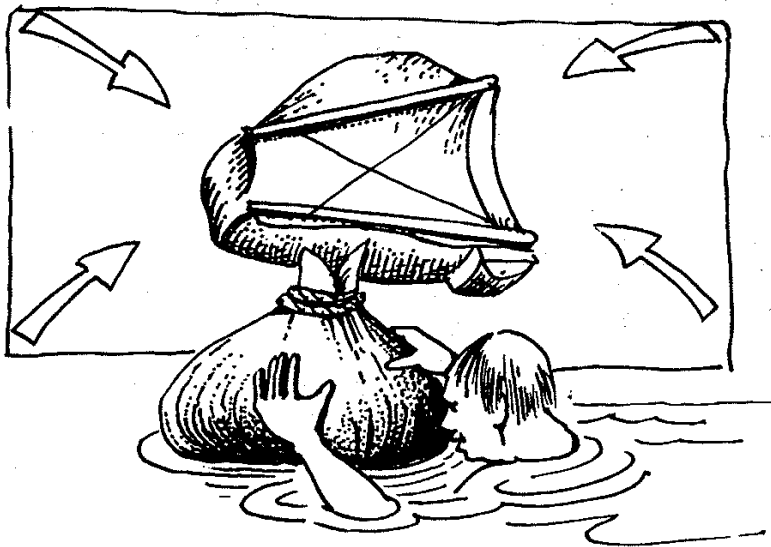

Packs can be dry-swum across any river as long as they are securely wrapped in a waterproof groundsheet.

The pack can be wrapped in a groundsheet which has its corners and loose folds tied together. If it is a framed pack it may be necessary to remove it from this frame. This will usually support the swimmer, who can hold onto it and kick his way across the stream.

The waterproof groundsheet should be tied extremely tightly at the top to retain air. It is always advisable to test the buoyancy of the pack before plunging ahead. Some heavy packs will simply sink to the bottom.

Do not attempt to swim across a river while wearing boots. These should be placed with the pack in the groundsheet.

A method of improvised water travel for poor swimmers or non-swimmers is to use two plastic bags which can be inflated and used much in the manner of water wings. These will support the poor swimmer and he or she can be escorted by other members of the party who are not encumbered by packs or other baggage.

A pair of long pants can also be used to support a non-swimmer. The trousers are wetted and the bottoms tied in a knot. The trousers are then plunged into the water by the waist so that air is trapped in the tied legs. The crutch is put across the chest and the two legs under the arms. Once again, the hiker is escorted across the river by two strong swimmers.

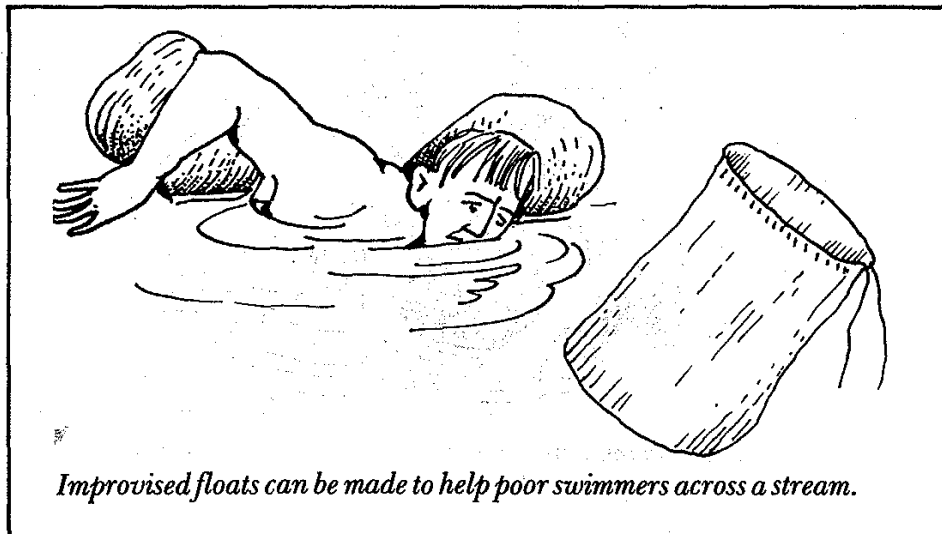

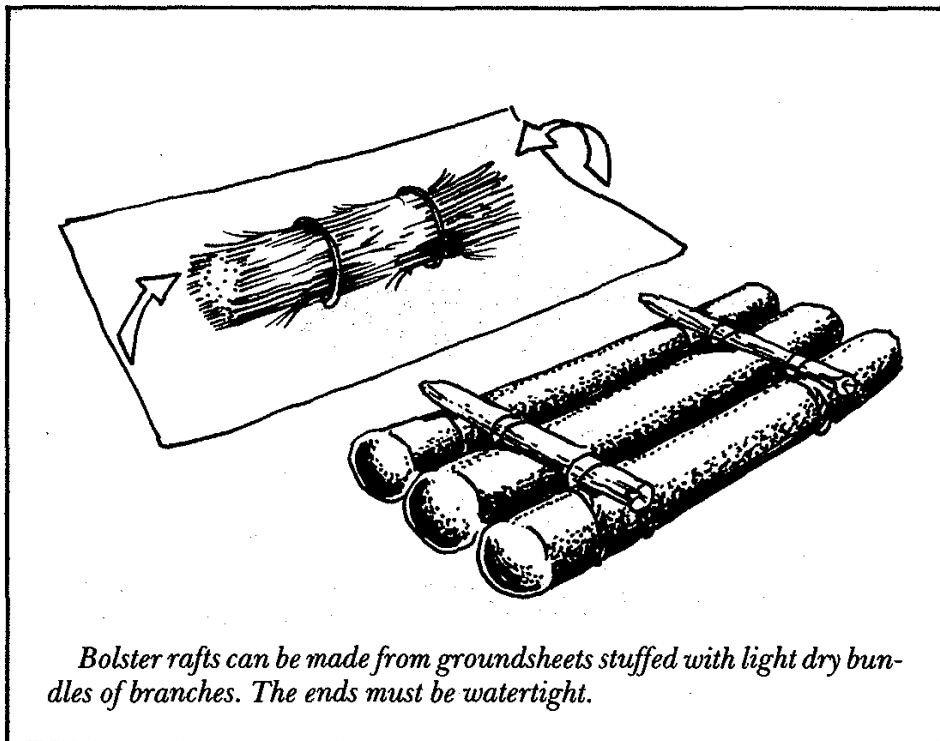

RAFTS Rafts can be made in many different ways. One of the simplest is to gather bundles of highly buoyant material such as bundles of sticks, dried reeds or brush, and roll them in a number of groundsheets which must be sealed at both ends (much like sealing a brown paper parcel).

Three or four groundsheets are then joined together with rope or twine and stabilised by two or more poles being lashed to their top.

These rafts, which will not support too much weight without submerging, can be used to ferry gear across a stream. Three of them will normally support one person at a time.

It goes almost without saying that inflatable mattresses serve the same purpose as rafts. Many bushwalkers now pack these as a matter of course.

A stronger raft can be built up from dry driftwood. The poles are secured by lashing and further stabilised by cross beams, which are also lashed to the supporting logs.

In using the raft a few basic rules must be observed. When travelling upstream, if the current is strong, the raft must be

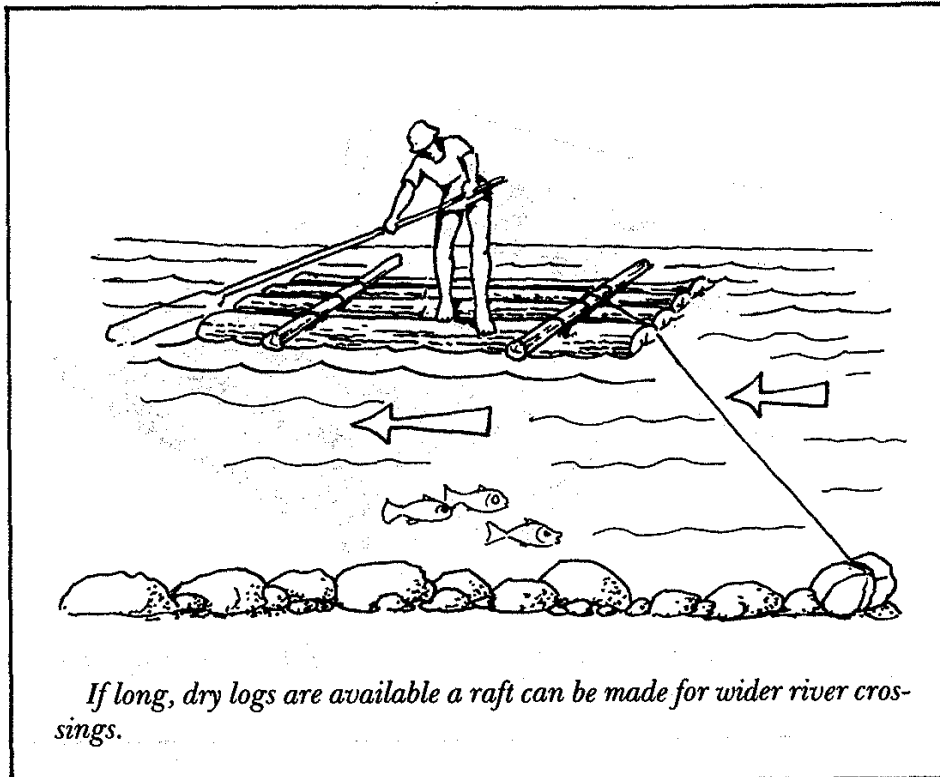

towed from the bank by means of a long rope. When traveling downstream, a 'kellick', made either from a log of hardwood or a heavy stone, is dragged astern in rapids.

A sweep or long paddle ahead enables the raft to be steered. The water sweeping past the structure travels faster than the raft and this provides 'steerageway' in reverse.

BARK CANOE Where timber is plentiful and the destruction of a large, green tree is permissible a bark canoe can be made.

The bark of the chosen tree must not be brittle, but should be reasonably pliable. It should also be fibrous and easily stripped from the tree. The barrel or trunk of the tree itself must be straight and free from branches and knotholes.

The bark is cut around the lower portion of the tree. Then a ladder is made and it is ringed again 5 metres or more above this first cut. A series of zigzag cuts are then made down the length of one side of this bark circle.

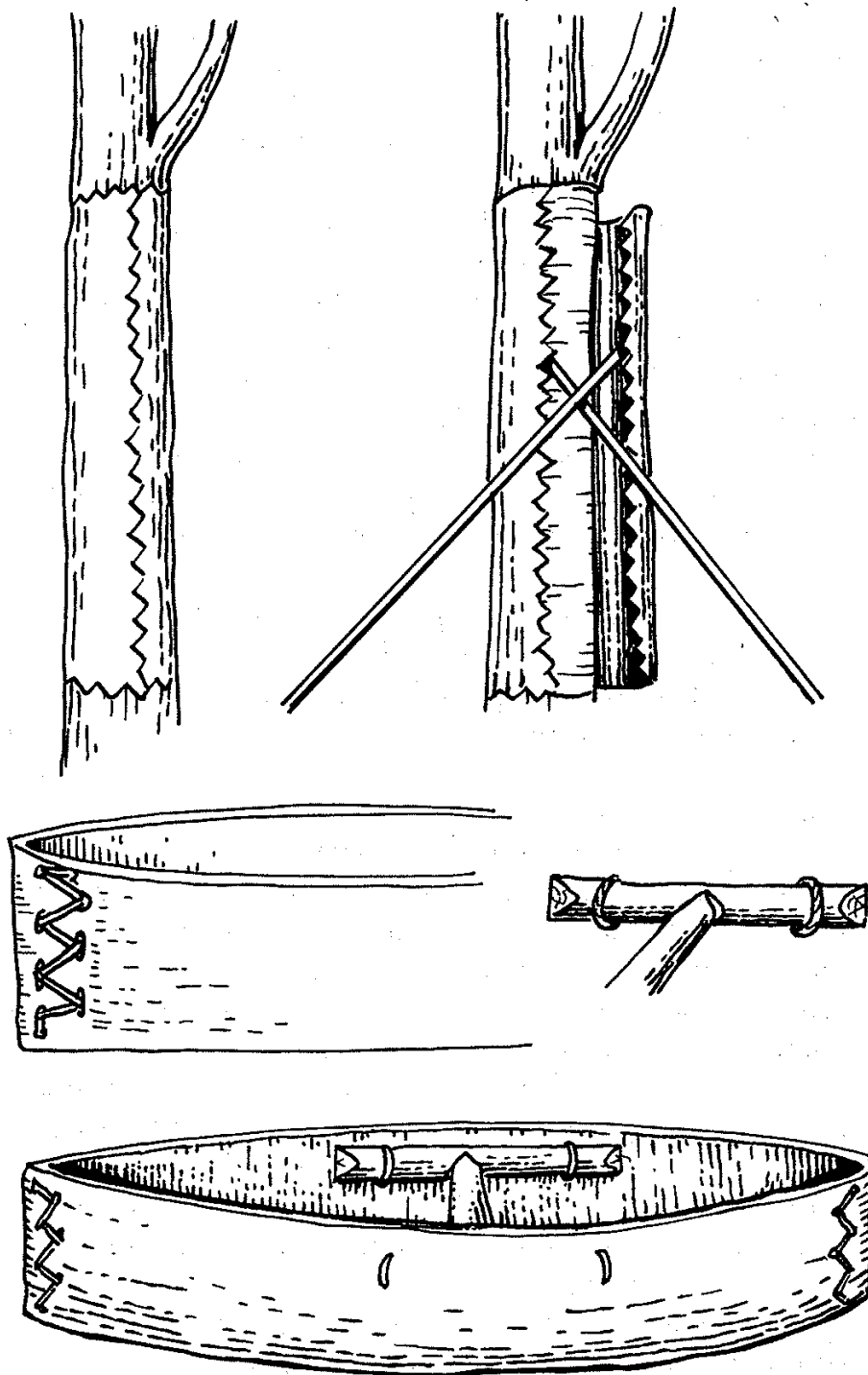

The method of construction of a bark canoe is shown above. The bark must be pliable and the whole canoe well-caulked and well braced for it to be successful.

The entire sheet of bark is then lifted from the tree by the use of two long poles, which have a chisel shape at one end. These are inserted into the vertical cut and worked up and down under it. It will gradually spread out from the tree, coming off in one sheet. This is a painstaking operation and it must be conducted with some care.

Lay the bark on the ground in the form of a tunnel. A small fire of leaves is lit along the length of the cylinder. The heat will drive the sap, in the form of steam, through the dry outer bark, making the whole sheet pliable.

The whole sheet should then be turned inside out. Do not attempt to do this if there is any sign of resistance or splitting. Instead the rough outer bark becomes the water side of the canoe.

The two ends are drawn together as closely as possible. A series of holes are then cut spaced between 15 cm and 30 cm from the ends with a sharp knife. They should be in a zigzag pattern. Vine or very tough bark strips or other strong material is laced through the holes. The lacing is then pulled tight to draw the ends together.

On the inside these ends are packed tight with clay to make them as watertight as possible. Softened eucalypt gum bleeds — if there is enough of it about — can also be used as a primary caulking before the clay is applied. This will make the canoe much more watertight. In fact any tree resin can be used, but collecting it is a laborious process.

Spreaders are required across the centre of the canoe to prevent the sides from collapsing inwards. To fit these, two pieces of split timber about 60 cm long and about 10 cm thick are cut. Holes are made in the bark near the canoe's centre of gravity. The spreaders are then lashed to the sides with vine or other material.

The spreaders are nicked in the centre. A spreader stick — simply a straight and suitable piece of wood — is braced in these grooves.

Paddles can be shaped out of any convenient dead timber which can be carved into the usual shape.

This type of bark canoe must be kept in the water at all

times. If it is taken out and then dries out on a bank it will usually split. These canoes have relatively short lives and they must be handled delicately.

A few health tips

Proper care of the feet is paramount in bushwalking. It takes almost no time for a small blister to turn into an ugly, bleeding wound, making progress almost impossible.

If your feet show signs of becoming tender they can be hardened by rubbing them with methylated spirits. In an emergency urine also helps.

Sticking plaster offers immediate protection and should be applied as soon as a raw spot is noticed, even if a blister has not formed. The best treatment for a blister when it has formed is to thread a piece of cotton through the blister. Cut off the thread on either side of the blister. This will allow the fluid to drain away but prevent air (and thus infection) from entering. Cover the blister with sticking plaster.

Ingrowing toenails are another cause of foot trouble. Immediate relief can be obtained by scraping the top of the toenail, either with a knife or a file, or even a piece of broken glass. The top of the nail should be scraped until it is sufficiently thin to be easily depressed with the tip of one's finger.

Corns, of course, can be pared down but a reputable corn plaster is best. Avoid wearing tight-fitting boots.

In rocky country twisted ankles are a common ailment.

If the ankle has not been too severely twisted the best thing is to keep on the move, gradually letting the ankle get back into working order. You will be able to keep going as long as the ankle is warm. This at least will enable you to make camp for the night. You will find that once you stop and you cool down, the ankle will stiffen. Walking may be difficult or impossible the next day. In this case rest is the only cure. With a slight sprain you should be able to continue after a day's rest, albeit slowly.

If the twist is severe stop immediately. The ankle should then be bathed alternately in very hot water and then very

cold water. This should bring some relief. A very tight bandage should be applied and the whole foot kept warm. Once again, after a day's rest (assuming this is a walk of some duration) you should be able to travel slowly.

When walking along river courses do not remove your boots. Most river beds are stony and frequently slippery with algae and other slimy growth. The water-rounded stones can also bruise the soles of your feet, making progress painful for the rest of the journey.

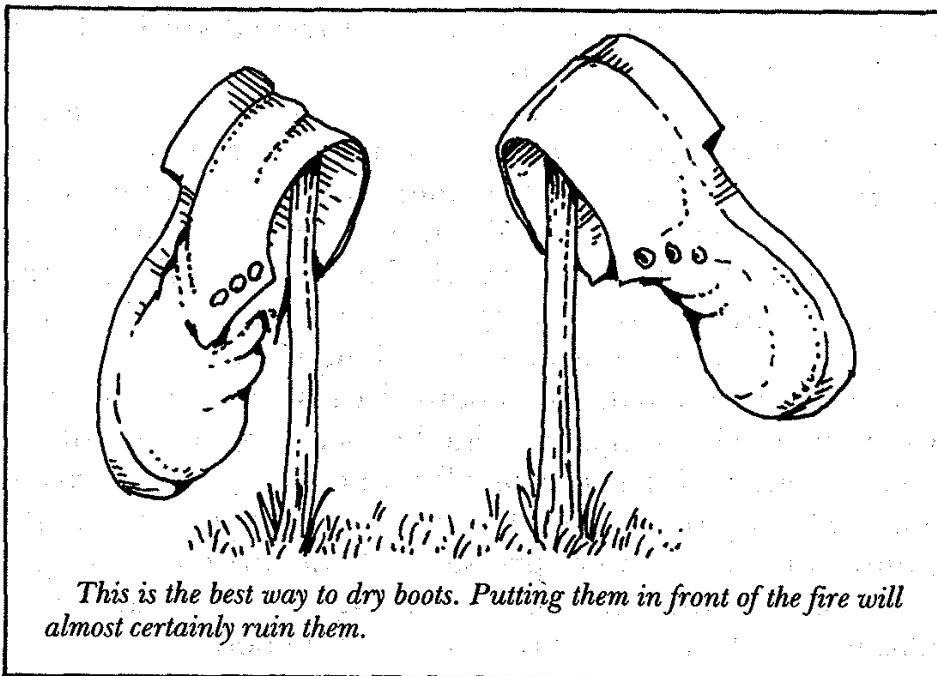

Water will not damage your boots, but drying them out by a hot fire will. If you want to drain them, drive two stakes into the ground and 'hang' the boots on these improvised trees. The boots will be damp the next day but they will be supple. A hot fire causes boots to shrink and crack out of shape. It also drives out the natural oils in the leather.

If your boots become too severely damaged to use, you can walk barefoot on grass or sandy earth. But stony surfaces will soon cut your feet to pieces. Improvised mocassins can be made by strapping thick pieces of fibrous bark to the soles of your feet.

The important thing is to thoroughly test a new pair of boots on short trips before undertaking a long tramp. More hikers have been crippled by new boots than by sprains. There is a tendency also for the novice walker to select an extremely heavy pair of bush boots. In most cases this is simply not necessary. Lightweight boots are perfectly suitable for all but the most rugged country.

BUSH REMEDY FOR STOMACH AND BOWEL UPSETS A very simple remedy for many abdominal and bowel upsets is to chew and swallow a piece of charcoal every two or three hours. A lump about the size of a 10 cent coin should give some relief if it is a gastric upset. Not so many years ago charcoal biscuits were one of the standard prescribed remedies for bowel troubles.

A frequent cause of stomach ache and loose bowels is the drinking of cold water or other fluid when the walker is very hot and tired. It is a good precaution under these circumstances to drink slowly and drink only tepid water.

CARE OF THE EYES Nature has provided your eyes with a most effective germ killer — your tears. A tear will kill most bacteria and also acts as an eyewash.

Despite this natural protection your eyes may suffer from glare or be irritated by dust or sand. To break the glare tie a strip of dark material or bark across your face just below your eyes. This will break the glare from the ground and give at least some relief.

Dust can be simply removed by frequently dousing the affected eye with lukewarm water.

CLEANLINESS AND FOOD Cleanliness of eating utensils is very important. These should be washed immediately after a meal and left exposed in the sunlight for as long as possible.

If there is any doubt about your fresh meat being safe to eat, assume it has gone bad rather than take the chance. The safest way to carry meat is to partially cook it before taking it on your journey. Cooking will destroy the bacteria that cause

decay for a short time. Items such as sausages are best cooked fully before you leave home, carried in their cooking fat, and then reheated.

Butter can be carried in the hottest weather if packed in a container in the middle of a bag of flour. This acts as an insulator.

CAMP TOILETS AND HYGIENE If you are camped away from civilisation and unless your party is extremely large, there should be no need to worry about an 'official' camp toilet or latrine. A hole in the ground is as good a place as any and as long as human waste is buried immediately it will not attract flies. It will also break down reasonably quickly.

For longer stays in a bush environment it might be necessary to designate an official toilet area. In this case a pit about a metre or slightly more deep with a log surround might be felt necessary. The soil from this pit should be piled on the side and after every use some of it, plus a little bush litter (leaf mould and other material) should be placed in it. It should also be covered with sheets of bark or brush branches, once again to keep out flies.

If travelling in a vehicle where such things are easier to carry, there are certain chemical compounds sold in powder form which are claimed to keep such a pit 'sweet'. However, a small sack of garden lime will do just as well and it costs next to nothing. Neither the powder nor the lime is essential as long as the rules of keeping the pit covered and smothering waste matter with bush mould and dry leaves is adhered to.

The pit should not be sited near a watercourse, drinking hole or spring. One knows that animals pollute in an absent-minded way. There is no need for campers to add to this water pollution problem.

Bushwalking with a vehicle

Bushwalking with a vehicle, whether it is conventional or a four-wheel drive, is now probably the way that most people

get at least a taste of the bush. It is, of course, bushwalking in more than modest luxury.

Elsewhere in the book reference has been made to a number of small luxuries that can be taken on any camping trip by the party that does not have to carry everything on its back. Apart from other things they include large portable gas or fuel stoves, which obviate the necessity of gathering firewood at any meal stop, air beds, large tents, a variety of cooking equipment, including reflector ovens, refrigerators and coolboxes, chairs and tables and in fact almost anything that one would care to name.

In deciding what to take the general load should be taken into consideration, especially where fuel consumption is concerned. The vehicle bushwalker can, in fact, travel as sparsely as the person on foot and suffer no real discomfort. Thus, before packing the kitchen sink, think whether it is absolutely necessary.

This can be quite crucial when travelling in sparsely populated areas of the 'real' outback where fuel stops are few and far between and where extra petrol and water has to be carried in jerricans as a matter of course. The swagman tradition has long since died in the interior. And even then the swagman was easier to cope with. All he wanted was some tea, sugar and a bit of meat. The squatter could always let the swaggie go out and kill an old ewe. The problem is somewhat more difficult to solve when that same squatter's grandson is confronted with a travelling party that is out of petrol. His own store may be low and it is impossible to give the traveller a killing knife and tell him to find a petrol ewe in the back hundred (or ten thousand, as the case may be).

For any extended vehicle travel in the bush, much as the walker should ensure that his boots are not falling apart, so the driver should make sure that his vehicle is sound.

Apart from the spare parts and a repair kit, it should also have a fire extinguisher, jerricans for water and extra fuel, a high lift jack, a steel tow rope, jumper leads, an 'instant' wrap-around plastic windshield, a spade or entrenching tool and an axe or machete for good measure.

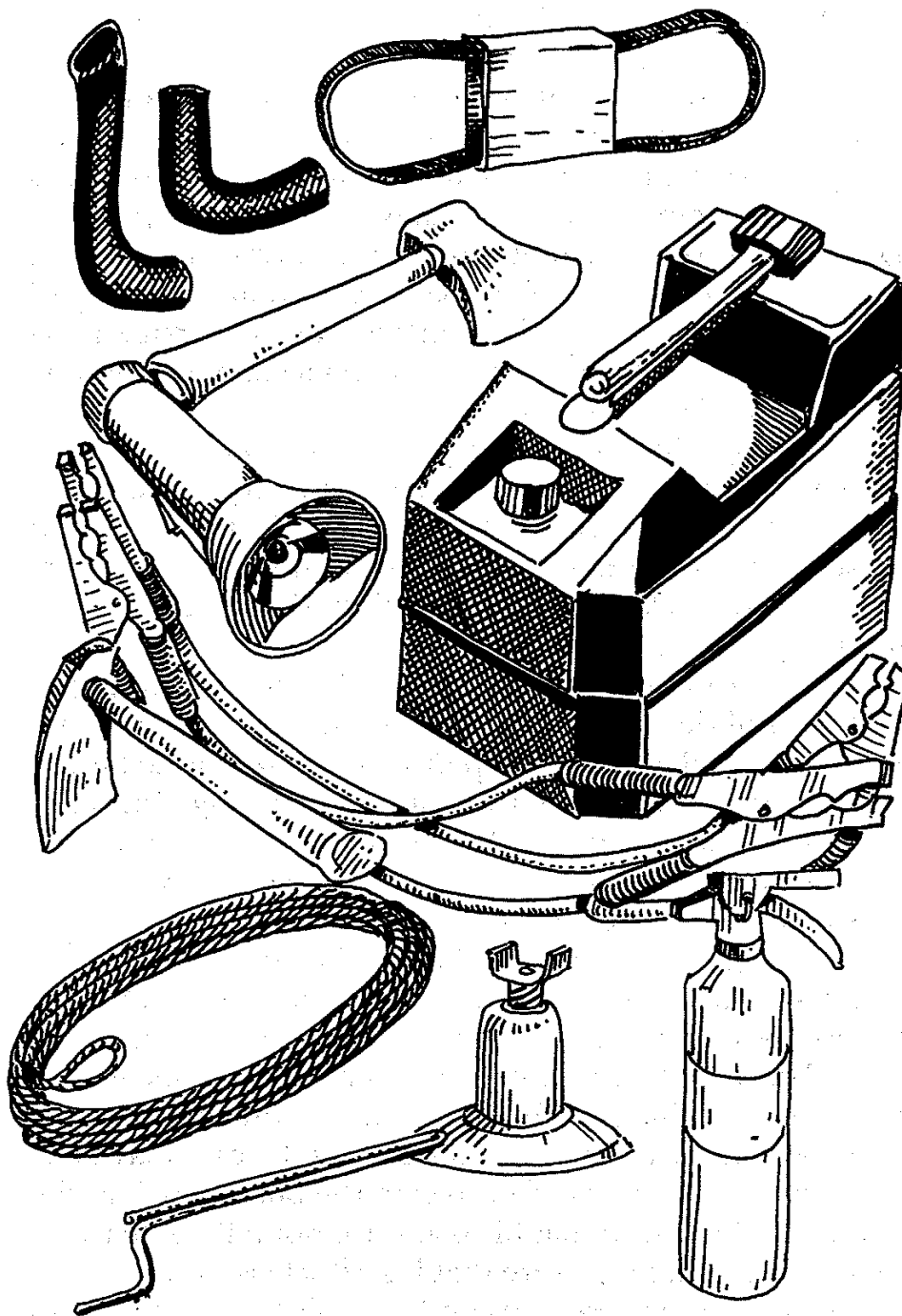

Some of the essential equipment needed when taking a vehicle into the bush: spare hoses and fan belt, axe, torch, metal jerrican, jumper leads, muttock, steel tow rope, jack and fire extinguisher.

Then comes the normal camping gear as well.

Two items that can be fitted to the vehicle are very much a matter of personal choice. They are a mesh windscreen protector, which is useful if driving almost constantly over unsealed roads, and 'roo bars. The 'roo bars are not really necessary for most driving situations and they send the petrol consumption up because of their weight, but they seem to give some drivers a feeling of security. If that sense of security outweighs the worry about petrol consumption, by all means fit them. It should be remembered that most of the larger kangaroos and wallabies are encountered only at dawn and dusk. By not driving at these times of day you can dispense with the bars.

If fitting a roof rack, do not load all the heavy equipment on it. This will throw the vehicle's centre of gravity out of balance. Fuel and water containers are best kept low down with the lighter goods on top.

Despite the fact that they are not walking, car travellers will also find it convenient to stow their gear in packs. Packs are far easier to manhandle around a campsite than duffel bags or suitcases and are built to take hard knocks and general bush roughness. Anyway a couple of small ones are essential to carry lunches and other gear on the inevitable half-day ramble without the car.

In coastal and semi-inland areas the driver will not encounter any hazards not found under normal 'home' conditions, but once further inland matters can change.

One of the hazards frequently encountered, especially in dry years, is that of travelling stock. Although on main roads drovers are required by law in some States to indicate they have animals along the road (much in the same manner as the 'Workers ahead' signs), either they don't bother or, if they do, they simply put up makeshift signs and abandon them. Thus the sign, written in spray paint, stating 'Travelling stock ahead' can mean anything or nothing. It is always best to be cautious and assume that there are animals – and a large number of them – in front of you rather than decide that the notice is long forgotten.



When driving through animals which are coming towards you, use a low gear and drive slowly. Do not sound the horn.

The best thing to do is to slow down. If the flock or herd is coming towards you the animals will normally part and you can proceed in low gear. Do not sound your horn as this will usually create complete pandemonium. If the animals are travelling in the same direction as you are, progress will be slower because they simply will not part. It may take half an hour or more to get through a large mob that is going your way.

In the outback, stray cattle are one of the greatest hazards. They are large, slow moving and very difficult to see in the dark. For this reason alone, night driving in the outback should be avoided wherever possible.

In the bird world magpies and galahs will give you the greatest trouble. Most other Australian birds, if feeding on the road, will veer away from an oncoming vehicle. For some unknown reason magpies and galahs do not, often crashing into your windscreen. In this case use the horn. This usually gets rid of them.

This fact about both birds has been confirmed by NSW Parks and Wildlife officers who have stated that neither species ever has seemed to have developed any road sense.

Creek crossings also need caution. It is always wise to stop and inspect the depth of water at a crossing — even if it has a built-in cement dip. If in any doubt walk it first. It is extremely hard to judge the depth of water simply by looking at it and it is better to be sure than stuck.

If the crossing appears to be safe use low gear and keep the motor running. And like the bushwalker on foot, don't hesitate or panic halfway across. Keep going. On long crossings it may be wise to disconnect the fan belt to prevent damage to electrical equipment.

Most non-sealed roads in the inland quickly turn into quagmires after heavy rain. This can occur after as little as 25mm in half a day. The only thing to do is to stop and wait for the country to dry out. If the rain is particularly bad, attempt to make for rising ground to at least give yourselves a half-comfortable campsite for the night. If you have spare food and water and a portable stove you will come to little

harm. If this 'flat flooding', as it can be called, is bad you may have a lot of native hangers on for the night, including lizards and snakes and probably the odd cow or two. Try to treat them all with consideration. They don't like it much either.

At the opposite extreme is the dust storm. These can be expected in drought years but can also be quite localised in even good years (after heavy broadacre ploughing, for instance). Stop the vehicle and sit it out. Visibility can be poor to hopeless. Besides which there can be large drifts across the roadway which make driving impossible.

Right in the interior a speciality known as bulldust will become known to you. This is as fine as any face powder. Not only does it blind you as it rises and seeps through the vehicle, but like sand it can completely obscure any potholes in the road surface. It should be tackled very slowly and cautiously. This way if you hit a deep pothole you are unlikely to damage your car.

To end on a wet note, boggy roads also require caution and low speeds. If your vehicle does get stuck the only way

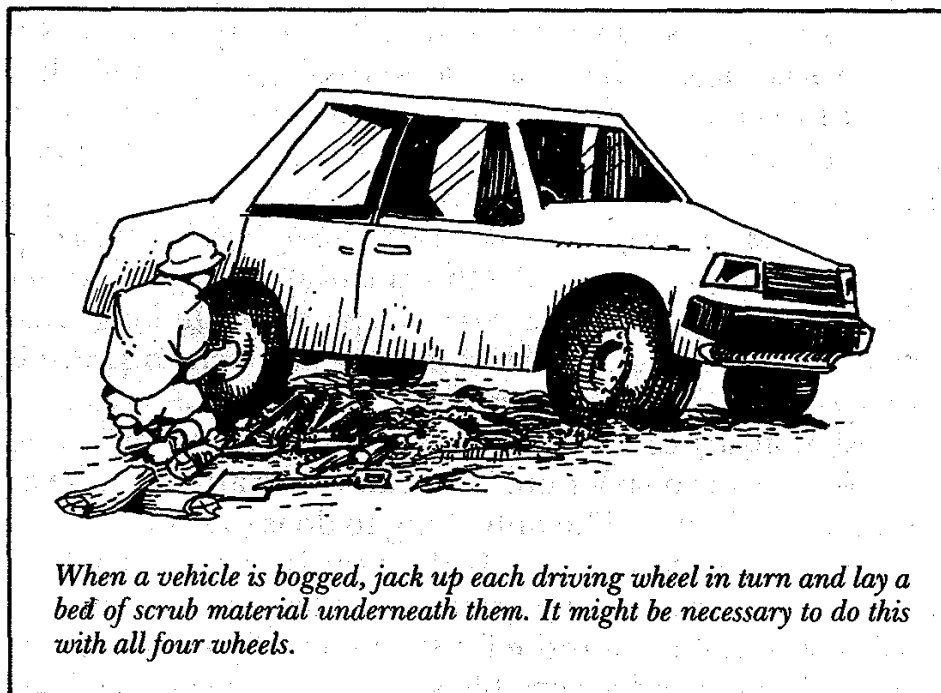

When a vehicle is bogged, jack up each driving wheel in turn and lay a bed of scrub material underneath them. It might be necessary to do this with all four wheels.

to get it moving again is to dig it out. If necessary jack up each drive wheel one at a time, and place a bed of any dry scrub material underneath it. Try to make a road out of brush in fact, after the wheels have been 'brushed up'. If no brush is available use branches or stones. Move the car very slowly in low gear with everyone else lending a helping hand on the outside.

This method is no different to that used by coach drivers to get their carriages over blacksoil plains — in other words, everyone out and push. Instead of horses straining, you have your engine. It doesn't always work, one should add. In fact the best advice is not to enter boggy territory at all.

Road trains are another hazard. They can be up to 50 metres long so do not be in a hurry to overtake them. They are capable of travelling at a good speed and it is often safer to follow them, keeping well behind to avoid the dust and turbulence. When one is approaching, it is customary for a smaller vehicle to pull over to give the road train full use of the bitumen or the formed track.

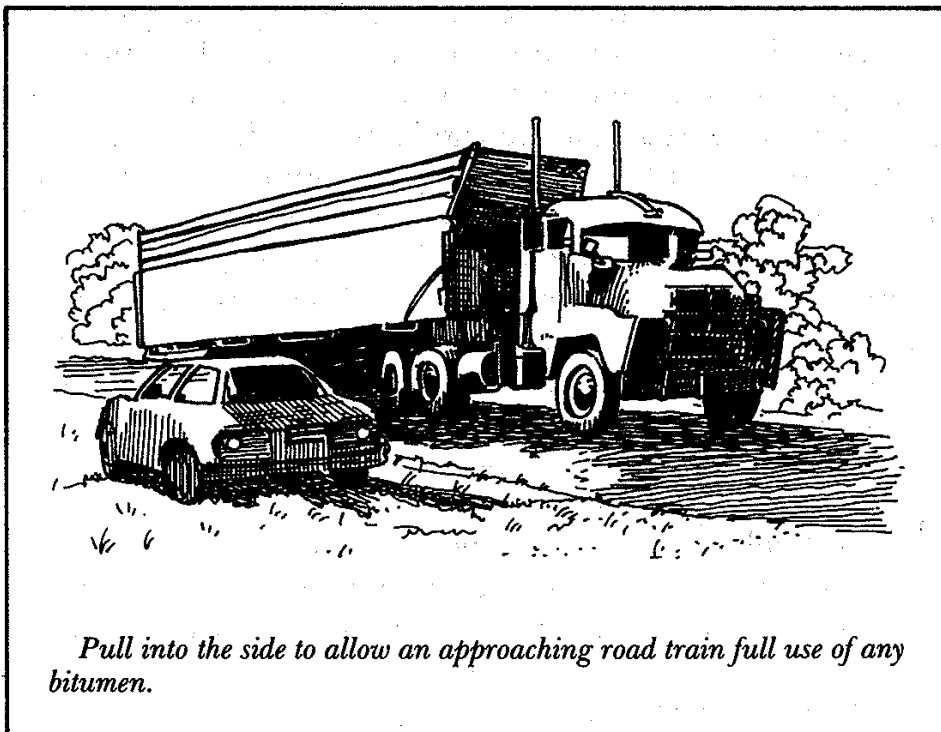

Camp Sun Clock

Select a patch of bare earth near the camp. It must be level and open to the sun all day. Stick a peg in the centre of this patch and, with a length of cord as a loop around the peg, scratch a circle on the ground.

This must be at least 1.5 metres across. From the peg, which is now the centre of the circle, carefully draw a line true north. This must be accurately true north and not magnetic north. Extend this line to cut the southern side of the circle, and then draw in accurate east-west lines crossing at the circle's centre.

Divide the circumference of the circle into 24 equal divisions. Each of these divisions will be 15° .

Now have a look at your map and find out what degree of latitude you are in. Measure this degree on the outside circle working from where it is cutting the east-west line. Put a peg on each side of the circle's edge to mark the latitude degrees.

Be careful to note whether your latitude is north or south of the equator. Stretch the cord over the two pegs and mark where it crosses the north-south line. Now put a peg on the north-south line where the cord crosses it. Next put two other pegs at either end of the east-west line so that the 'degree' pegs on the circle are at right angles. Tie a cord to each of these pegs and have the cord pass round the peg on the north-south line. Lift the cord over the centre peg and with the point of a knife scratch an ellipse on the ground so that it touches the circle where the east-west line crosses and also touches the point on the north-south line where the peg is.

Connect up the 15 degree marks on the circle by means of the cord.

Where the cord crosses the ellipse put a small peg very firmly into the ground.

There will be 13 of these pegs and they will follow the curve of the ellipse. These are the hour pegs, starting from 6 a.m. on the left, where the west line cuts the circle, 12 noon on the north-south line and 6 p.m. on the right where the east line cuts the circle.

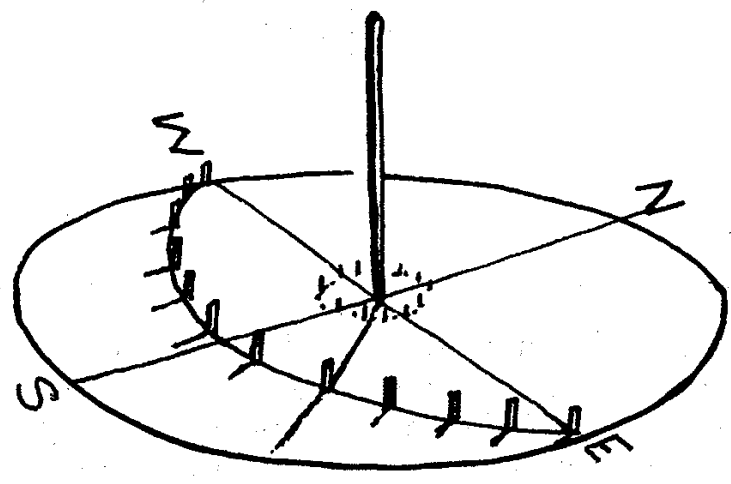
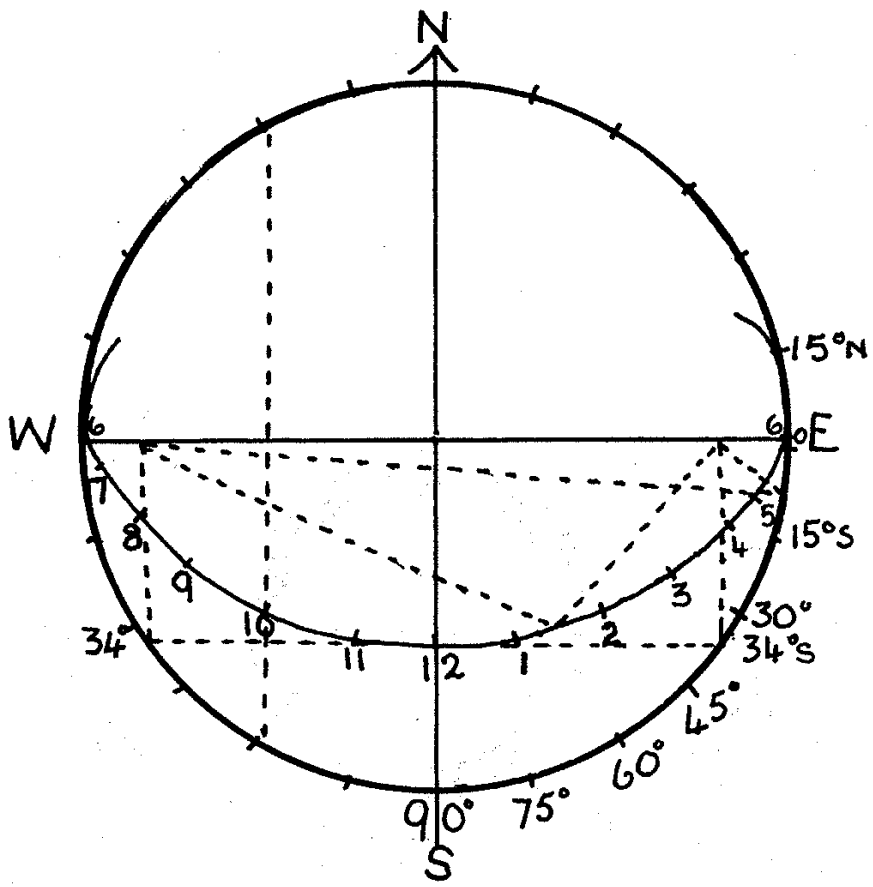

How to make a sun clock. Stage 1.

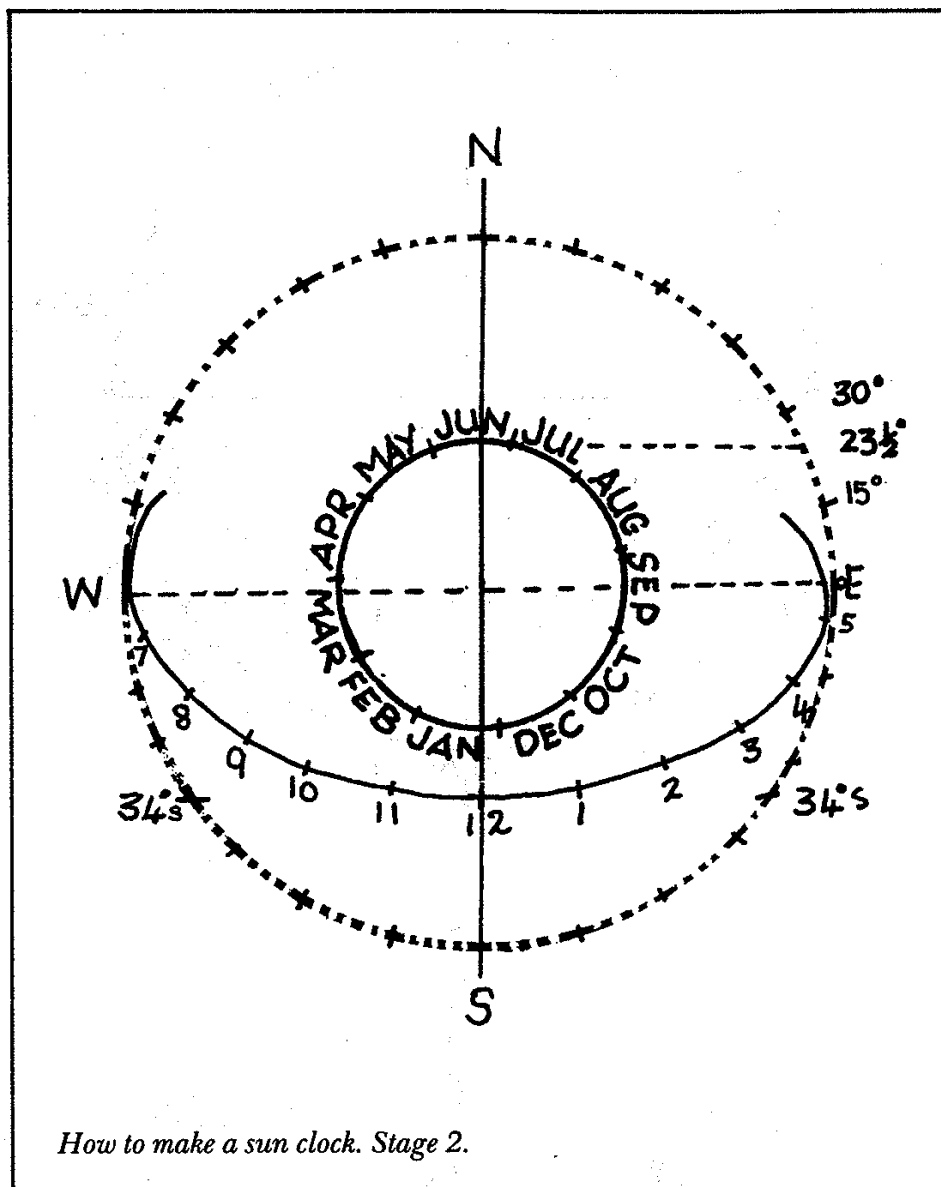

You then determine where to place the shadow stick. This depends on the sun's position north or south of the equator.

Draw another circle inside the big circle using the same centre. The radius of this circle must be equal to $23\frac{1}{2}$ degrees of the big one. Cut this inner circle into 12 equal divisions and mark June at the north side and follow on with July, August and so on clockwise. Then divide June into four equal divisions and do the same with December at the south

end. Offset all divisions one fourth in a clockwise direction. The north-south line will now pass through the third division of June and December. Put pegs in for each of the 12 month's divisions.

To find the sun's position at any time of the year draw a line from the month, and approximate day thereof, to the

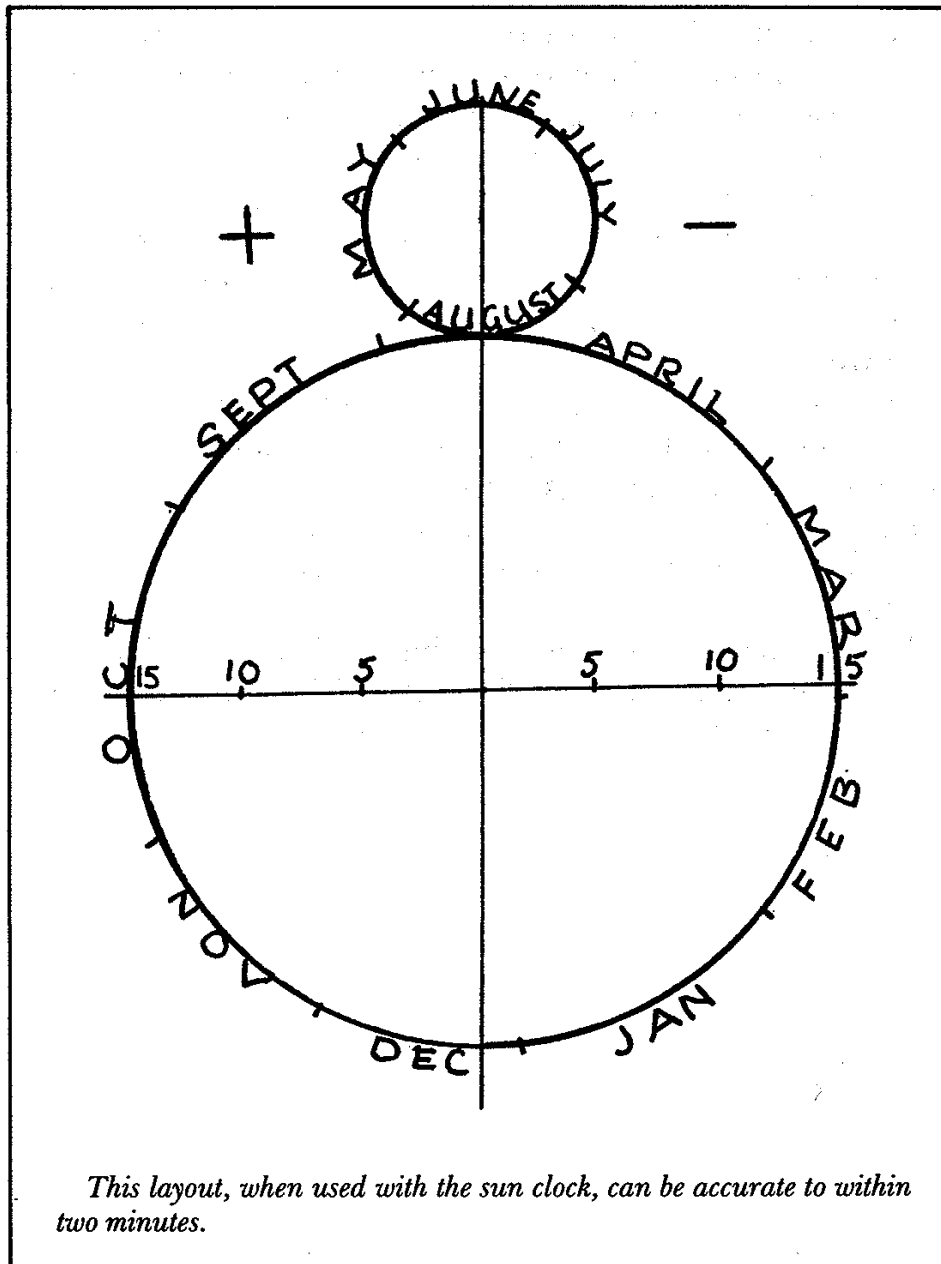

north-south line. This must parallel the east-west line. Where this line cuts the north-south line is where you place your shadow stick.

To get absolutely reliable time from the sun, two corrections for longitude and for the 'equation of time' are required (see page 302).

The 'shadow' reading with these corrections will be right to two minutes if your north-south line has been accurate.

If west of the meridian of standard time add four minutes to sun clock time for each degree. If east of the meridian deduct four minutes for each degree.

Draw a figure 8 near the sun clock on the ground with the top half of the '8' just less than one third of the size of the bottom half. Draw a line across the middle of the bottom half of the '8' and cut it into three equal divisions on each side of a centre line.

Each of these divisions represents five minutes of time.

Now mark off the figure '8' into approximate divisions (see illustration). Put pegs in the ground to mark these divisions and also the five-minute divisions on the cross line.

Put a *minus* sign on the right hand corner and a *plus* sign on the left.

Minus means that the sun time is behind clock time. Therefore you must add. Plus means that the sun time is ahead of clock time.

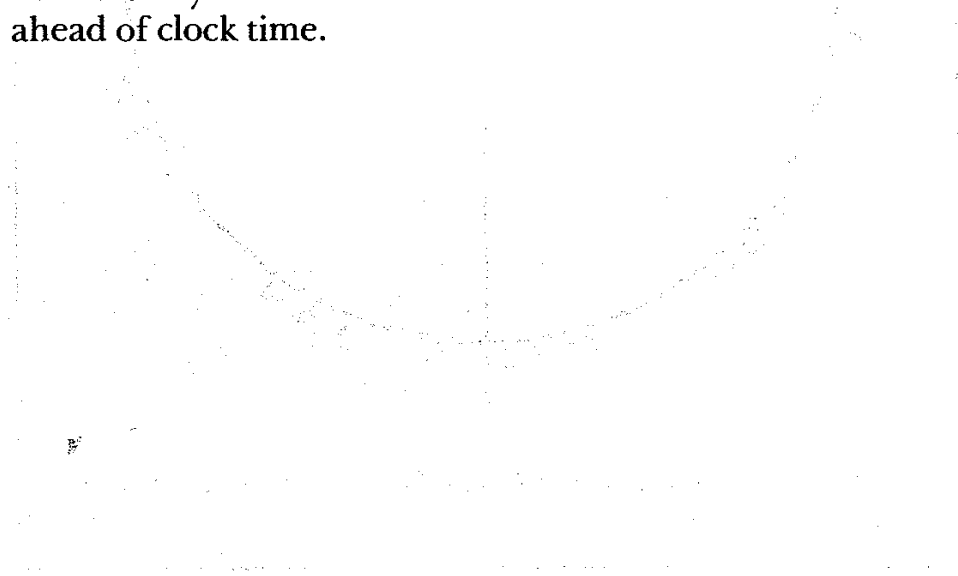

5 Food and Water

Although it is assumed that every bush traveller will carry his or her food into the wilderness areas and will ensure that the supply is adequate, identifying plants that are edible is interesting as well as being an on-the-ground lesson in botany.

The Aborigines made use of thousands of wild plants both for food and for medicine. These have been mostly forgotten as the white settlers preferred to bring their known food plants from the Old World with them. Except in an emergency none of the native plant sources should be relied on to supplement the diet.

However the sea and the surrounding shore still offers a wealth of edible material for the coastal walker and traveller. If one were attempting a 'living off the land' experiment this would be the area of Australia to pick. Things would still be difficult but one would be hardly likely to starve.

This chapter also indicates where it is possible to find water in emergencies. But the traveller, as has been stressed earlier, should make sure that the party's supplies are adequate before entering unknown country.

Anyone planning a walking holiday in the bush should carefully plan out the daily food requirements and include something extra for emergencies. With the wide and increasing range of freeze dried and naturally dried foodstuffs now available there is no excuse for scanty provisioning.

The walker should under no circumstances expect to live off the land. The tribal Aborigines had this skill but even the early European explorers had little or no ability, once the

lushness of the seaboard areas of the continent were left behind, to survive with any degree of certainty.

Added to this, outside of certain introduced animals classified as vermin, such as the rabbit and the feral pig, almost all native species are completely protected. And in national parks and wildlife reserves the flora is totally protected as well.

However, in emergencies, it may be necessary to stretch out one's hiking rations or live off the land to some degree. In this regard some knowledge of the edible properties of various plants and animals is useful.

Although the seashores of the continent provide the richest gathering grounds for the hiker wanting to supplement his or her diet, inland waters can also be extremely productive. So no matter where you walk always pack a fishing line and a few hooks and lures. They weigh next to nothing and you might just be grateful that you took the trouble to throw them into your pack at the last minute.

As most people know, not everything on the face of the earth was put there for human consumption. Many plants are highly poisonous, others can be eaten only after extensive treatment (the most usual being the action of water leaching out alkaloids).

The flesh of some fish is also toxic. Once again, as a general rule the flesh of all land animals, on the other hand, is edible. It may not be palatable or even pleasant but it will sustain life.

All wild land animals on the other hand can be infested with parasites either as worms or eggs. Mature feral pigs are invariably very badly worm-ridden. Thus all meat should be extremely well cooked to avoid infestation. The quickest way to achieve this is to cut all wild meat in extremely thin strips, and cook it at as high a temperature as is possible. The parasites will not survive this treatment.

Methods of food preservation

All methods of preserving food are aimed at preventing it

from being destroyed by bacterial action — ie., rotting. Two age-old methods are sun and wind drying and salting or pickling. Unless one is travelling by vehicle where extra salt can be carried without any inconvenience, this method cannot be used by the bushwalker.

And unless the party is on a snow expedition the now standard household method of freezing is of no value, although quite obviously it can be made use of under these circumstances.

Thus the best ways of keeping wild animal food fresh under bush conditions are sun drying or smoking, or a combination of both methods.

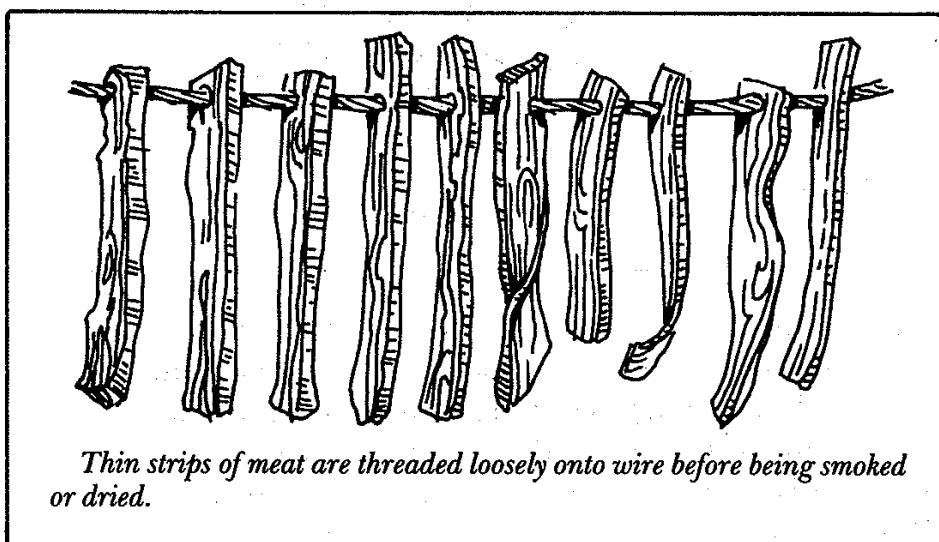

SUN DRYING OR SMOKING The meat to be smoked or sun dried must be freshly killed. Cut off the fatty portions and use them immediately — the meat to be treated should be as lean as possible.

Then slice it into strips no thicker than 1 cm and about 3 cm or less wide. The strips are threaded on to a wire or cane. They must not touch one another. The air must be able to circulate freely between the strips.

Hang the canes or wires holding the meat strips above the thin blue smoke of a wood fire until the outer surface is quite dry. Depending on the air temperature this may take from

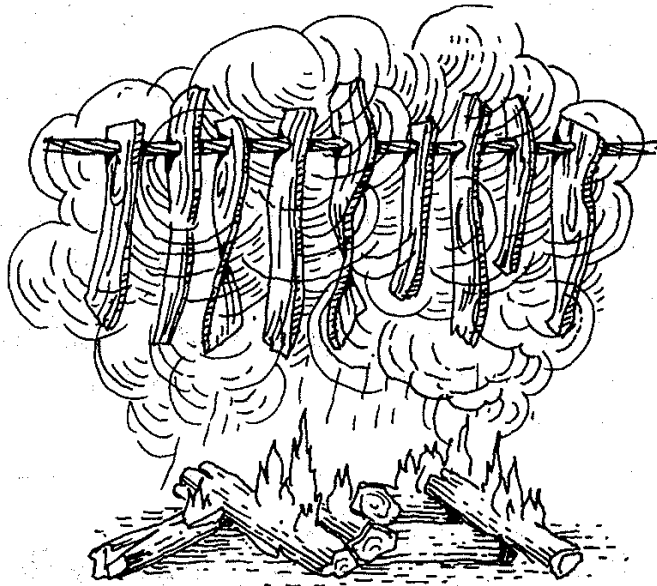

Smoking meat over a fire. The fire should provide smoke, not cooking heat.

one hour to a day. Do not hang the meat too close to the surface of the fire or anywhere close to the actual flames, otherwise it will scorch and cook. If cooked it will not keep.

If the meat is to be sun dried the only reason for this initial smoking is to protect the fresh cut moist surface from flies. Blowflies will not lay their eggs on a dry surface.

The fire should give off just enough smoke to keep these flies away. Do not pile on green leaves or other wet material on the assumption that the more smoke there is the better the meat will cure. Moisture and oils from wet material will condense on the surface of the strips rendering the meat inedible.

After removing the meat strips from the smoke, remembering that the surface must feel quite dry to the touch, hang the wire or stick up in an airy sunny position. Under normal conditions it should be quite dry and hard after this treatment.

When carrying dried meat pack it in an open mesh bag.

Do not pack it in plastic wrapping of any kind. If it is completely enclosed it will sweat and go mouldy.

Sun dried meat, if properly prepared, will keep indefinitely, retaining all its food value. It can be eaten as it is — ie. raw — or cooked in stews. If it is to be cooked it should be soaked for about an hour beforehand.

Thin fillets of fish can be dried in the same manner as meat. With fish it is essential that the drying process be fast. If the day is cool smoke the fillets thoroughly over a fire.

If the flesh is flaky and the fish will not fillet without breaking up, heat smooth flat stones until they are quite warm but not hot to the touch.

Lay the pieces of fish on these stones and place in the sun to complete the drying process.

PRESERVING IN FAT If the weather is reasonably cool meat can be preserved for a few days by sealing it in its own rendered fat. The meat should not be hard fried, rather it should be gently simmered in the fat until it is thoroughly cooked. It is then lifted out of the fat and packed into a billy or other container that will hold it. Pour the fat over the pieces of meat and allow it to set hard.

When covering the meat with its own fat care must be taken that no gravy from the cooking be introduced into the storage container as this will go rancid quite quickly. Before packing the meat test to see that it is thoroughly cooked by pricking it with a knife. If it shows red it cannot be preserved and the cooking process must be continued until no blood shows on testing.

This method will work only if the fat sets completely solid. If the temperature rises suddenly and the sealing fat becomes liquid the meat preserved in this manner must be used immediately.

BRINING As stated earlier brining or pickling is not much use to the bushwalker who is carrying everything on his or her back. But it is of use in a permanent camp or where one is travelling by vehicle.

Modern brines or pickles are not intended to preserve meat for any length of time. But the pickles in every-day use until about thirty years ago were designed to keep meat indefinitely.

As no one on any sort of camping trip is going to carry the kitchen scales with them a good tip to remember for making a hard pickle is that the solution is strong enough when a potato placed in the salt-water mix will float to the surface.

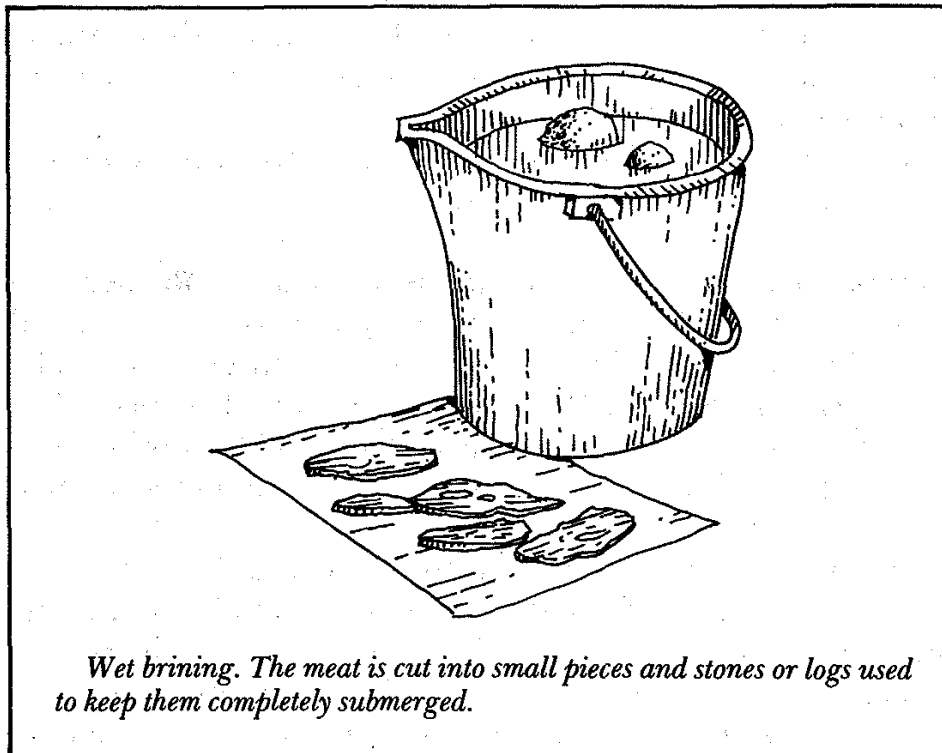

Commercial pickles contain saltpetre (potassium nitrate) in small quantities in addition to the salt. This gives the meat its red colour. Camp-salted meat, on the other hand, will be grey in colour — not butcher's shop red.

Complicated home brines also contain quantities of brown sugar and spices, but these ingredients are not necessary for emergency bush salting, although they improve the flavour of the meat when it is finally cooked.

When salting in an emergency remember to keep the meat in relatively small pieces — not more than about 1 kg

in weight. Even then if the meat is a thick chunk or contains bone, slide a sharp knife along the length of the bone or cut a pocket and rub dry salt into this cavity before inserting the piece in the liquid.

This prevents what is known in the commercial pickling world as 'bone stink' — decay, in other words.

In cool weather pieces of meat can be safely dry salted for a couple of days or longer by rubbing a thick crust over all surfaces and placing the pieces where they can drain. They should be rubbed and turned every day and protected from flies.

Wet salting or brining is far more hygienic because the brine itself prevents any insect strike. The pieces of meat must be fully submerged at all times in the brine. As they will float to the surface if just placed in the container they must be weighted down with a board or large flat stone.

Although salting was traditionally carried out in stone crocks a plastic basket makes a good container these days.

In the early days of European settlement, kangaroo and wallaby hams were highly regarded. Sometimes they were smoked after being brined for about a fortnight. On other occasions they were treated much in the same manner as pickled pork. Remember that all meat brined in this fashion is very salty. It should be well soaked in fresh water before cooking.

FREEZING As mentioned, this mainly applies to winter snow country treks, where small parcels of meat wrapped in plastic can be kept frozen solid for the duration of the entire camping period.

Much of the inland also has extremely cold winter nights, temperatures in some cases falling to -10°C . In these circumstances pieces of meat can be thoroughly chilled at night and kept thoroughly insulated during the day. In this way its 'freshness' can be extended up to three days. Thick layers of newspaper wrapped tightly around the meat make a fairly effective insulating bag. Lightweight soft plastic coolers can also be used for the same purpose.

Deep, cold pools or mountain streams can also act as natural refrigerators at a permanent campsite or during a one or two day stop. The meat, or any other material to be kept fresh, should be sealed in watertight containers which are weighted down in the water and attached to a strong rope line secured at the bank of the stream or pond. The container should also be vermin proof as eels, freshwater crayfish and yabbies will attack a flimsy container and damage or devour its contents.

Fish traps

Although the most usual method is by rod and line or a line around a cork or piece of wood most fishing communities over the centuries have devised a number of traps to catch fish, thus freeing people for other tasks during the day.

Whilst commercial netting is regarded as part of our normal activity, the trapping of fish by amateurs by any means is illegal in most areas.

Fish traps should only be used, therefore, when absolutely necessary as a means of survival and never, ever, as a means of recreation.

AUTOMATIC FISHERMAN A discarded blind roller is fixed to either a pole or a convenient branch of a tree. The fishing line is secured to the roller and then, with the roller pawl engaged, the line is pulled so that it touches the water or until the tension on the line is considered to be adequate. The roller is removed from the brackets and rewound by hand. This will give tension to the line to play the fish. The baited hook is lowered into the water. The pawls must be engaged to the brackets. When the fish strikes it will disengage the pawls and the tension of the wound up roller will play it, bringing it finally almost to the surface of the water.

The lazy fisherman then simply has to unhook the catch, rebait the line and set it for another fish.

In general, it is better to set the blind roller on to a pole which can be set horizontally above the water, and lashed to

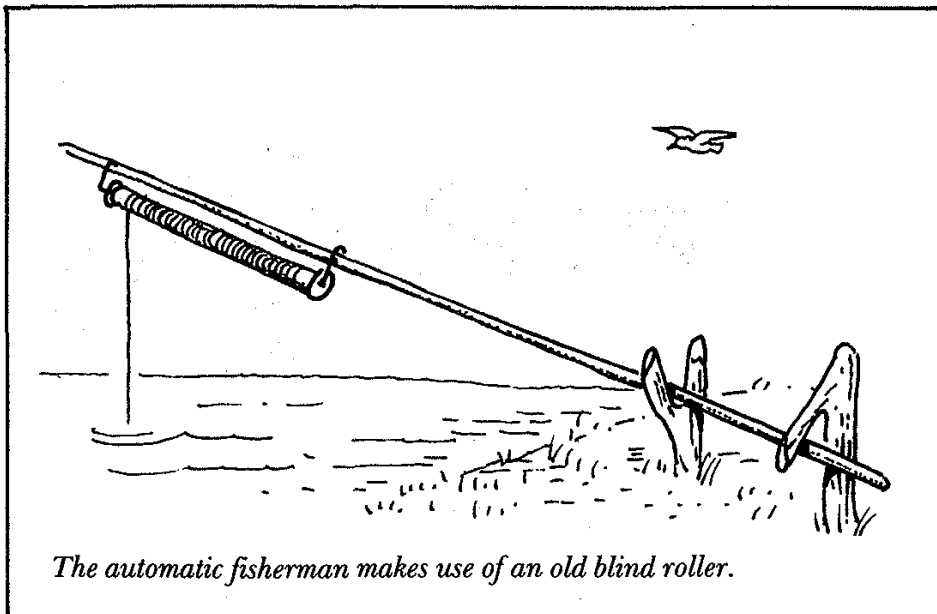

a convenient tree or stake, than to set it into a branch. It is much easier to remove the catch and reset the line if this method is followed. It is also far more convenient to try different areas of a river or creek by this method if the fishing is not good in a particular location.

TIDAL FISH TRAP This arrowhead fish trap is suitable for coastal areas where the difference between high and low tides is from 1-2 metres. It is a permanent trap and under ideal conditions will ensure a plentiful supply of fish in all seasons.

Select a site on an estuary or cove where the beach slopes fairly evenly. At this site run a fence of wire netting out at low tide so that the top of the fence will be about 10 cm above high water level and where the lower end will have 30-50 cm of water in it at low tide. From the low water end of the fence run back two wing fences each at an angle of about 45°. These two wing fences should come half way up to the high water level mark. From the shore end of these two wing fences run two more short fences parallel to the beach line and stopping with a turnback to the arrowhead about 2 metres short of the centre fence.

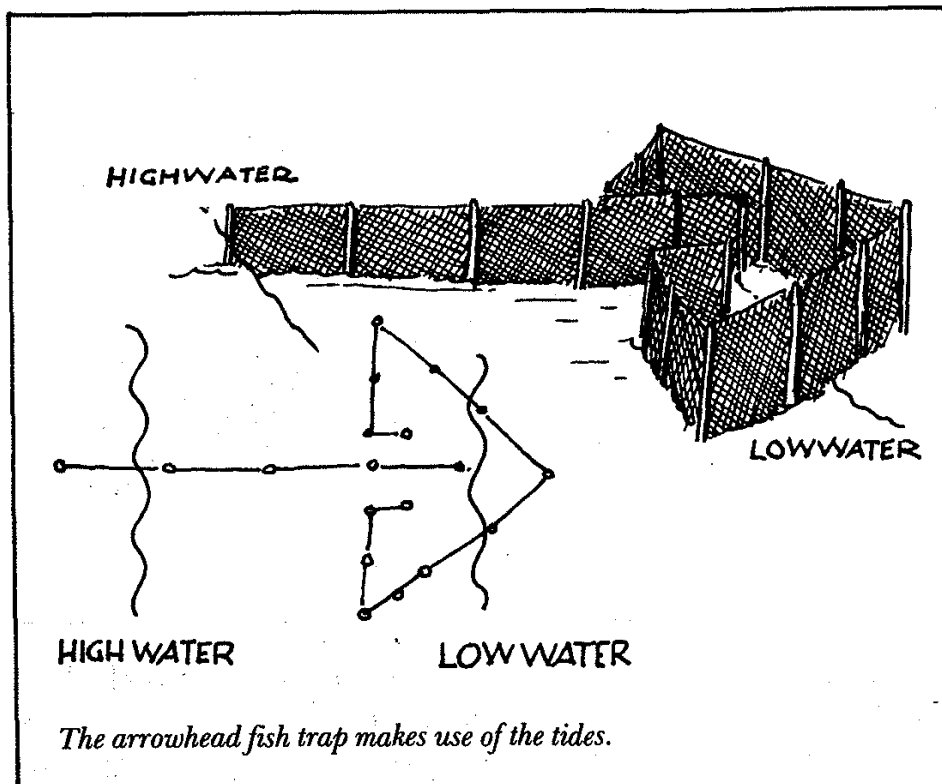

The fish will come into the beach on the rising tide and feed. When they come to the central fence they will turn along it into the deep water. The fence will turn them into the arrowhead.

The trap can be cleared at each low tide. You need only take the fish that you need. The others can be left alive in the trap. Some of those left will invariably find their way out to freedom at the next high tide but at least some will remain trapped.

TIDAL ROCKPOOL TRAP Select a site where there are a number of rockpools well covered at high tide. They should be barely dry at low tide.

Having selected the pool it should be heavily baited with crushed up shellfish, and small portions of freshly killed fish and crushed rock crabs. Across its normal opening a rock wall is built so that its top will be about 10 cm above the water surface at high tide.

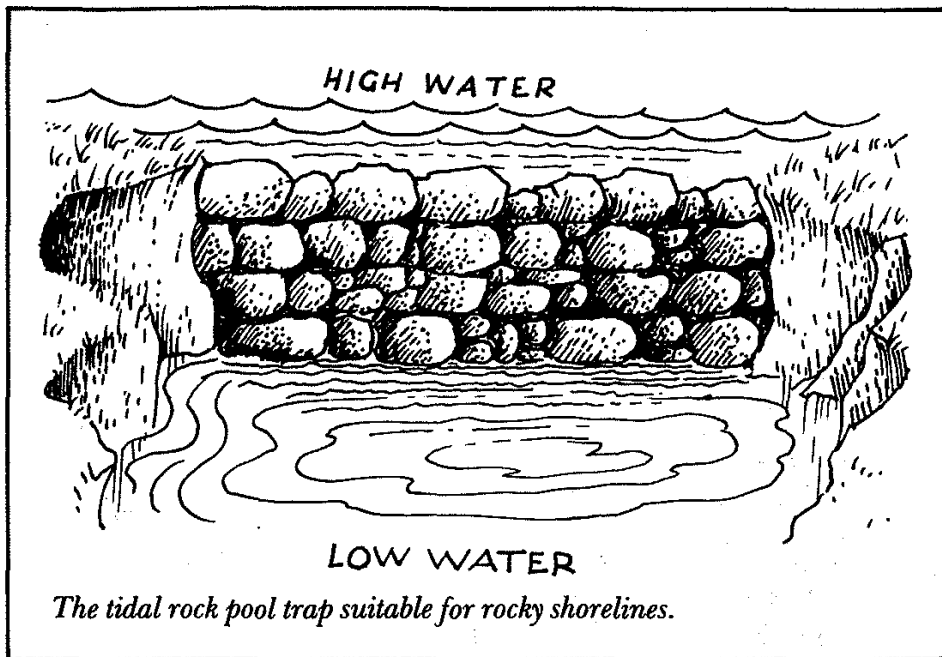

The fish, normally feeding at night during a high tide, come to the pool, drawn there by the baits lying on the bottom. With the fall of the tide they are trapped. The catch can be collected by hand or with a scoop net.

CRAB OR LOBSTER NET Make a circular wire hoop about a metre in diameter and sew a piece of fish netting or very thin sisal bagging around its edges so that it makes a loose basket.

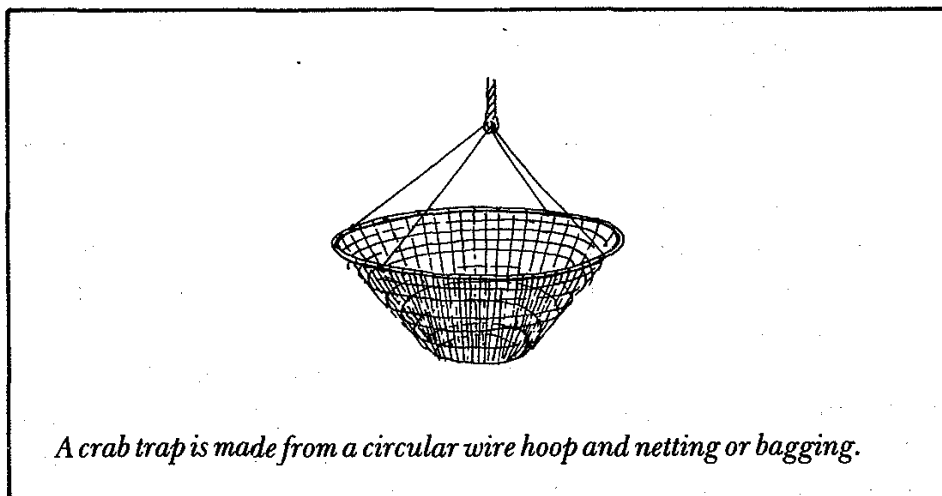

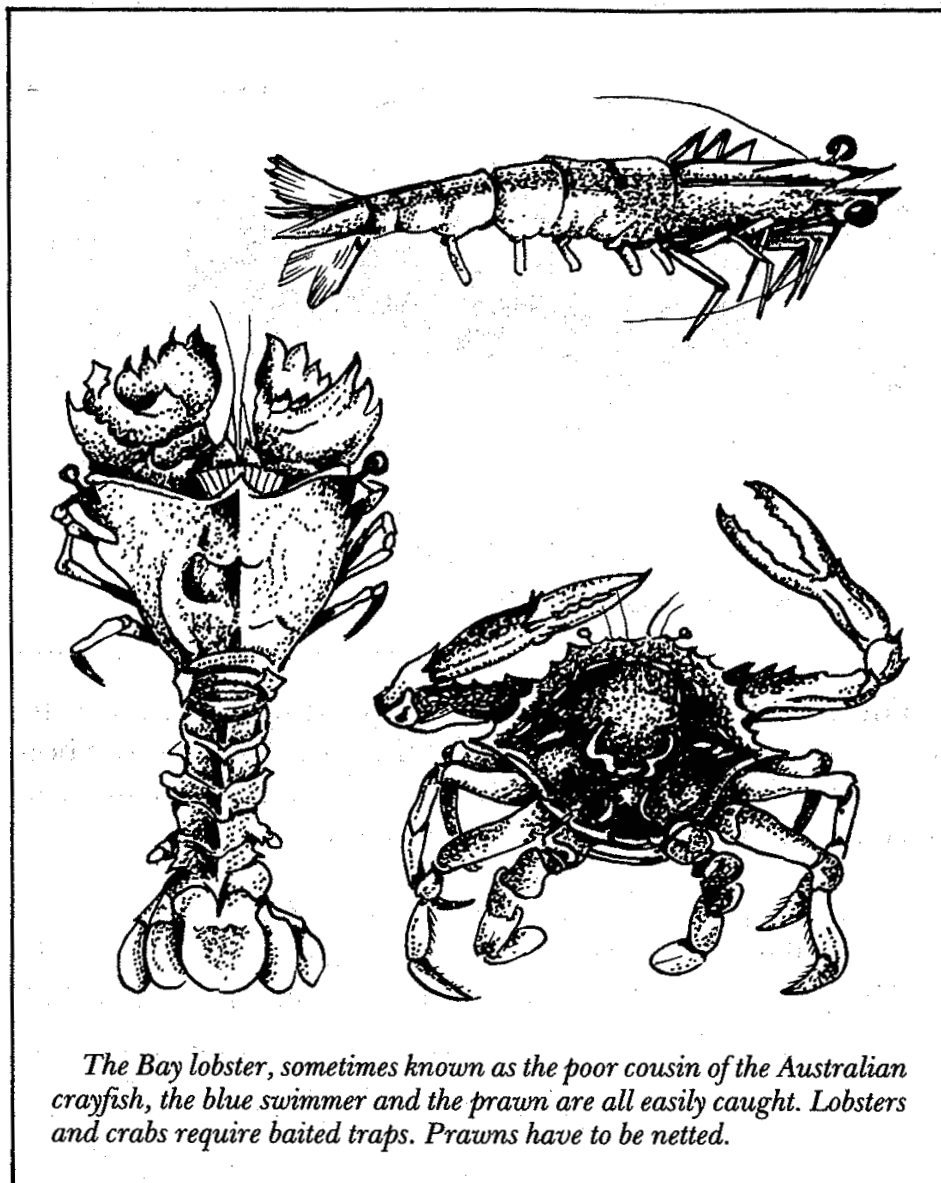

The Bay lobster, sometimes known as the poor cousin of the Australian crayfish, the blue swimmer and the prawn are all easily caught. Lobsters and crabs require baited traps. Prawns have to be netted.

Then tie three or four short lengths of rope to the hoop and join these together about a metre above the top of the hoop. These cords are then attached to a rope which can be buoyed or tied to a convenient post or rock, depending on the location of the trap. The bottom of the net is weighted with a rock and baited with a few fishheads or portions of small fish. These must be securely tied to the bottom of the net, otherwise the crabs will drag them away.

Meat can also be used as bait. It helps, whether using fish or meat, if the bait is decidedly high or rotten. Both crabs and crayfish have a decided preference for rotten meat.

The net is lowered into the sea and left undisturbed for about two hours. It should be pulled up swiftly. Any crabs or crayfish which have been feeding on the bait will be caught.

For crayfish set the net on a rocky, weedy bottom. For crabs it should be set on a sandy bottom, preferably not far from a reef.

DRUM NET FISH TRAP A drum net is simply a wire cage with an inverted cone-shaped entrance at either end. These cone 'doors' lead inwards and the fish swimming in through them are held securely inside the trap. A drum net can be set in mid-stream or dropped down into a deep river pool or laid anywhere where fish regularly feed — the edge of a seashore rocky ledge is an ideal place.

Almost any bait will do for this sort of trap; crushed shellfish, varieties of inedible fish or meat.

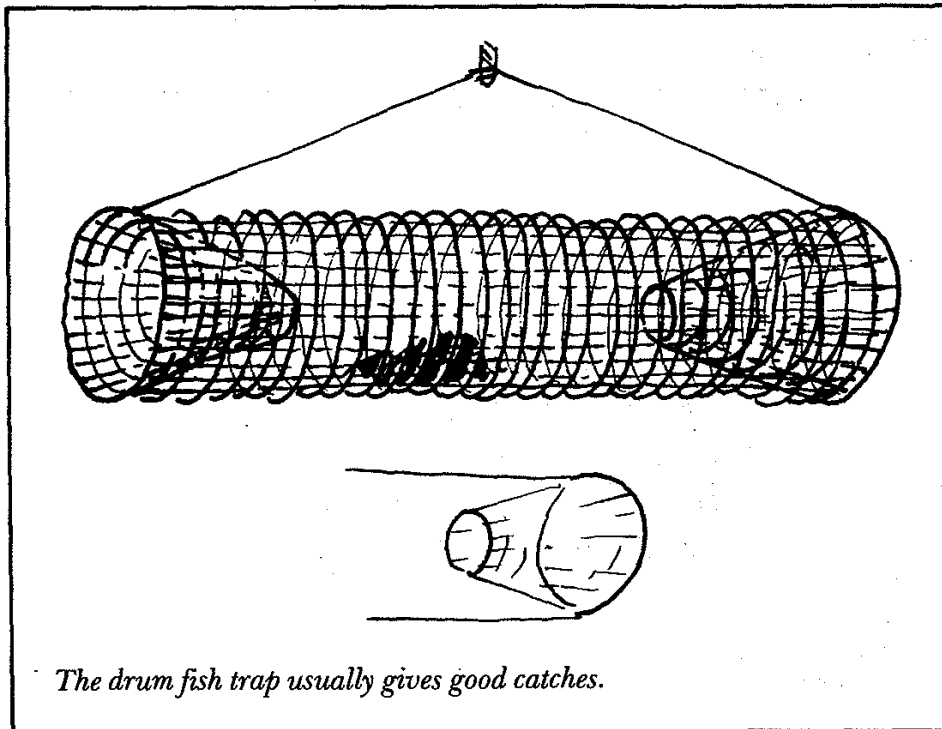

The bottom should be weighted with a couple of heavy stones. The net should be made with a mesh size large enough to allow the escape of very small fish which are no good for eating.

It should be inspected at least twice a day and the catch removed each time.

CRAYFISH OR YABBIE SNARE Make a circle out of heavy gauge wire. It should be between 30 and 50 cm in diameter. To keep it rigid two cross wires, out of equally heavy gauge material, are braced to it. Around this circle tie a series of running nooses. These nooses need be no more than 5 cm in diameter. Heavy nylon fishing line is excellent for this purpose. They should be tied to the wire circle about 3-4 cm apart.

The bait for this trap is tied in the centre where the supporting cross wires bisect each other. Three or four cords are then tied to the circle wire and a rope affixed to them.

A couple of small stones may need to be tied to the circle as well to provide enough weight to get it to set firmly on the bottom.

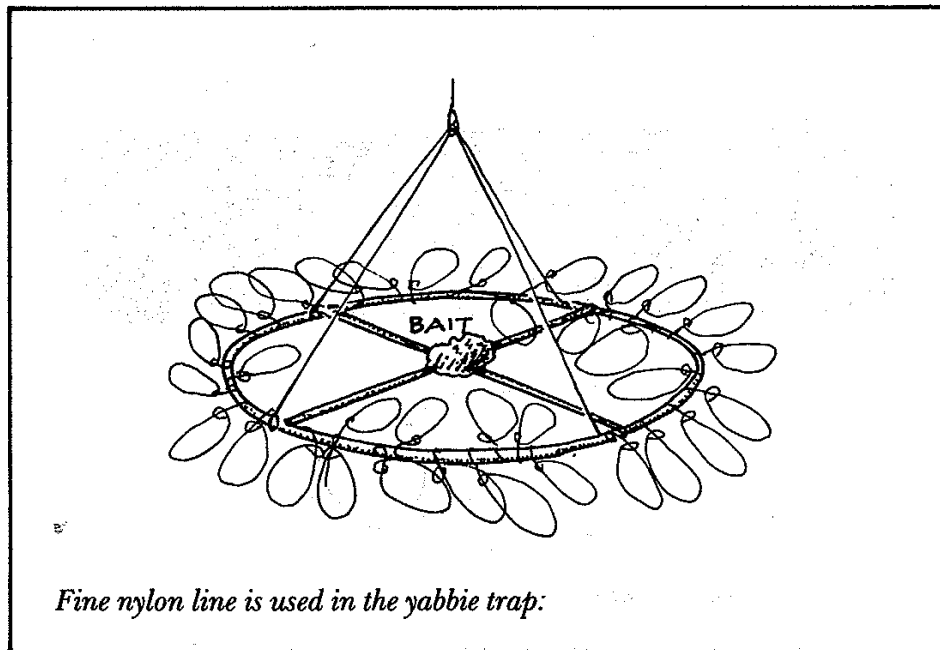

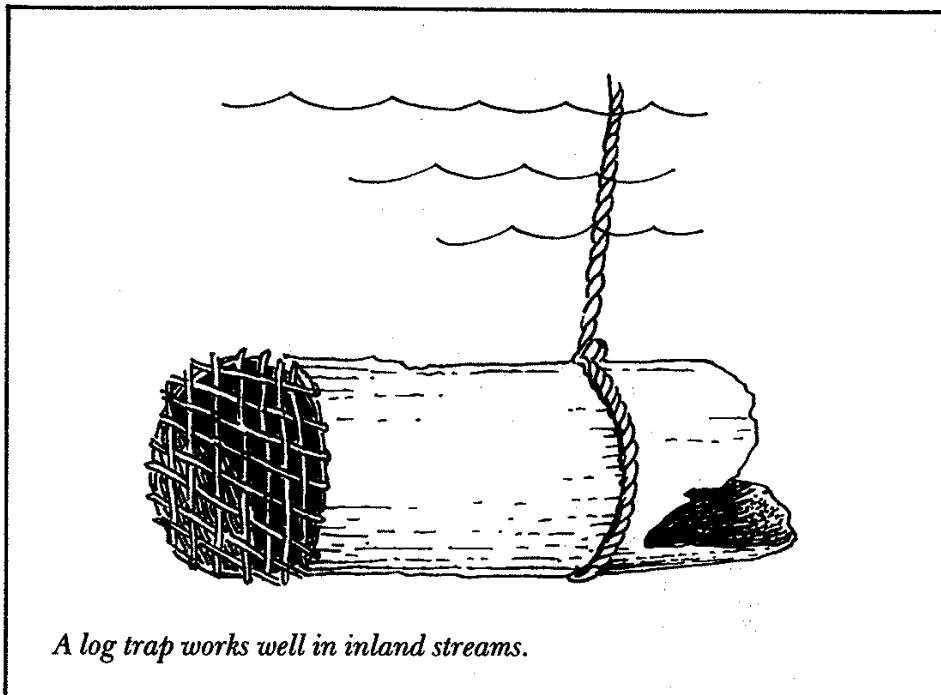

HOLLOW LOG TRAP This trap takes advantage of the fact that most fish cannot swim backwards. A hollow log is covered at one end with a piece of wire netting or other material which will allow a free flow of water. A rope sling is made in such a manner that, when it is pulled to lift the trap to the surface, it will tilt the hollow log so that the wired-in end is lowest. The bait is placed within a few centimetres of the wired-in end of the trap and it is then lowered into a convenient pool off a rock ledge. It may be necessary, depending on the type of timber, to weight the log by lashing several large stones to the side.

The fish swimming about in the stream will scent the bait and eventually find their way into the log. If the hollow is not too large they will be unable to turn around to swim out and will be trapped.

The open end of the log should always face upstream, otherwise the current may wash the fish free.

A similar method of catching smaller fish is with a pickle bottle. The bait, such as a piece of dough or other food, is stuck to the lower end of the bottle. It is then placed in shal-

low water on its side. All air must be removed. Small fish, such as sand mullet and whiting, will swim into the bottle to get at the bait and will be unable to back out. This is a good way to catch small fish for bait.

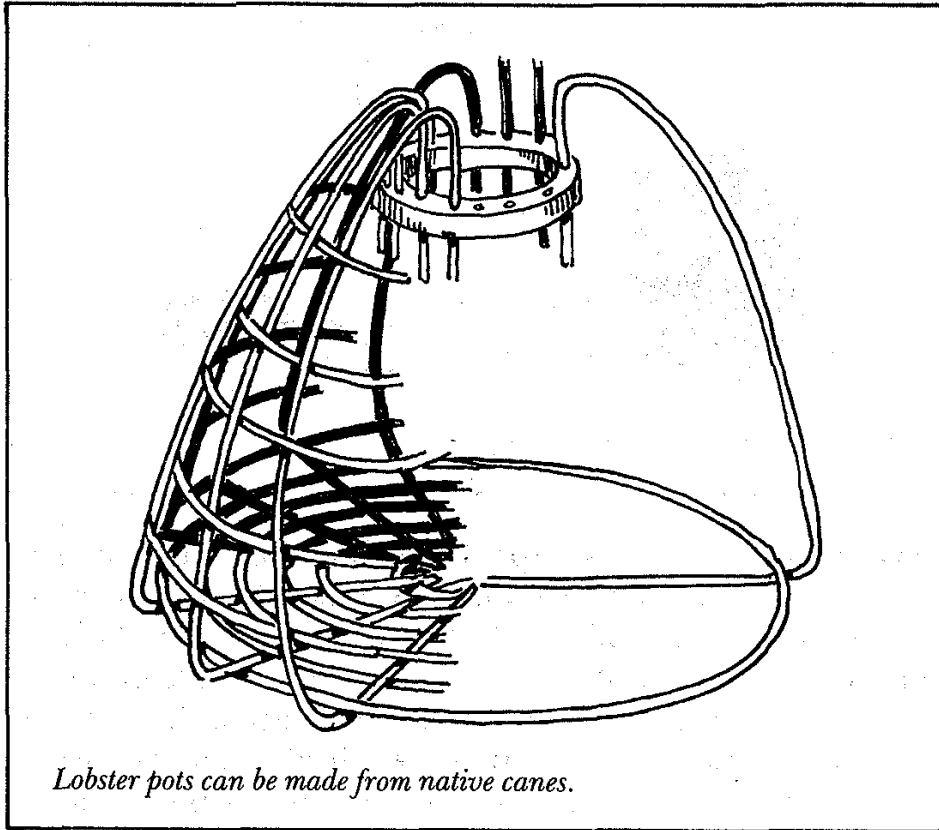

CRAYPOT A board about 30 cm square by 3 cm thick has a circle drawn on one side of it. The diameter of this circle is about 20 cm. It is then cut out with a fretsaw and 5 mm holes are bored around it. These holes should be about 3 cm apart. One and a half metre lengths of cane are put into each of the holes. About 8-10 cm above the board start weaving the cane so that its shape is that of a wide funnel. The upright canes are gradually bent down further and further with the weaving until they bend right over and point downwards to form the side of the trap. At this stage the trap is turned upside down for convenience and the weaving is continued. At the base, which should be about 60 cm from the top and about

a metre across the bottom, turn the canes inward sharply and continue weaving. This forms the bottom of the trap.

Weigh the bottom of the trap and bait it with old fish heads. Lower it into a rocky, weedy position. Lobsters live in caves in the rocks, generally in colonies. The fish heads should attract them to the pot. The hauling rope for the pot must be buoyed with a marker so that it can be found easily.

The pot may take a few days to weather after it has been first made. Several such pots set in a suitable area should bring a reasonable return.

IMPROVISED THORN FISHHOOKS Three long and strong thorns are cut with about 6 cm of wood left above the upward curve of the thorn itself. About 5 mm of wood should be left below the thorn. Make sure that the thorns are long, hard and sharp. The wood section is pared down with a sharp knife so that the angle of the thorn is about 120°. If this is done correctly the three pieces of wood with the thorns can be fitted

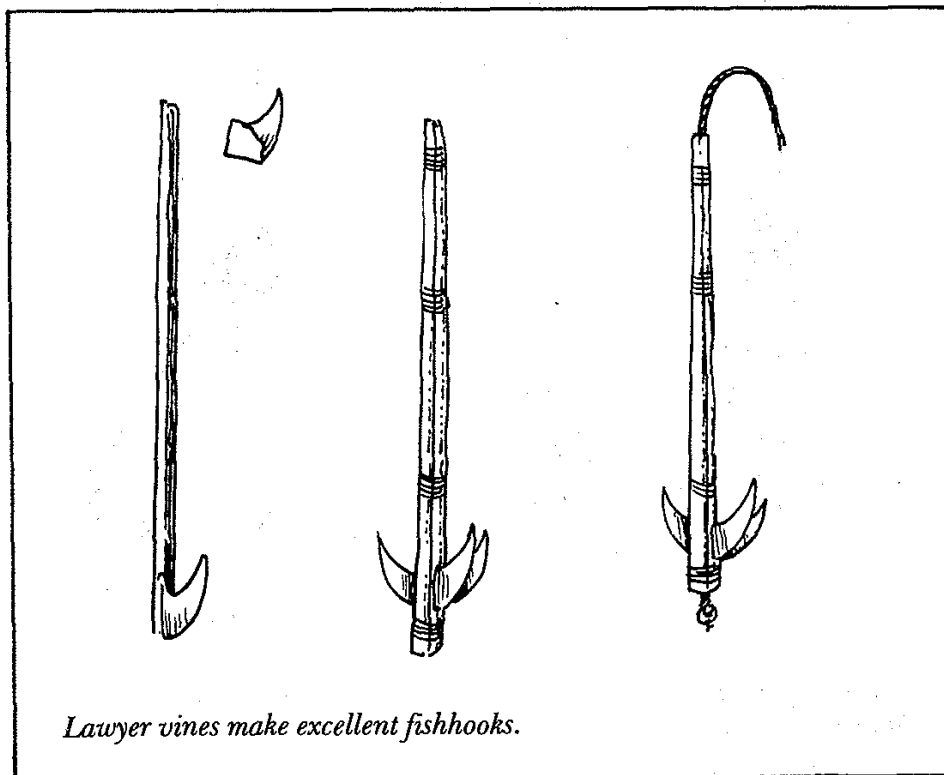

together to make a three-pronged hook. The wood is strongly bound with tough fibre thread at least twice on the shank and one below it. If possible it is advisable to bring the line, or at least a short length for a cast, down the centre where the three pieces of wood join. This cast should be finished off with a thumb knot at the butt of the hook so that it cannot be pulled through.

Hooks such as these are quite efficient and can be easily made by anyone with nimble fingers.

FISHING SPEARS The best time to spear fish is at night, using a flare or powerful flashlight to attract the fish. Sandy bottoms of a shallow estuary will normally yield good catches of flat and other types of fish. With spearing the aim is to pin the fish down to the bottom. Move your spear slowly until it is over the fish and then jab down suddenly. Fish spearing by day can be done from a boat or raft or from a rocky ledge.

Underwater goggles or a glass help you to see the fish bet-

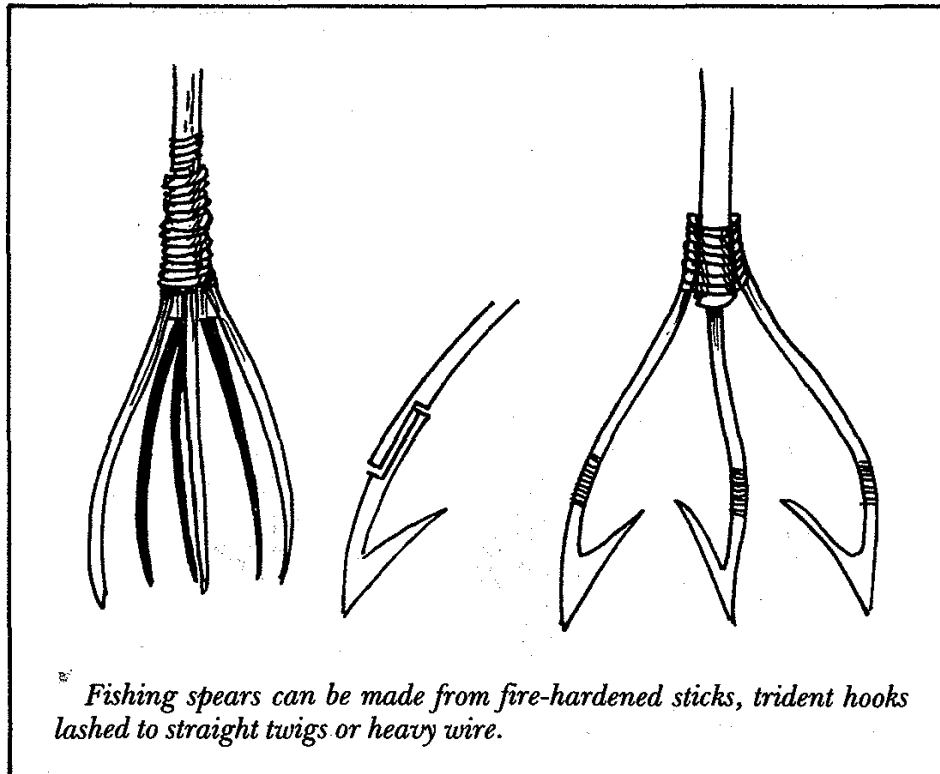

ter. A 'sea glass' can be made by cutting the bottom out of a used tin. You then look through the hole that the tin tube provides. The tin tube prevents surface ripples.

When fishing from a boat spear as nearly vertical as possible. Move slowly and quietly and allow for the angle of distortion caused by the water. Remember that fish have natural protective colourings to camouflage them against attack from predators from above. This will make them difficult to see at first until you gain experience. They are easiest to detect when they move or by their shadows against the sea bottom. Fish spears should be multi-pronged for greater efficiency and they should be barbed if possible.

An efficient spear is easily made out of several lengths of heavy gauge wire bound to a central striking handle.

They can also be made out of thorny, tough vines or split bamboo, the ends of which have been indented to make a barb.

STICK SNARE Surface feeding fish may be snared by means of a noose set on the underside of a weighted stick. The stick should be about 30 cm long. On one side a small chip of

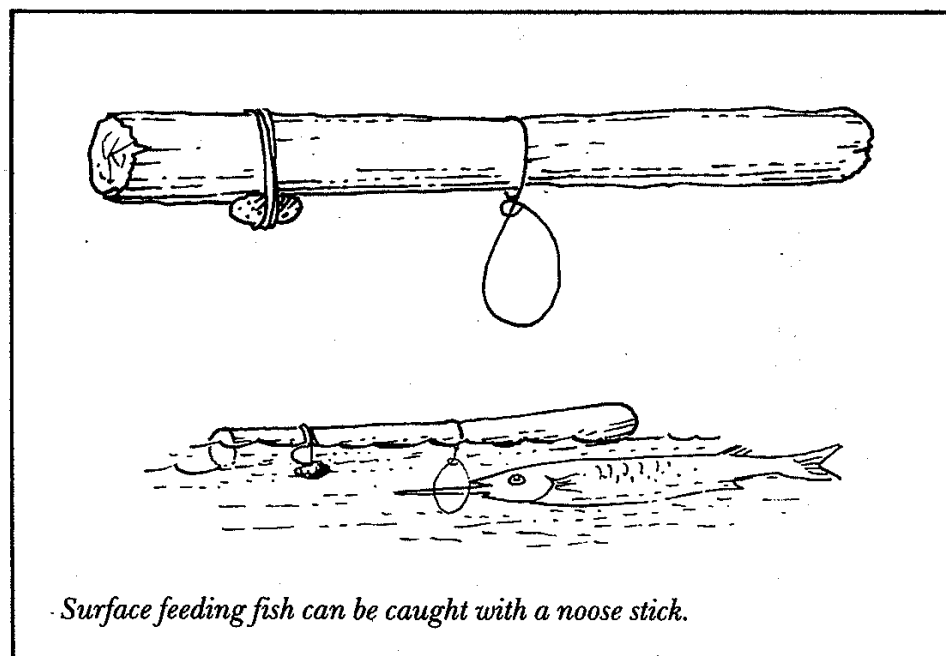

stone is secured either by tying or by splitting the stick and then driving the chip of stone into this. A noose of nylon line, horsehair or other thin material is tied to the stick. The noose itself should be on the same side as the stone chip. A number of these sticks can be made and thrown into the sea from a rocky promontory.

Surface feeding fish, such as Long Toms and garfish, take cover beneath any debris floating on the sea's surface to protect themselves from attack by birds.

If they hide under the noose sticks they will entangle either their bills or their tails. Their struggles against the noose will tire them out and the wash of the waves will then carry the sticks and their quarry to the beach. The beach should be patrolled at regular intervals to retrieve the sticks and their catch.

BAITED FLOAT STICK A fairly effective method of fishing with float sticks either in calm water or off beaches where

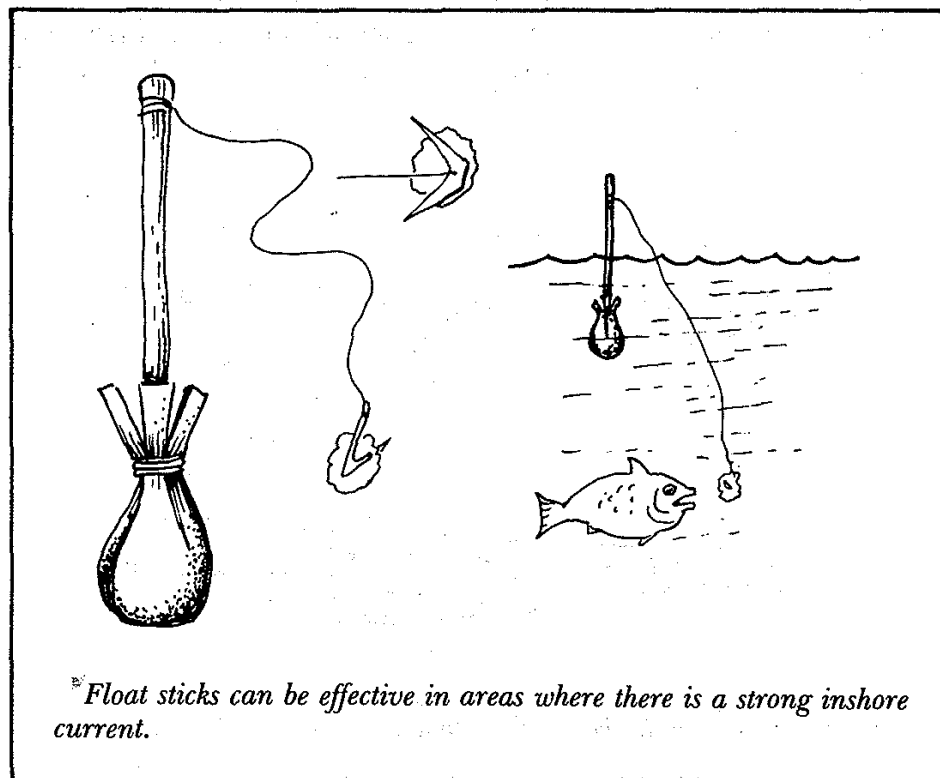

there is a 'set' or drift to the land is possible by constructing a number of float sticks to which a stout short length of fishing line, complete with baited hook, is attached.

These float sticks are made about 60 cm long. On one end a fairly heavy stone is attached by bark strips or cane. The weight will make the stick stand upright in the water. The line attached to the top end of the stick should be between one and three metres in length. The hook or a strong thorn or a carved piece of bone in the shape of a hook should be attached.

The sticks are thrown into the water and allowed to drift. The fish taking the bait hooks itself. It will finally exhaust itself and the current will take it to the shore eventually. If using this method of fishing it is necessary to carefully observe the drift or current so that you will know where to look for the sticks several hours after casting them into the water.

Food from the sea

FISH The sea and its shoreline, together with inland rivers, streams and billabongs, provides the richest source of animal food for the bushwalker or camper. More to the point it is all quite legal, except of course in national parks and wildlife reserves.

However, unlike the Australian bush, which is relatively benign, as long as venomous snakes and spiders are treated with extreme caution, the sea has a few more tricks to offer.

The list of dangerous sea animals off the coastline is well known and includes sharks, venomous tropical sea snakes, the stonefish, bluebottles, the box jellyfish and the blue-ringed octopus, plus the stinging cone shellfish and the aptly named stingray.

But there are also fish that are poisonous when eaten. Heading this list is the family of puffers, commonly called toados, plus the spiny porcupine fish. The liver and kidneys of both the toado and the porcupine fish are highly toxic and it is impossible not to rupture them when attempting to pre-

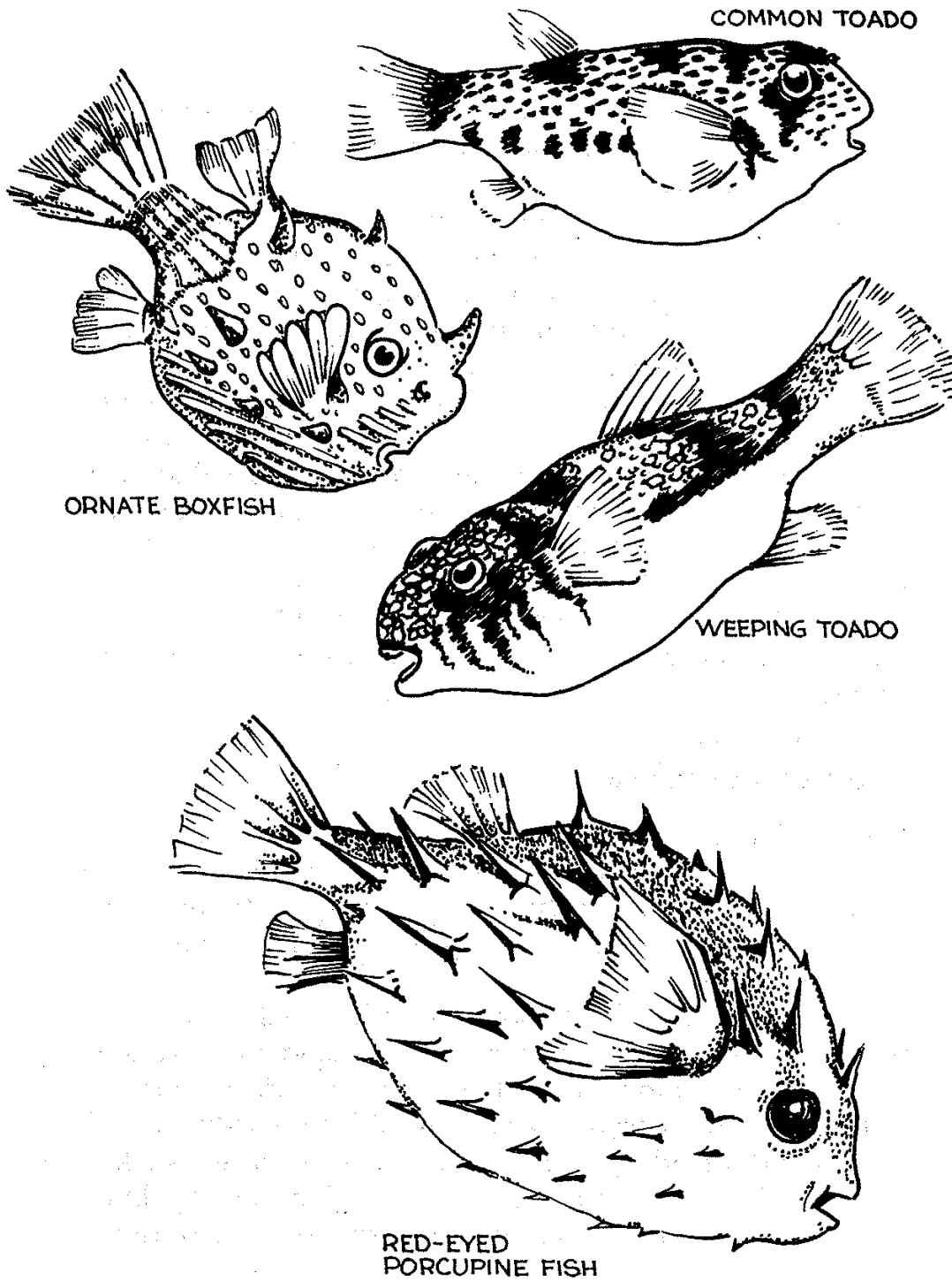

A portrait of the most deadly 'eating' fish in the sea. The picture here includes the common toado, the porcupine fish and the ornate boxfish. Any fish that puffs itself up after being caught on a line should be discarded.

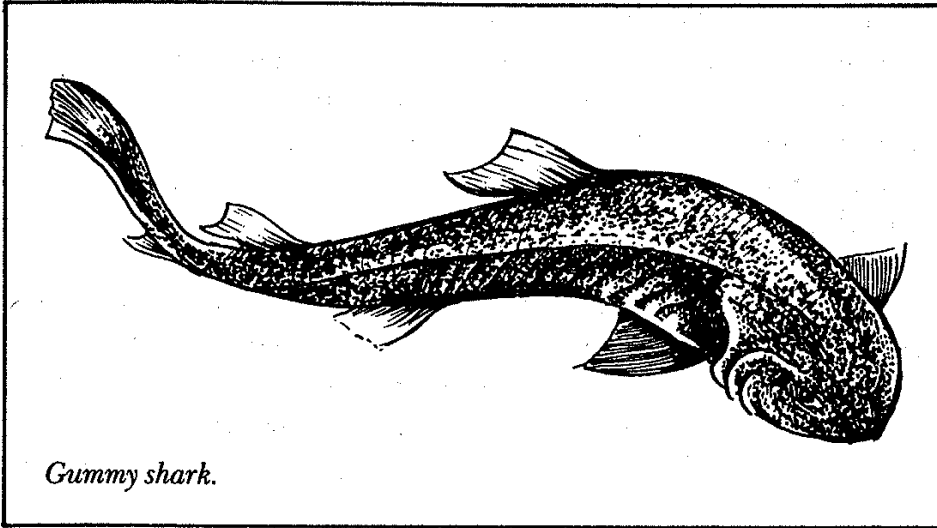

Gummy shark.

pare the fish. The only country where the toado is eaten is Japan, where it is a rather lethal form of oral gambling. Toado slicers have to be government licensed and even so the annual death toll from this sort of culinary adventure has reached 1000 in certain years.

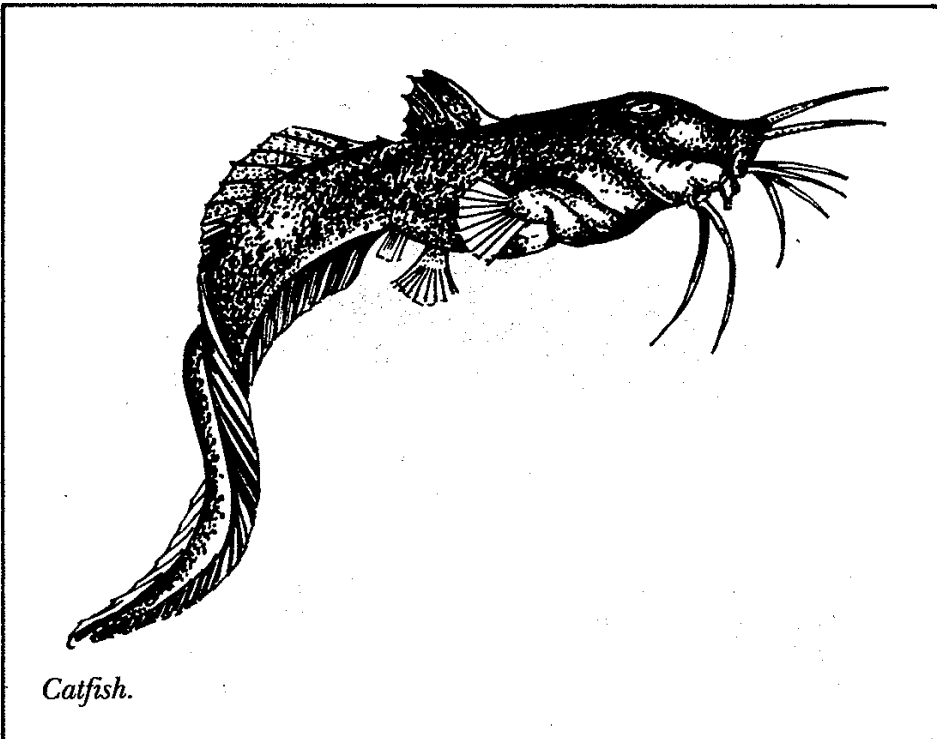

Catfish.

All toadfish and the other puffers have a leathery skin, having no scales. If caught they immediately puff themselves up to about twice their normal size. They all have protruding eyes. Boxfish, stargazers and cowfish are somewhat similar in appearance. For safety's sake all should be discarded, although it is claimed that the flesh of stargazers is edible, but not tasty.

Not all fish with leathery, as distinct from scaly, skins are toxic. Shark flesh is widely eaten but it should be gutted immediately on catching. The leatherjacket, likewise, skinned and gutted, is widely sold as a food fish. Some tropical water leatherjackets have rather bitter flesh. The one usually

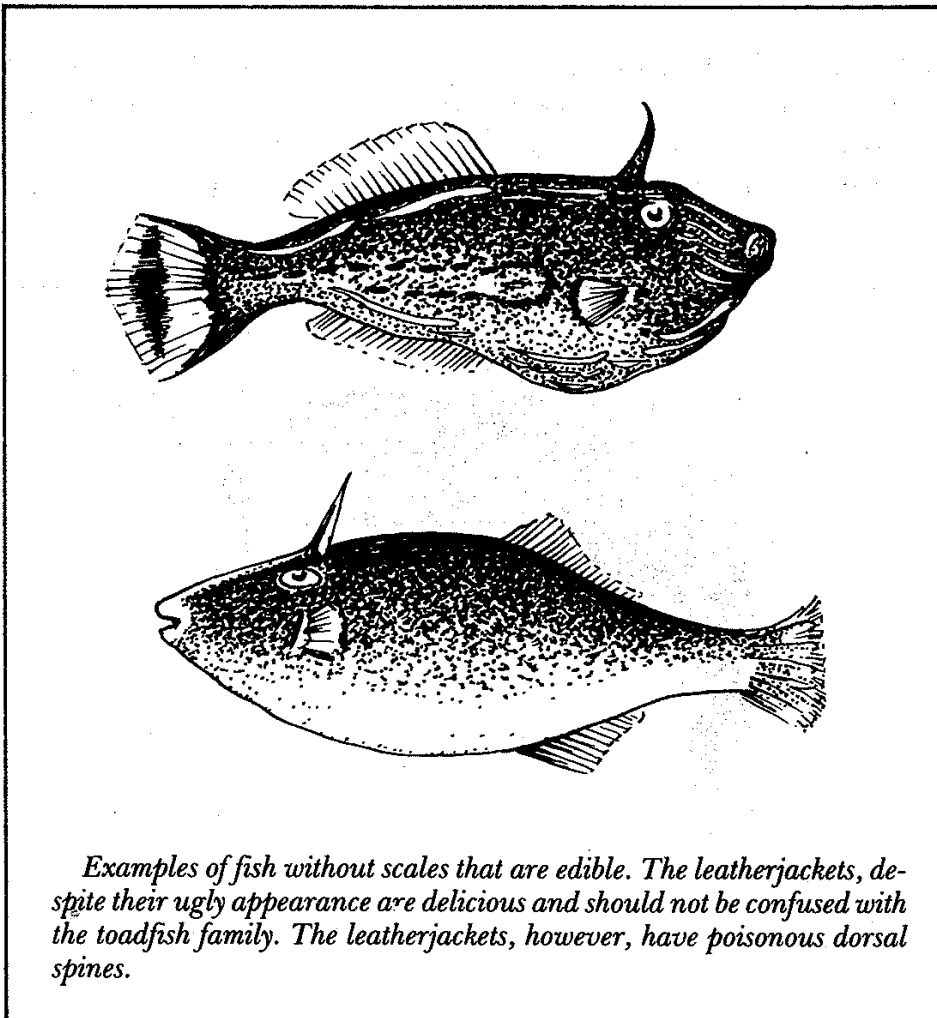

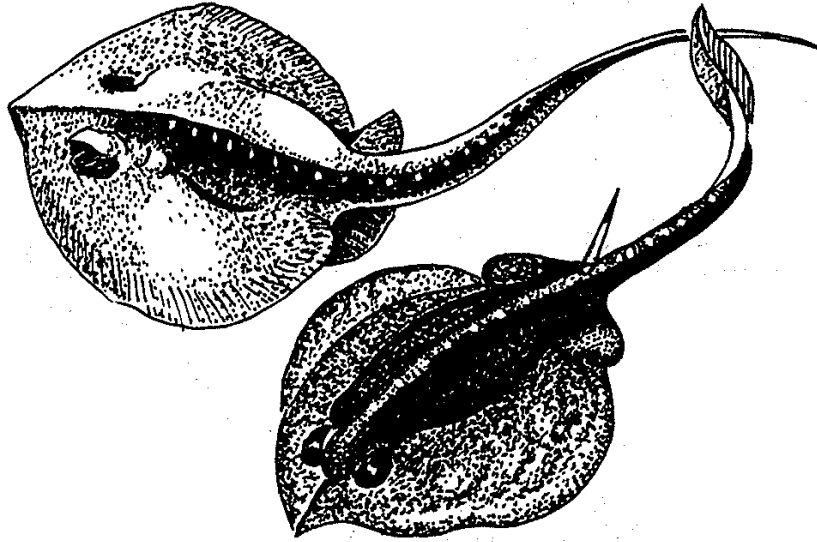

Although the common stingray can give an unpleasant wound from the 'sting' in its tail its flesh does not make bad eating. Wings of stingray are almost always called skate. They are the only edible part of the fish.

sold as a food fish is the Chinaman leatherjacket. Catfish also have no scales but are perfectly edible.

A simple rule of vision, if in doubt, is that if the fish looks too exotic or strange or blows or puffs itself in any way after being caught it should be discarded.

As a final note on leathery fish, while the wings of any ray are perfectly edible (they are usually sold under the name of skate) many of the estuary rays have a mildly venomous spine in the tail. Once landed they will use this tail spine to strike at their attacker. They can inflict a painful wound.

All freshwater fish are edible. The tropical barramundi is well known as a gourmet fish. Others include the Murray cod, the golden and silver perch and the introduced trout and carp. To these can be added freshwater eels, which are fairly plentiful — usually in deep, still pools, with overhangs. Eels will take almost any bait.



BARRAMUNDI



MURRAY COD



SILVER PERCH



EEL

The early white explorers despised the fish of Australian inland waters stating that they had no savour 'without butter'. Now that they have been almost exterminated we have come to regard them as delicacies. The barramundi, the Murray cod, the silver perch and the eel are widely fished by amateurs.

RAW FISH With the popularisation of Asian food styles in this country many more people are realising that fish can be delicious raw. Granted, in civilised surroundings the Japanese method of serving it is to provide relishes of grated raw white radish, green horseradish, carrot curls and soy sauce.

In a bush situation this elegance is not possible. But it should be remembered that raw fish, even by itself, is good to eat and can provide moisture as well as protein.

Fillets should be cut from the fish and these should be sliced thinly.

If any wild bush lemons or limes are available chunks of raw fish can be 'cooked' by steeping them in the citrus juice for an hour or so until the fish turns opaque. There is no taste of rawness. Polynesians enliven this basic mixture by adding sliced onions, tomatoes and other firm vegetables. The citrus juice mixture is usually drained from the fish chunks before they are served but in a survival situation it should not be wasted.

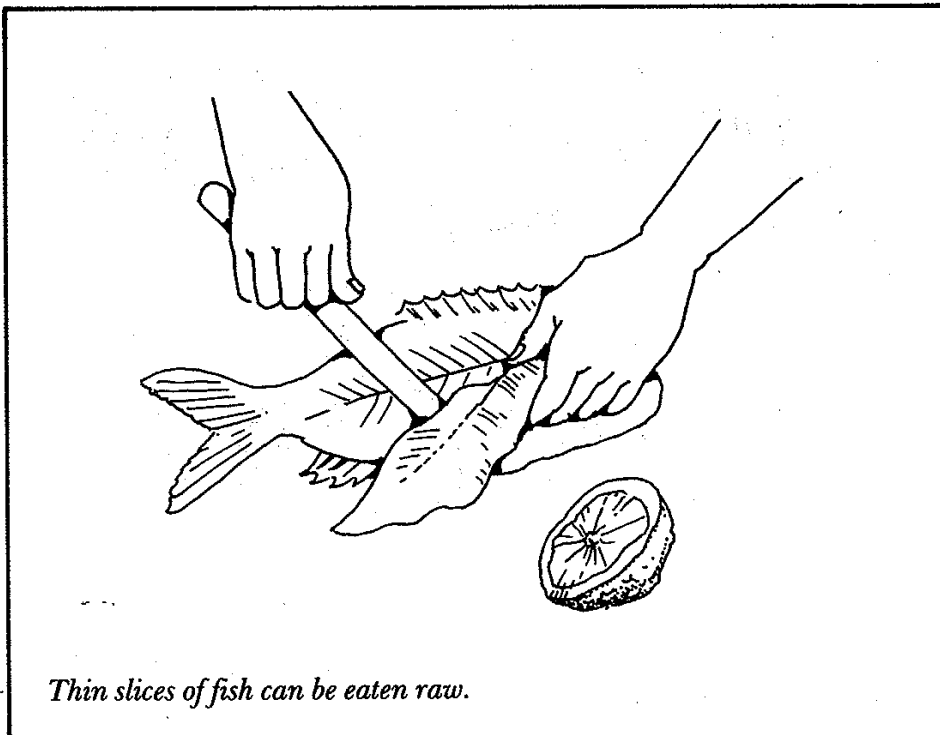

Once again, in an emergency situation prawns and lobster slices can be eaten raw, and in other countries are regarded as a delicacy.

SHELLFISH Australians today consume only a tiny fraction of the edible shellfish available along the coastline and despise absolutely the native freshwater mussel. All of the bivalves are edible and provide excellent — although at times tough — additions to a camper's diet.

When gathering any shellfish make sure that the water in which they are living is relatively pollution free. The word relatively is used with some exactness here. Almost all coastline waters are at least slightly polluted in one way or another.

Freshwater mussels, once consumed in enormous quantities by the Aborigines, should always be cooked before being eaten and thoroughly cooked at that. They often con-

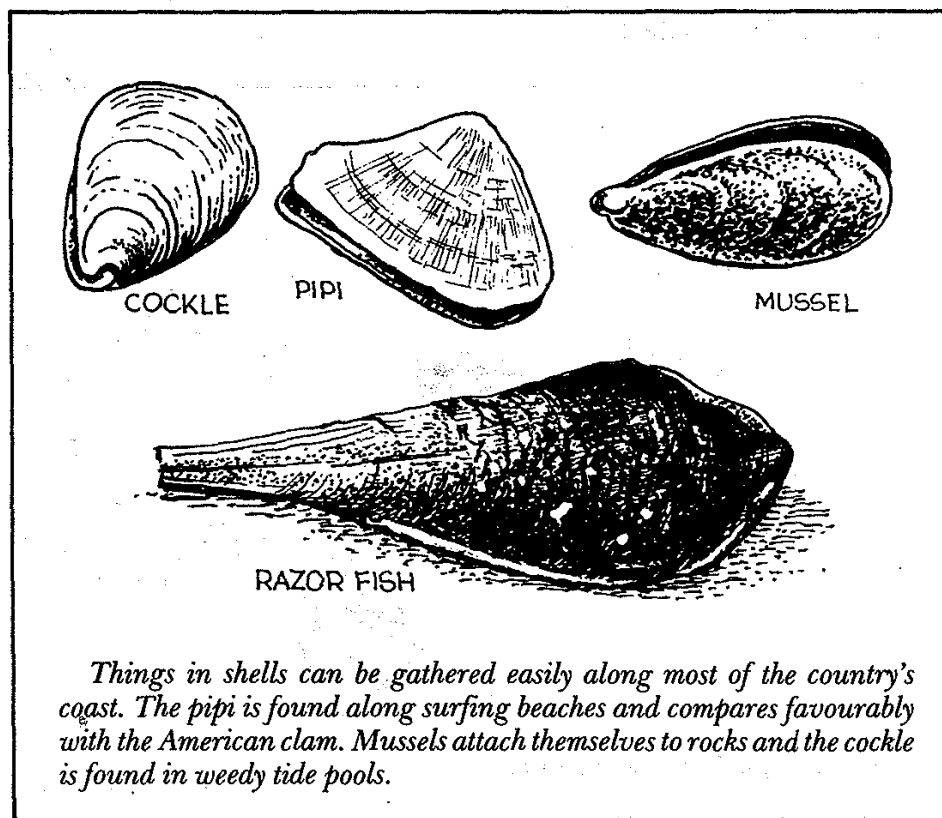

tain a parasite which can invade the human liver. The Aborigines ate them after first roasting them in their shells. They can also be made into a tasty soup. If extracting the meat for soup making either throw them into a pot of boiling water or pour boiling water over them to kill them and force the shells open. They are very difficult (if not impossible) to open when alive, especially the larger specimens.

The presence of freshwater mussels in a stream or water-course is usually indicated by open or broken shells lying along the bank. They can be harvested by walking along the creek bed and feeling for them with the toes. The mussels stand upright in the beds of creeks. Once discovered, they can be easily pulled out of the mud or sand.

Saltwater mussels usually attach themselves to rocks or pieces of wood. Exposed at low tide they are easily harvested.

The once-despised pipi is found along sandy surf beaches and is harvested at low tide by the barefoot toe probing method. Although somewhat sandy it can be steamed or made into a soup. One suspects there are more futile methods of removing sand from pipis than there are pipis. One method suggests they should be rinsed in several changes of fresh water over a period of about four hours, a second relies on soaking in seawater for twenty-four hours and a third insists that they should be soaked in a mixture of half seawater, half freshwater, plus a cup of oatmeal.

Whatever method is used, these shellfish are far less sandy if after soaking the gut sack is removed from the edible foot. This is tedious but worth it.

Among the other known shellfish, whelks can be found in rock pools, hidden among kelp and seaweed. Their flesh is extremely tough and unless finely minced almost unchewable. But they can be made into a soup, first by smashing the shell and removing the edible flesh, boiling it and straining off the liquid, which should be thickened. In a survival situation milk and butter would not be available. However, under more civilised conditions this is a vast improvement.

Other shellfish include clams and abalone. It is illegal to take clams in tropical Barrier Reef waters, although Asian

fishermen conduct poaching raids. The flesh sells for high prices in Japan. They are a much prized food in a number of the Pacific islands. The flesh should be separated from the gut sack and, after being beaten, thoroughly cooked to soften it.

Abalone once used to be plentiful along the coastlines of Australia. But commercial interests have now ensured that it is extremely rare and a high-priced delicacy.

The abalone (if found at all) lives near low tide level among kelp. They have a strong foot which anchors them to the rocks and usually have to be prised loose with a knife.

To cook abalone remove the fish from the shell, cutting the muscle at the top. Cut away the gut sack and trim the edges. The flesh should be cut into slices as thin as possible and beaten with a stout length of wood or a suitably sized smooth rock.

These beaten slices should be quickly fried or grilled on a very hot flat stone for about 30 seconds on each side and then eaten immediately. Longer cooking turns the abalone's foot muscle into very tough leather.

Like all other shellfish, they can also be made into a soup.

The best known and most popular of all ocean shellfish is the oyster. The only instruction needed here is to warn the walker to purchase an oyster knife if the trek is into oyster territory.

Besides these shellfish, there are many sea creatures along rocky shorelines that can provide a source of food. The tiny blue black periwinkles can be boiled up in a billy of salted water and their flesh extracted with a pin. The flesh of the common limpet can be used to make a passable soup, as can the flesh of the cart rut shell. Then there are the blue spiny sea urchins that hide in the kelp or live in crevices.

The pale orange roe of the sea urchin is the edible part of the animal. It has to be handled with extreme care, otherwise the sharp spines break off in the hands. The wounds are extremely painful and can turn septic.

The roe is normally eaten raw in Europe. The top of the urchin is cut off, the whole given a quick rinse in seawater

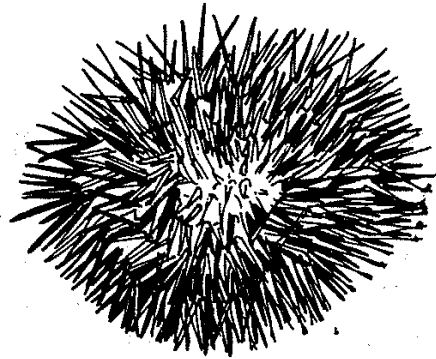
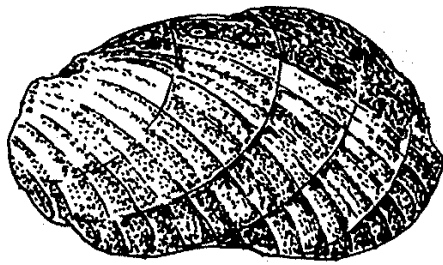

Abalone (top left), sea urchin (top right), oyster (bottom).

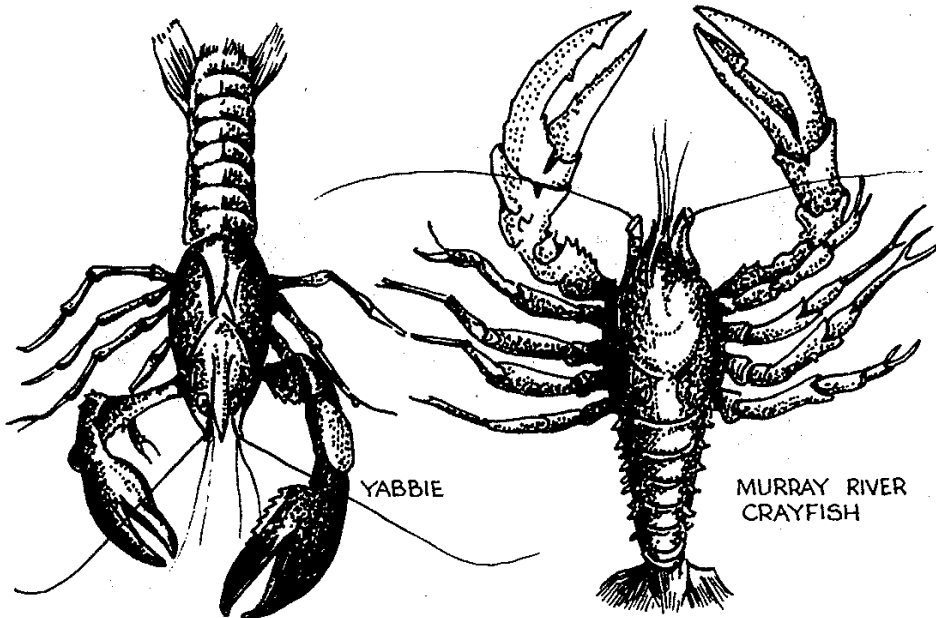

The humble yabbie and the Murray River crayfish make delicate eating. They can either be trapped or caught with pieces of meat on a string — the 'higher' the meat the better. Once having grasped the bait these freshwater crustaceans are reluctant to let go and can be grabbed by hand at the surface.

and then the roe is scooped out. Alternatively it can be lightly fried.

Freshwater crayfish and yabbies can be infected by parasites and so should be thoroughly cooked.

The simplest method of cooking any crustacean (salt or freshwater) is boiling. They can also be cooked by wrapping them in seaweed and steaming them, either alive or after killing.

OCTOPUS AND SQUID The flesh of both squid and octopus makes good eating but care is needed to avoid one highly poisonous member of the octopus family.

This is the blue-ringed octopus found in pools and semi-shallow water throughout the Pacific. It is an extremely tiny member of the octopus group, its entire tentacle and body length rarely exceeding 20 cm. Most specimens are much smaller. The body itself is usually no bigger than a match-box.

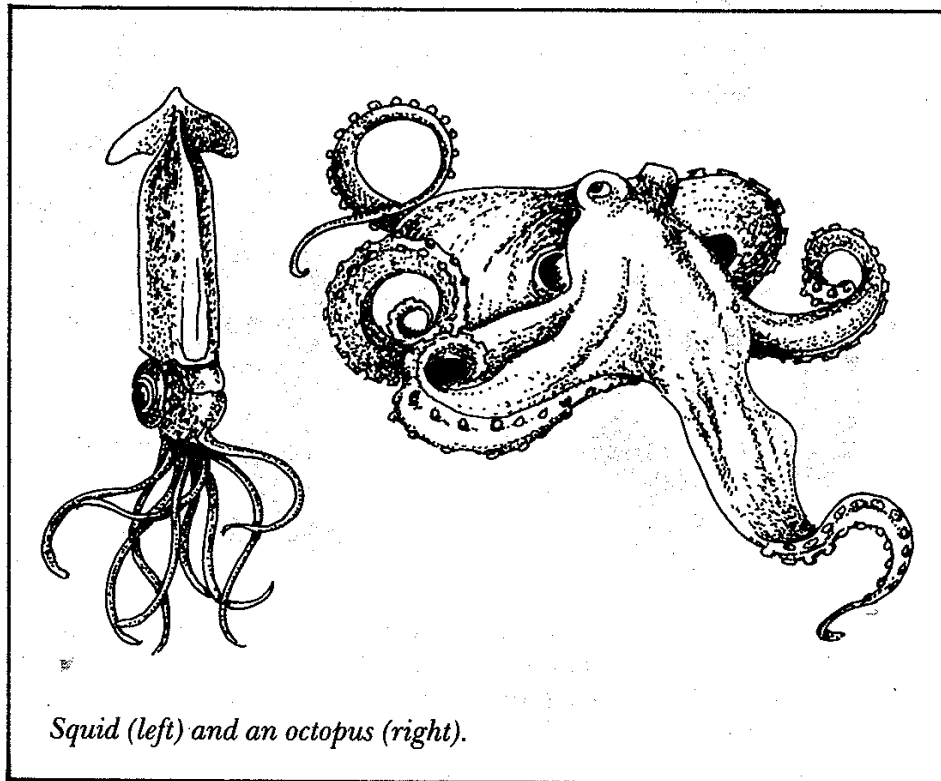

It feeds on rock crabs and care should be taken in and around large rock pools. Lying quietly in a pool it is dun coloured with brown or yellowish bands on its body and tentacles. But when it is disturbed, brilliant blue rings appear on both the body and arms. A bite from a blue-ringed octopus can paralyse a person within 15 minutes (the animal injects a nerve poison when it nips with its beak). A number of fatalities have been recorded.

Other members of the octopus family, although they can inflict a painful bite, are harmless although a pest to handle when alive.

To bush cook octopus tentacles, cut into thin slices, beat with a mallet and cook in hot fat or oil until they become tender.

Squid should be cleaned, turned inside out and the outside skin rubbed off, then sliced and fried.

Obviously there are more delicate ways to cook both creatures. Lemon juice can tenderise the flesh of octopus and, if in tropical areas, the flesh of a pawpaw is one of the best tenderisers of all.

Insects and grubs as food

There are several species of native bees in Australia. Unlike the imported European honey bee, many of them are stingless, a fact not often understood by those who have experienced the painful treatment meted out by 'normal' bees.

These small, black insects usually build their nests in the hollows of trees. A nest can often be located by observing a flight of the bees in areas heavy with pollen bearing flowers. A 'stain' is also often observed around the entrance to the hive. In emergencies these natural sugar stores can be axed out of a hollow tree and collected. The combs are often littered with dead bees and larvae, but the wild honey can be rinsed out with water.

In the drier areas of the continent honey ants are found. These are named because they store a sugary solution of food in their abdomens, which often become inflated to

about the size of a pea. These ants have underground nests and have to be dug out.

Large wood grubs, commonly called witchetty grubs, can often be found in the fallen trunks of both eucalypt and softwood tree species. The branch of the tree being searched must either be a freshly felled one or must be one that has been torn off by a storm a day or so before. If the tree has been 'down' for some time it will have started to dry out and the grubs will have deserted the trunk or branch for a more satisfactory edible home. Aborigines used to hook the grubs out of a living tree by using a thorn or an improvised long hook.

Any of the large white grubs are palatable if first roasted on a hot stone or lightly fried in a pan. For a brief period in the 1970s one Australian firm marketed canned witchetty

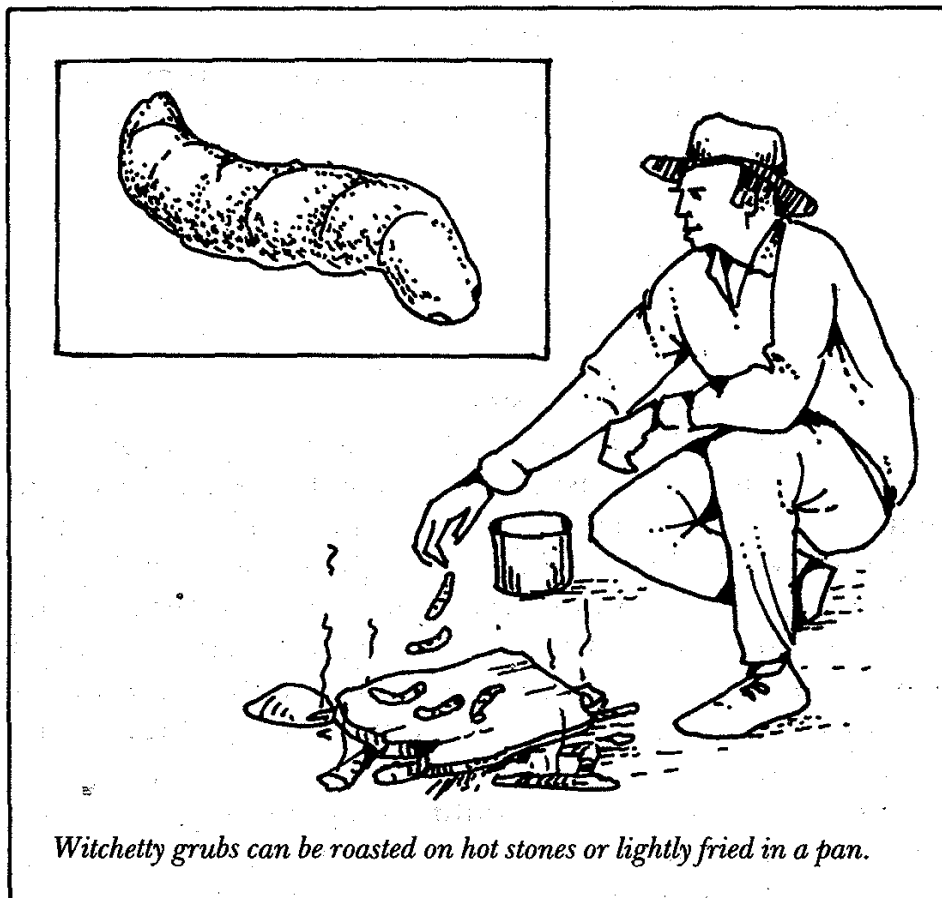

Witchetty grubs can be roasted on hot stones or lightly fried in a pan.

grub soup. Although popular as a novelty item for tourists, Australians themselves did not take to it. All the large white grubs have rather a nutty flavour when cooked.

Wild vegetables

Greenstuffs, roots, herbs, grass seeds, nuts and rather bitter wild fruits played an important part in the diet of the Aboriginal hunter-gatherers. In general they followed the pattern of most similar hunter-gatherer societies in other parts of the world in as much as about 70 per cent of their food needs came from gathered vegetable products and about 30 per cent from meat or fish protein.

Over many thousands of years tribal groups learned to recognise the properties of certain vegetables in their gathering area. They also learned how to leach out certain alkaloid poisons. Most of this knowledge of wild plant foods now has been lost and unless one is certain of what one is about to eat in the bush any plant should be approached with extreme caution.

There are two common poisons in the vegetable world. Both can be identified by taste.

The first is the taste of almonds, found in peaches and other stone fruits (especially in the kernels). This is the taste of prussic acid, otherwise known as cyanide. *Any* plant in the wild that gives off this taste or, when the leaves are crushed, smells of almonds should be discarded as a food source unless previous experience has taught otherwise.

The second poison is oxylate of lime, contained in many of the lilies and some of the yams. The presence of oxylate of lime or oxalic acid once again is quite easily detected in any plant. If a small piece is cut off and tasted an acrid, burning and numbing sensation affects the lips and palate. It can also cause nausea, vomiting and in severe cases diarrhoea. In the case of the yams it can be washed out by grating the raw plant and soaking it in water. In some cases the starch will settle to the bottom of a container and the rest of the material can be discarded. In other cases after an initial

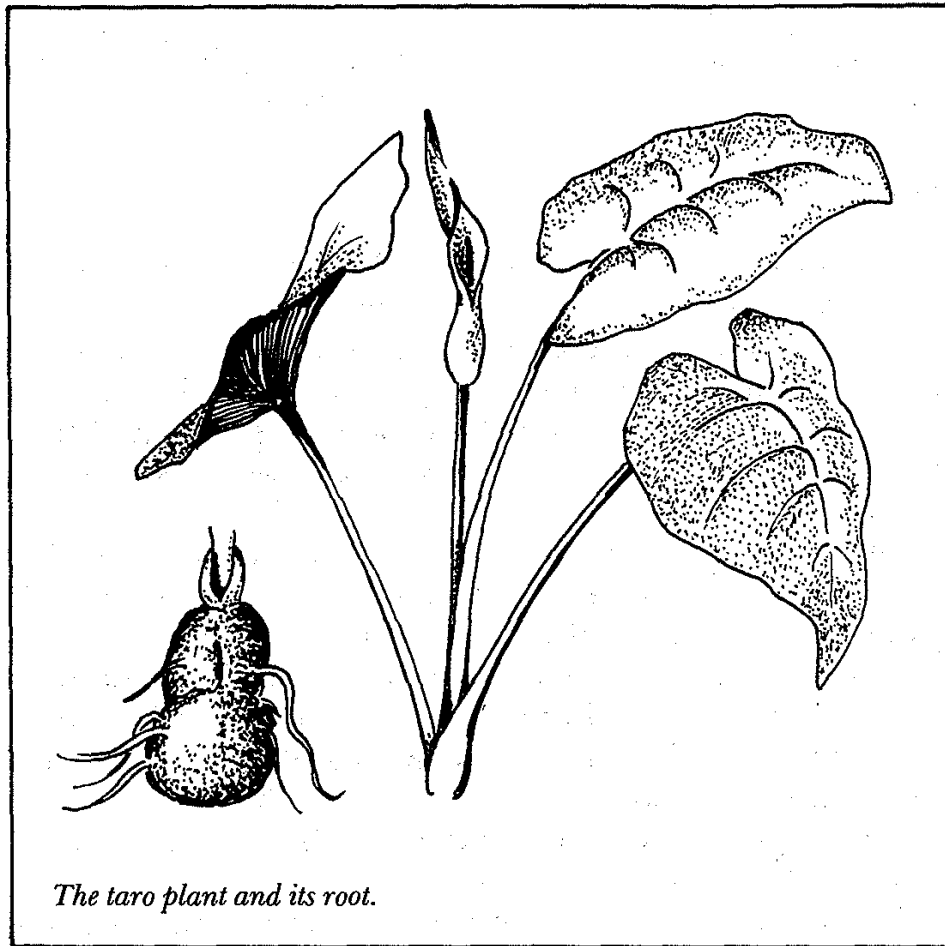

leaching process the whole fibrous mass plus the starch can be used as a food.

The tropical taro is another plant which has to be treated in this manner before being used, although some types can be merely boiled or baked.

The leaves of the taro can be eaten but they must also be boiled first and the boiling water discarded to rid them of their oxalic acid content. Treated in this manner the taro (both tubers and leaves) is one of the staple foods of the Pacific Islands.

After all that it will probably be welcome to know that one can at least get a cup of imitation tea out of the Australian bush, at least in swampy coastal areas. The tree that provides a pleasant substitute is the genus *Leptospermum*. In the early

days of white settlement the leaves of various members of the tea-tree or paperbark family were widely used as a tea substitute.

They were dried and then infused in boiling water in the manner of ordinary tea leaves. One of the favourites was the common lemon scented tea-tree, which is native to coastal New South Wales. All the tea-trees, however, will provide a

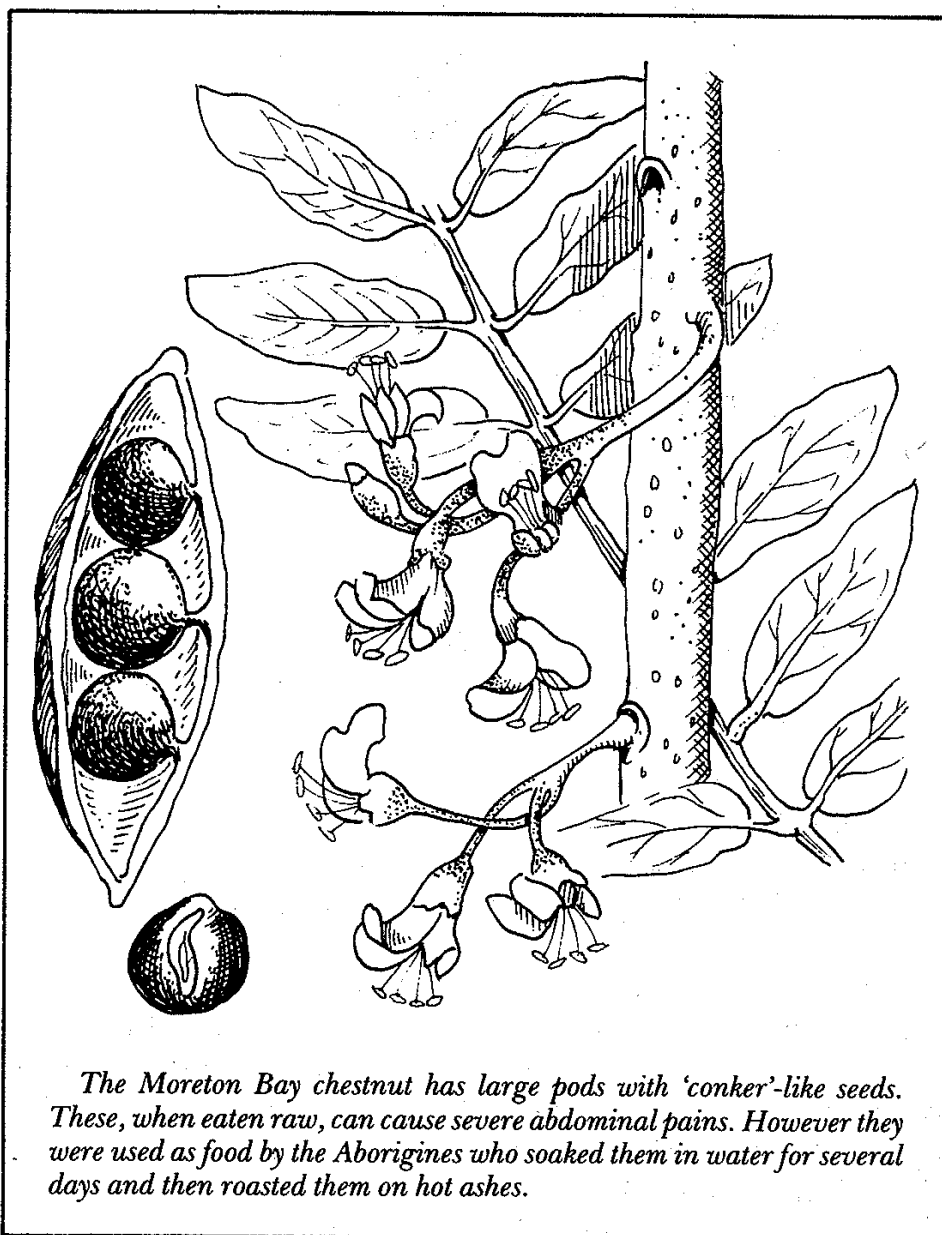

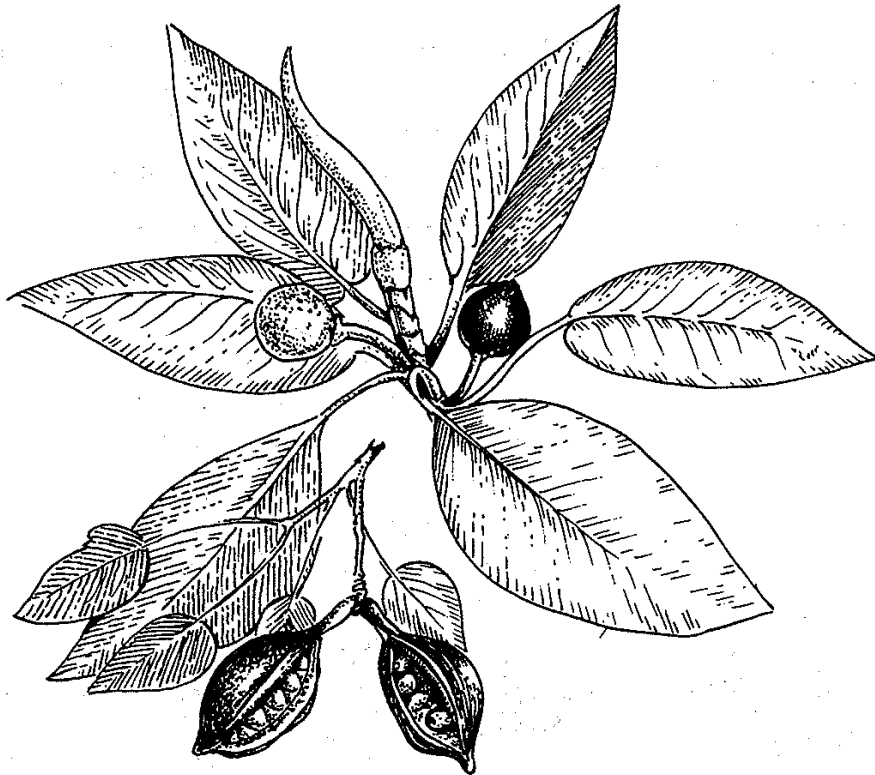

The Moreton Bay fig, like many others, range up and down the wet east coast of Australia. Their fruits are primitive — the tree has never been 'improved'. But they are palatable when ripe.

drinkable beverage. The green leaves, while more powerful, can be used in moderation and on a cold wet night, given a fire and a billy, will provide a more tasty beverage than hot water.

There are other useful Australian trees — the macadamia, the bunya pine and the quandong to name but three. But these grow in isolated pockets of the country and cannot be relied upon as sources of regular food. The bunya pine, for example, has a habit of cropping about once every seven years. The pine fruits are also probably the most lethal food crop known. The cones, which can weigh from 10 to 20 kg,

often fall from a height of 20 metres or more to the ground. Although the nuts are edible either fresh from the burst cones, or roasted, their delivery can be deadly.

The macadamia, which grows in temperate to tropical coastal areas along the east coast, provides, gram for gram, one of the richest sources of protein and essential oils in the world. Unfortunately, when ripe the shell of the macadamia has to be crushed with about a 10-tonne weight. The quandong, a widely distributed fruit in the semi-dry northern areas of Australia, was used by early white settlers to make jams and jellies. It can be eaten raw, although it is somewhat acid. The fruit of the quandong is bright red when ripe and can be dried and stored for future use.

The fruits of all the Australian native figs — the Moreton Bay fig tree being the best known — are also edible when completely ripe, although somewhat dry and flavourless. Despite this lack of flavour to a Western palate they will provide enough fruit sugars and bulk to sustain life if eaten in sufficient quantities.

Along the coastlines of the continent one of the most readily available edible greens is known as New Zealand spinach (*Tetragonia tetragonioides*). It is a prostrate sprawling plant with spinach-like leaves and that is what it tastes like. The commonly called 'pigface' (*Carpobrotus*), with its purple flowers, is also perfectly edible and useful as a source of 'fleshy water'. Pigface in at least one instance allowed an early European explorer to stay alive. John Eyre ate the fruits of the pigface and found them 'both grateful and refreshing'.

Inland the introduced prickly pear can be stripped of its spines and the flesh eaten both to quench thirst and to provide a supply of vegetable food not dissimilar to the mineral balance found in such green-grocery plants as zucchini or marrow. The fruit of the prickly pear is still made into a jam or jelly in some parts of the continent.

Other species that should be mentioned — both native to the country and introduced — include the 'fiddle' heads of ferns, including bracken, the hearts of cabbage tree palm, the sow or ordinary thistle (sometimes known as dandelion),



A number of plants, both native to this country and imported, can be used for food. One that is now cultivated is New Zealand spinach. Others that should not be overlooked are the stinging nettle and the sow thistle.

pigweed, watercress, and the introduced stinging nettle, which used to be a standard source of both spring greens and also bedsheets (the stalks were threshed and the fibres woven) in Scotland. Stinging nettle, found near almost every mining settlement in Australia, can be boiled like spinach and contains similar nutrients. In the Old World it was used as a 'spring tonic' green.

Other plants that can be found in the wild include a native variant of the European sorrel. This was first picked by a European at Botany Bay. While the leaves are smaller and spear-shaped they have the European cousin's distinctive taste of lemon, which in both cases indicates the presence of oxalic acid.

Small amounts are tasty and of nutritional advantage. Larger amounts can make one ill. The native Australian version is generally called sheep's sorrel.

Occasionally walkers may find an upright straight-leaved plant, generally known in this country as wild turnip. It is actually salsify or the oyster plant. It is a declared noxious weed in many parts of the continent. The root is similar to a very thin turnip and in the autumn it has mauve to purple flowers. When well boiled it tastes rather like the oyster from which it gets its second name.

Like watercress, nettles and to some extent New Zealand spinach this plant is often found near abandoned settlements or ruined cottages. These places should not be despised as vegetable food sources for those in distress or hikers who want to add freely to their carbohydrate supply.

Finally in the free vegetable area one should turn, especially for inland walkers, to pigweed, sometimes known as purslane, often sold in markets as 'inland watercress' and officially known as *Portulaca oleracea*.

This often used to be used in the early days of European settlement as the only available source of greens. The leaves can have a slimy feeling in the mouth. But it has one advantage in that it can take to dry soils and almost sandy desert, given a little rain. It can be a valuable source of green if all else fails. It is claimed to prevent scurvy but — like many

other Australian plants — its properties have not been fully investigated.

To end this discussion on edible greens, any walker may discover a new food source because of the lack of plant research into the natives of the country. Initial research in the 1970s by the CSIRO — somewhat belated — has shown that there are close relatives of the soy bean, rice, sorghum, some citrus (as has been already mentioned in the native lemons), banana, lettuce and the now very fashionable snake bean (which is actually a member of the pea family) alive and well in various parts of the continent.

FUNGI Absolutely safe members of the common fungi family in Australia are the common field mushroom and its close relative, the horse mushroom, plus the white-centred puffball. All other members of the fungi grouping must be regarded as suspect. This is because almost no identification has been carried out on the various species. A Scottish expert who came to Australia in the mid 1970s has yet to release his findings. However, he did say when he left the country that although some species of fungi appeared to be closely



Mushrooms and some other fungi are safe to eat but they should be identified with certainty.

related to those of the Old World, initial testing showed them to be toxic.

Members of the fungi family contain almost no carbohydrates and a minimal amount of protein. But they are very rich in mineral salts, which in extreme circumstances can help one to survive.

Apart from common mushrooms, friends of the author have tested small and large puffballs, plus samples of the slender parasol mushroom (edible and good) and the introduced saffron milk cap which grows under introduced pine trees (mainly *Pinus radiata*). The latter was somewhat tough and tasteless.

Water in emergencies

An old maxim that goes back to the mid-nineteenth century declares that a human being needs an intake of at least eight pints of liquid a day to survive adequately. In present day terms this is roughly 4.5 litres. When this theory was first propounded and then repeated and repeated yet again the *liquid* translated itself in peoples minds into pure water.

What most people forgot along the way was that most natural foods, fruits and vegetables in particular, are themselves composed mainly of water. Meat, whether raw or cooked, contains water and so does bread. In extreme circumstances one does need the 4.5 litres per day. Under normal circumstances two litres will do in temperate conditions. As the temperature rises more fluid is needed.

There are no hard and fast rules here. No two human beings are exactly the same. Some people lose water faster through sweat than others. Yet another group, especially under humid tropical conditions, will show signs of 'salt starvation' sooner than they show signs of water deprivation.

It was not so many years back that Europeans in tropical countries were advised to take salt tablets every day, apart from the salt they took with their food. This medical fashion would have amused both the Bushmen of the Kalahari desert in South Africa and certain Pacific Islanders if they

had been told of it. Certain 'expert' bushcraft books in recent years still fall into the salt warning trap, despite the fact that this theory now has been completely discredited. Yet others have raised the water intake to a *minimum* of 6 litres per day.

It is interesting to note here that Queensland 'burr' and prickly pear cutters in the early part of this century learned one rule very quickly (and these were northern European migrants in the main). They were working in the dry inland areas of the State without expert or fashionable medical advice, it must be understood.

The rule was rigid. It went thus. One quart of lukewarm black sugarless tea at dawn. One billy (quart) of cold sugarless tea at noon and another quart of hot tea (perhaps with sugar) back at camp at dusk.

That intake came to six pints. Those men were not only bushwalking they were cutting, bending, slashing and digging as they went. It was regarded as suicidal to drink as one worked or walked. To moisten their lips during the heat of the day they used the technique of a small round pebble in the mouth (the forerunner of chewing gum). It must have worked. Many of their descendants now own most of Queensland's inland.

Having said that, it should be stated very firmly that no one who goes camping, bushwalking with a pack or camp-driving with a vehicle, should leave his or her base without either an adequate supply of water or knowing where the next *reliable* supply of water can be found. It has been said so often that the saying has become a truism: Australia is the world's driest continent.

People who live on the comparatively wet seaboard areas often cannot understand this. But even in these comparatively lush areas drought is not unknown. Coastal national parks, for instance, not only dry up but they can burn to the ground as well. In the early days of European settlement escaping convicts, convinced that China and freedom was just up the road, died of thirst on the seacoast before they had walked 100 km. It is an historical message worth remembering.

WATER INDICATORS IN THE ANIMAL WORLD In circumstances where you have run out of water, or are perhaps about to, certain members of the animal kingdom may be able to give you a helping hand.

This information is not infallible. Like human beings, other members of the animal kingdom will behave erratically from time to time. This, therefore, is only a very general guide.

Wild bees, like their domestic counterparts, find it extremely difficult to survive without water. They generally site their tree or log hive no more than 5 or 6 km from the nearest source. The source, in bad conditions, may be no more than a surface damp soak. It will then be necessary to dig and perhaps filter the water to provide enough to drink.

Many species of ants can also lead the camper to water.

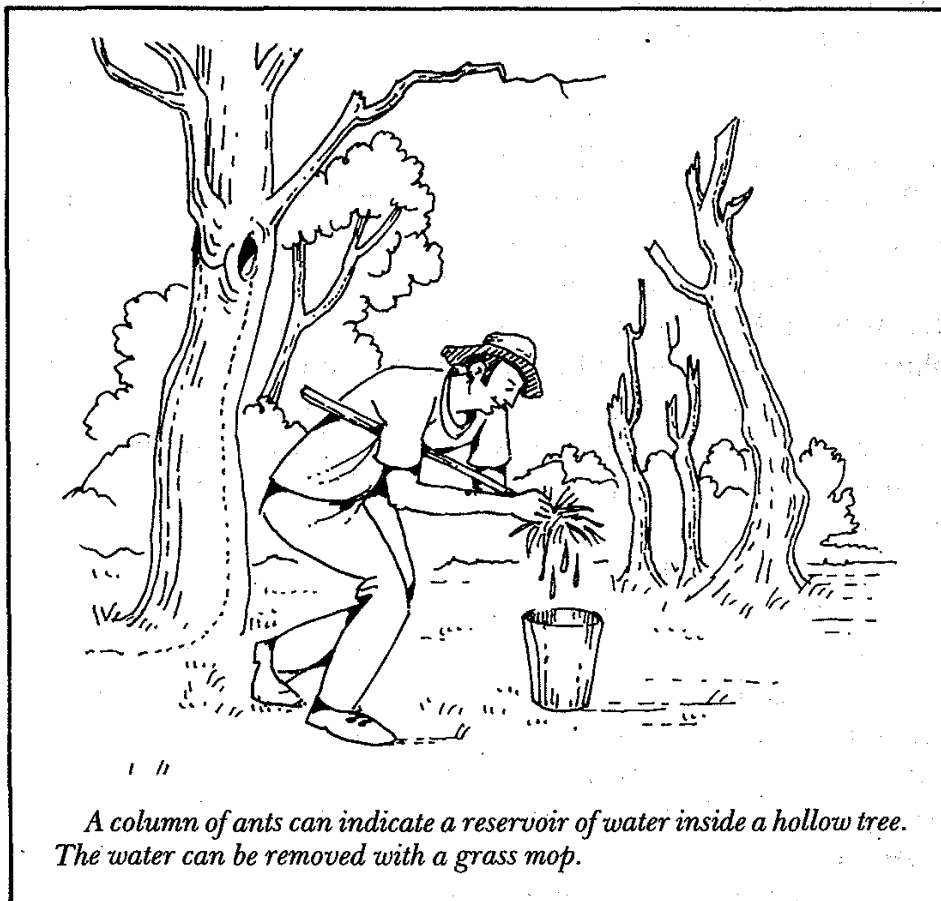

A column of ants can indicate a reservoir of water inside a hollow tree. The water can be removed with a grass mop.

But once again, like the bee supply, it may be limited. If you see a steady column of small black ants climbing a tree trunk and disappearing into a knot hole it is highly probable that the interior of the tree is hollow and there is a reservoir of water there.

This can be proved by dipping a long straw or stick down the hole into which the ants are disappearing. If it is wet when you draw it out there is water present.

This water can be mopped up by tying a bunch of grass onto the end of the stick and lowering it into the hole, removing it and squeezing it out into a container of some sort. Do not chop into the tree otherwise the water will be lost as you will undoubtedly break the reservoir in one way or another.

These reservoirs are common in the river-bank casuarinas (she-oaks) and certain large wattles that grow along water-courses in dry, inland areas.

Another insect that is a variable indicator of presence of water is the solitary wasp or mason wasp (*Monerebia ephippium*, of the broad family *Eumenidae*).

These orange and yellow insects with a broad black band around their abdomen are indeed solitary, to give credit to one of their common names. They are also masons, collecting mud in their breeding season to make nests in which they place paralysed insects for their hatched larvae to feed on.

Their nest building activities take place in early summer. In dry, inland areas, because of their desire to both build and breed, they will lead the walker to at least a damp patch in the soil.

Digging around this area may, with luck, lead to a soak about 10 cm below the surface. Unfortunately they may also be making mud balls out of kangaroo and wallaby urine or even soil slightly dampened by overnight dew. The presence of mason wasps in any area cannot be taken to mean that there is a sure supply of water.

However, it is worth following them on a 'just in case' basis.

Outside of the insect world, most grain-eating birds need

to drink daily. This applies to both the Australian native finches and the pigeons. At dusk both of these species will make for a source of water.

However, they should be watched carefully. If they are flying low and quickly they are making for water. But if their flight is from tree to tree and slow they are returning from drinking.

Parrots are irregular drinkers and their flight paths at dusk mean little or nothing. The same applies to all birds of prey, unless one wants to take the risk that they are seeking their evening meal from the water drinkers at a soak.

The tracks of kangaroos, wallabies, feral pigs and wide-ranging domestic stock may also lead one to water. Most of these grazing animals drink at least once a day, like the birds at dusk.

On the other hand these animals can go up to three days without drinking at all. So unless there is a regular track or several regular tracks pointing in a specific direction one's luck may be out. In general the water source will be found by following the animal trails downhill.

WATER FROM VEGETABLE SOURCES In inland areas many trees can be used for water no matter how dry conditions may appear to be. A very small list of these trees includes the bottle and the related kurrajong, the mallee and the rather aptly named goldfields water tree.

The best way to get water from any tree is to drain the roots. To do this they should be cut just about dawn when the tree itself has finished its night dew-collecting efforts. They are dug up, cut into lengths of about a metre and these lengths pointed downwards into a billy or other container. To do this they can either be hand-held (rather laborious) or laid on a natural or artificial dirt slope with the billy at the end of the cut drip line. Generally speaking the roots must be cut at an angle of 40-45°. Never break or tear them because this prevents the water draining from them.

With luck and in tolerable conditions each of the metre-long root pieces will yield up to about 100 ml of water. This

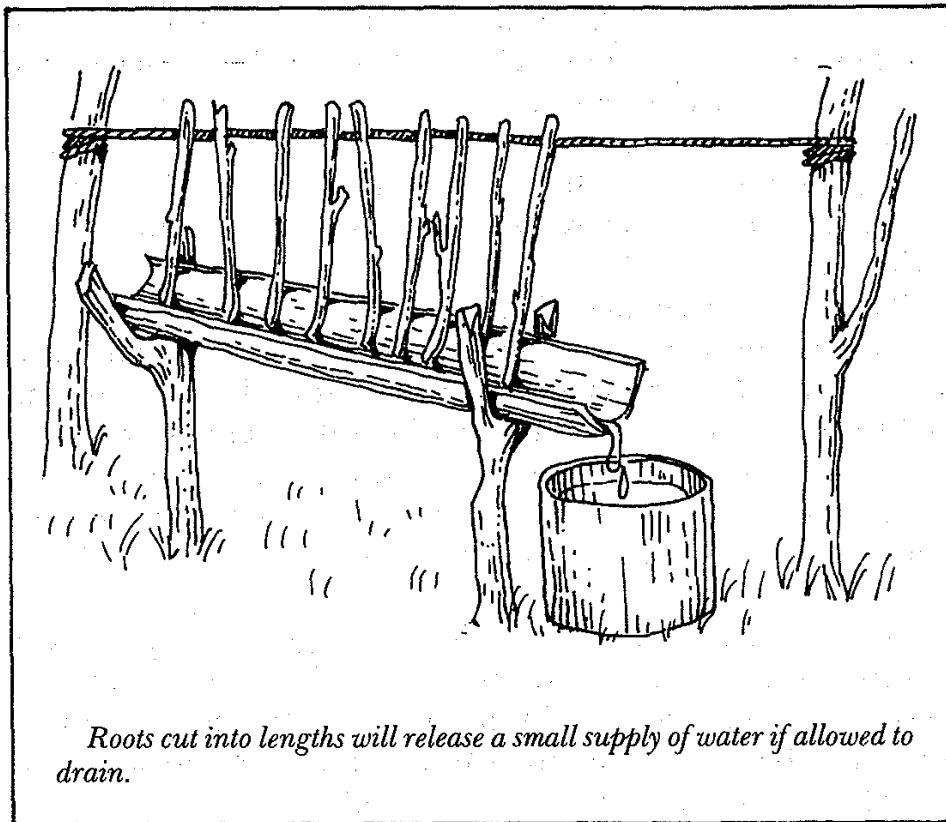

must be used more or less immediately and not allowed to stand. Strictly speaking it is a water plus sap mixture and because it contains a number of natural sugars it will ferment once the sun gains strength.

There are certain precautions and a few danger signs in regard to the tree root 'water'. If the fluid is milky or coloured in any way it should be regarded as being potentially dangerous, not only to drink but also to the skin. Many of the milky saps, except those of the *Ficus* family which contain latex (a natural rubber), are extremely poisonous. The milky sap of many weeds can poison the skin and cause bad sores and, if allowed to get into the eyes, may cause blindness.

With all vegetable sources the point to remember is that even though the fluid itself may be clear and sweet smelling it should be tasted cautiously first. If it is flavourless — or almost — then it can be assumed that it is safe to drink.

In general in arid areas, water from roots of trees and

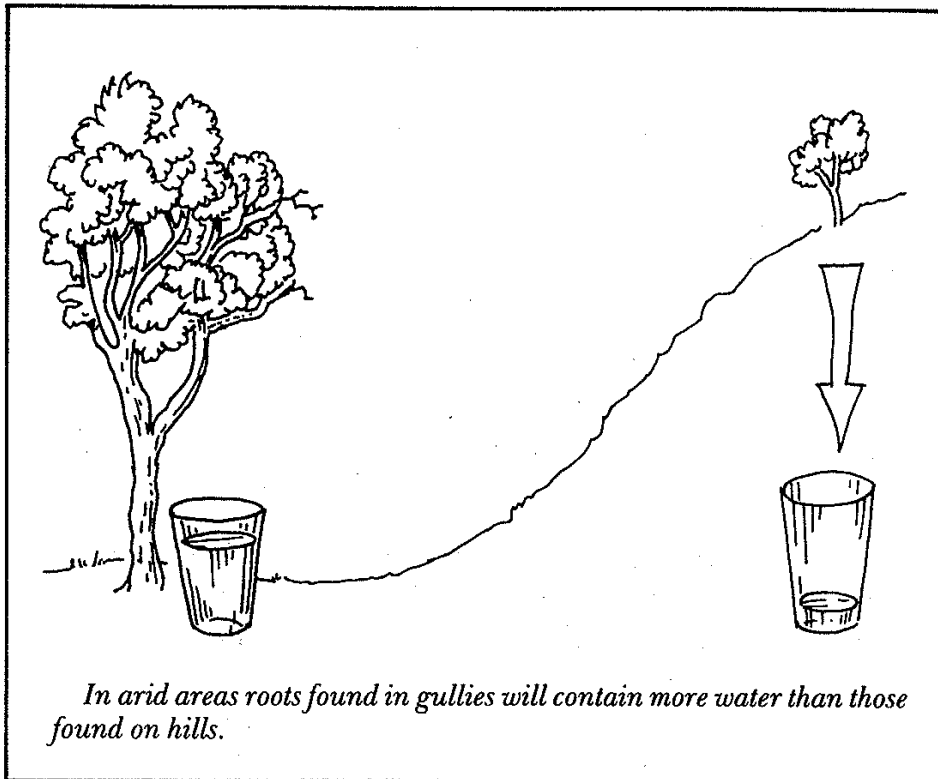

shrubs is more plentiful from vegetation in gullies rather than on high ridges.

In absolutely tree-barren areas it is at times possible to collect water at dawn from dew on the grass. Several of the early European explorers made use of this technique.

One of the easiest ways is to tie tufts of fine grass around the ankles and walk through the grass or other low growing plants just before the sun has risen. Every so often the tuft leggings should be removed and the moisture collected squeezed into a container.

On the sea coast fresh water can usually be found by digging behind the windblown sandhills which still back up to many ocean beaches. The sandhills trap the rainwater behind them and it will 'float' on top of the heavier salt water which filters in from the ocean.

Sandhill wells should only be deep enough to uncover the top few centimetres or so of the fresh water. If dug deeper salt water will flood in and pollute the top fresh layer.

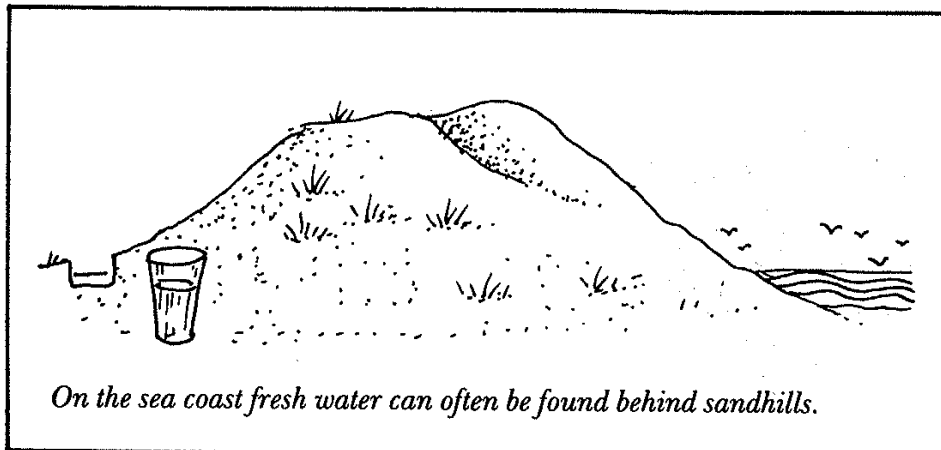

In areas where the sandhills have not been disturbed by recent beach mining they can be regarded as a reliable source of water. Once a well has been dug it is necessary to shore up the sides with driftwood otherwise the natural sand drift will soon bury the well.

The depth of digging with those wells varies. Normally one strikes water at about 1 metre. At other times it may be up to 3 metres. If digging deep the hole should be shored up as digging progresses.

Freshwater soaks may sometimes be discovered on the seaward side of sandstone coastal cliffs. These are usually

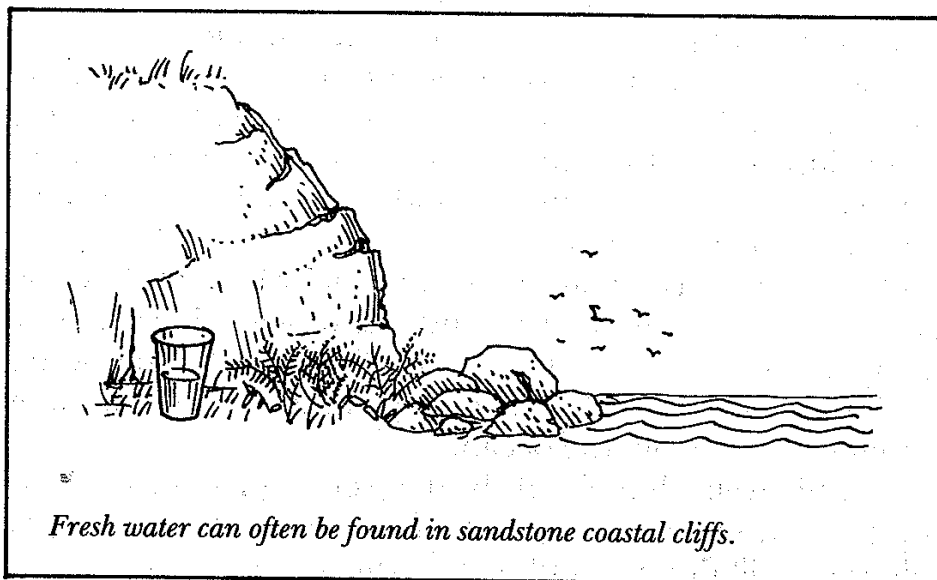

indicated by a fault or crack in the face of the cliff, plus a profusion of ferns and mosses.

Along the sea coast, it is possible without too much equipment to condense seawater. If you have a billy, fill it with seawater and light a brisk fire under it. When it boils hold a dry towel, shirt or any other piece of salt-free clothing over the steam. It will soon become saturated. Once it is saturated it can be wrung out into another container. The process is laborious, but by repetition at least some drinkable water will be obtained.

THE ARIZONA SURVIVAL STILL This method of obtaining water in any area (although it is directed at arid areas) was first devised by the Water Conservation Laboratory in Arizona, USA.

The area for obtaining water cannot be total desert. It must have at least some greenery growing in it.

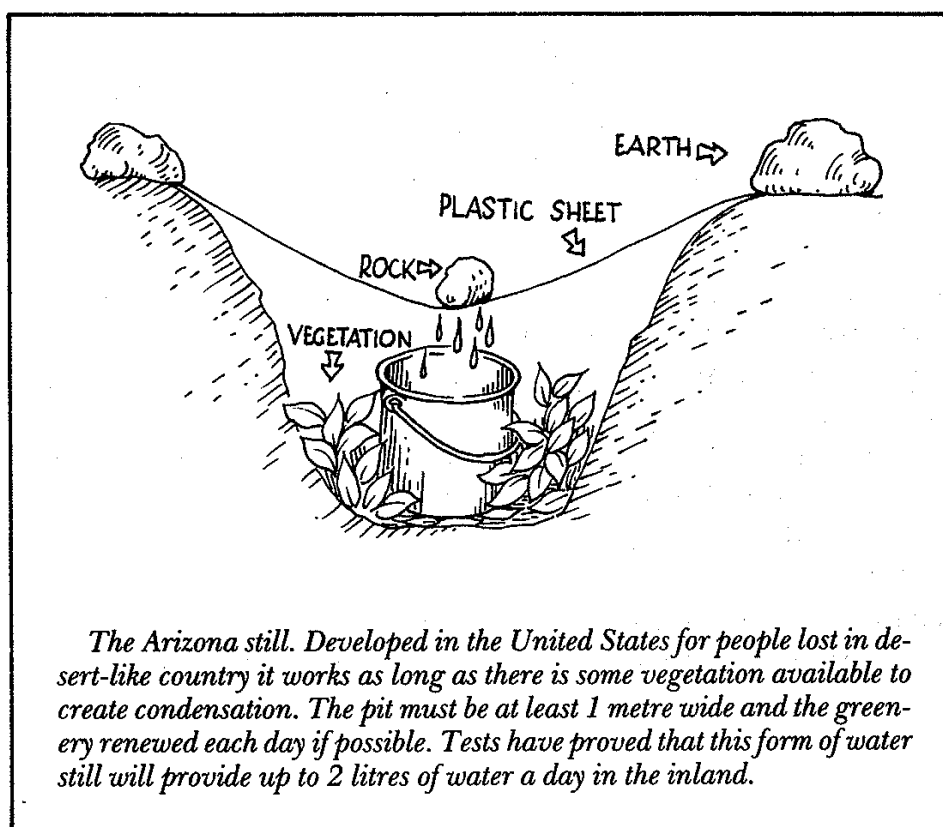

Dig a hole about 1 metre wide and 50-100 cm deep in a position in full sun. Place a billy or other water holding container in the middle of this hole. Around the container any green leafy material should be packed down very tightly; the tighter the better.

A groundsheet should then be placed over the hole and secured all around by stones or soil or both. It should, however, not be absolutely taut.

Place a stone in the sheet so that the dip is exactly above the centre of the water container.

The moisture in the soil and in the greenery placed in the hole will be drawn off by the heat of the sun during the day and condense on the underside of the plastic during the night. This moisture will run down the slope of the plastic and collect in the billy or other container.

If the underside of the plastic groundsheet is slightly roughened before being placed in position droplet collection will be more efficient.

Body waste, such as urine, can also be directed into the hole — but obviously along its sides. In ideal conditions perhaps 2 litres of liquid a day can be collected by such a still, but 1 litre is more usual. If possible the greenery should be replaced every day.

STAGNANT WATER Although all walkers and campers should carry water purification tablets with them as a matter of course, stagnant or suspect water can be made reasonably safe by other means.

It can be filtered through any sort of cloth to remove solids and then boiled. It can also be filtered through a container of charcoal and wood ash.

If it is very muddy a pinch of alum will precipitate the soil particles and the clear water can be taken off from the top of the container. This process will take about 12 hours.

6 Fire making

The ability to make fire is essential in the bush. Fire can provide warmth, comfort and protection. It is essential for the preparation of food because heat, in one form or another, chemically affects the cells of plant foods, making some yield their nourishment and others release their toxic elements.

It also enables the bushwalker to cook flesh, either wild or domestic, and preserve it by smoking or drying. It also can make polluted water safe and drinkable.

The ability to obtain fire under any conditions, provided that combustible material is available, is one of the first essentials of outdoor living.

Making a fire by traditional methods, such as friction, is not easy. But when this skill has been mastered it can give one confidence in difficult situations.

The most sensible way to avoid being caught without the means of making a fire in the bush is to carry modern firemaking equipment with you. As far as the bushwalker is concerned one of the best inventions of recent years is the disposable gas cigarette lighter. Not only are they lightweight and cheap but for added convenience they are often sold in pairs enclosed in a more or less waterproof plastic film.

Each member of a bushwalking party should carry at least one of these convenience packs as a matter of routine, as well as matches. Even if these lighters do get soaked through, unlike matches, given a few minutes to dry out, they will produce a flame.

To give an idea of the toughness of these disposable lighters a New Zealand-made Bic lighter, which was nearing the

end of its useful life, was immersed in water for 1, then 4 and then 24 hours. After 10 minutes drying out in a bleak winter sun it lit without trouble, although after 24 hours it took six flicks to get going.

For emergency use matches themselves should be carried in small watertight containers even if they are the commercial 'waterproof' variety. These can be either of plastic, aluminium or tin — anything that is truly waterproof.

Extras for starting fires can also include solid fuel tablets (the ones used for starting backyard barbecues), candle stubs or a collection of birthday cake candles, also sealed in a waterproof container.

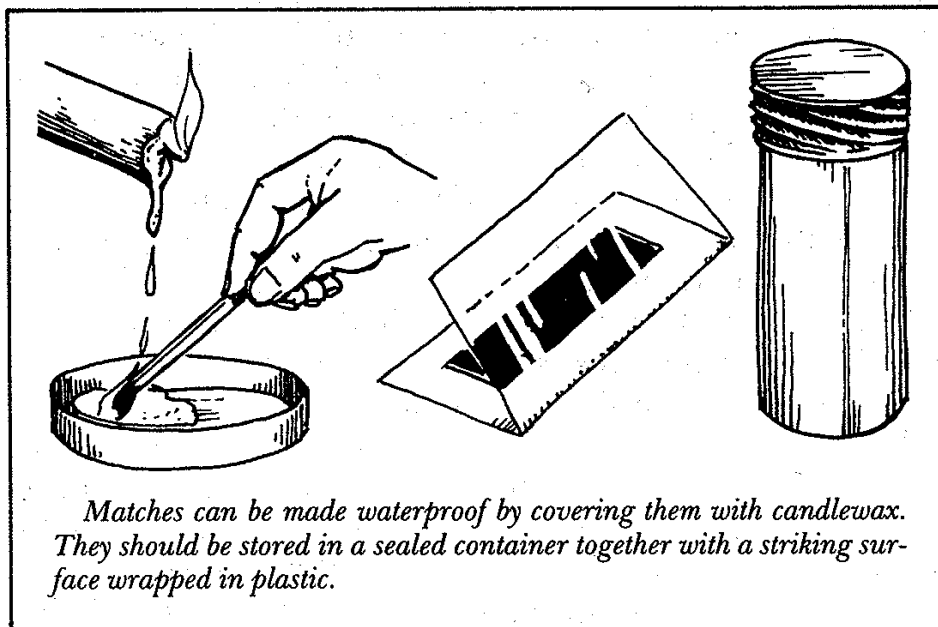

Matches can be made waterproof by covering them with candlewax. They should be stored in a sealed container together with a striking surface wrapped in plastic.

Ordinary matches can be waterproofed before the start of any journey by dipping them in melted candlewax.

If you take all of these emergency fire starters along on the trek, you will find that it is almost impossible not to light a fire, no matter what the circumstances or how bad the weather.

And with two or more people travelling together it would take an almost total catastrophe for the whole lot to be lost at once.

Even so there are correct and incorrect ways to go about lighting a fire.

The correct way to light a fire

Although everyone these days seems to take newspaper as tinder for a fire more or less for granted (and given our bush litter problem this is not surprising), sometimes it just isn't available.

Added to that, the wood may be damp and it may be raining heavily or be very windy.

Unless the weather is very dry and has been so for days on end do not collect kindling wood from the ground. It will certainly be damp and in the morning after heavy dew, wood picked up from the ground will be far too wet to light.

Get into the habit of collecting thin, dead twigs, no thicker than a match, which can be found on almost every shrub.

Gather a big handful of these and, to start the fire, hold the bundle in your hand and apply the flame of the match to the twigs at the end of the bundle (which should look more or less like a miniature straw broom). They should

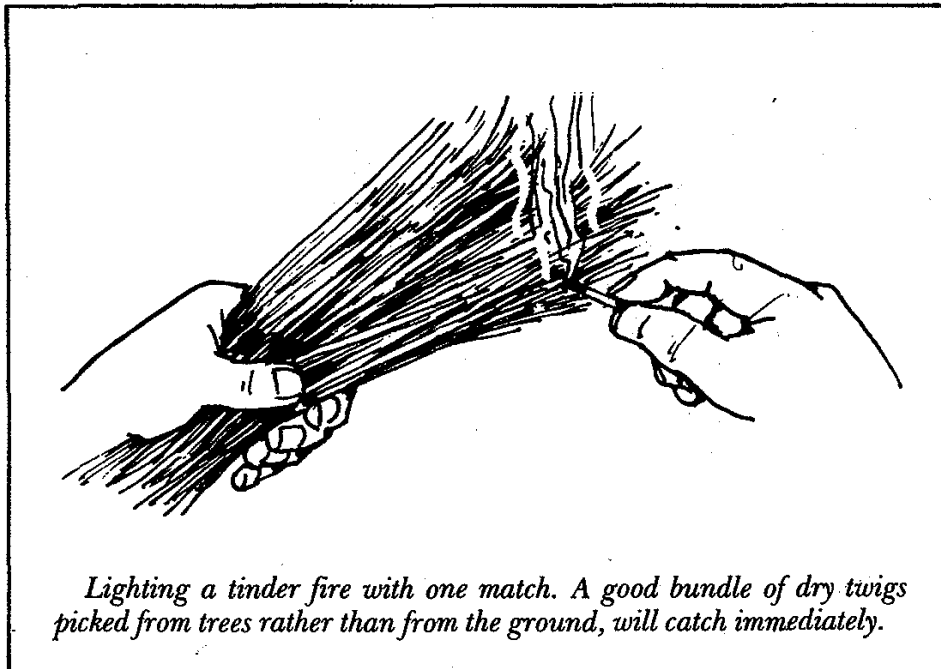

catch fire instantly. Turn the bundle in your hand until all the twigs are well alight.

Then lay the blazing bundle of twigs in the fireplace and feed other small twigs on top, gradually increasing the size until the fire has built itself up to an adequate blaze. Dead eucalypt leaves on branches of three also make excellent stage-two fire builders because of their volatile oils. A good secondary blaze of these, even in very wet conditions, will keep the fire going until damp wood has dried out enough to catch.

As described in Chapter 4, Campcraft, when conditions are so wet that not even your twig bundle will catch, fire sticks can be made by shaving thick sticks — after first removing the outer wet wood with a knife — so that they 'fuzz'. About four to six of these firesticks will be needed to start a small blaze.

In strong wind or heavy rain light these fire sticks under shelter (normally a tent) and once alight carry them to the fireplace in a billy carried on its side.

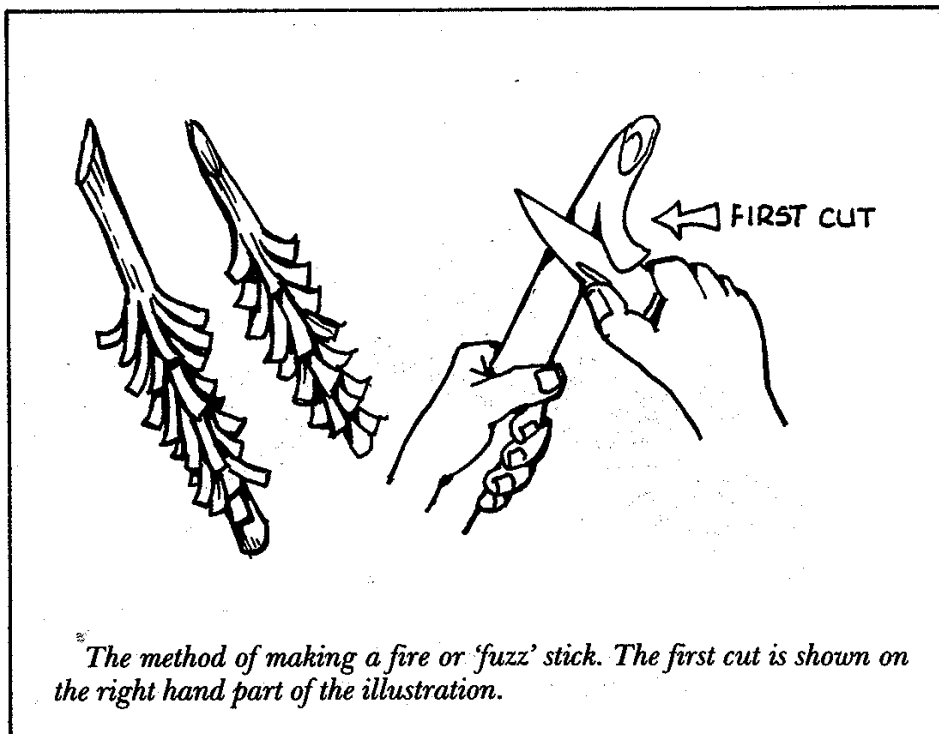

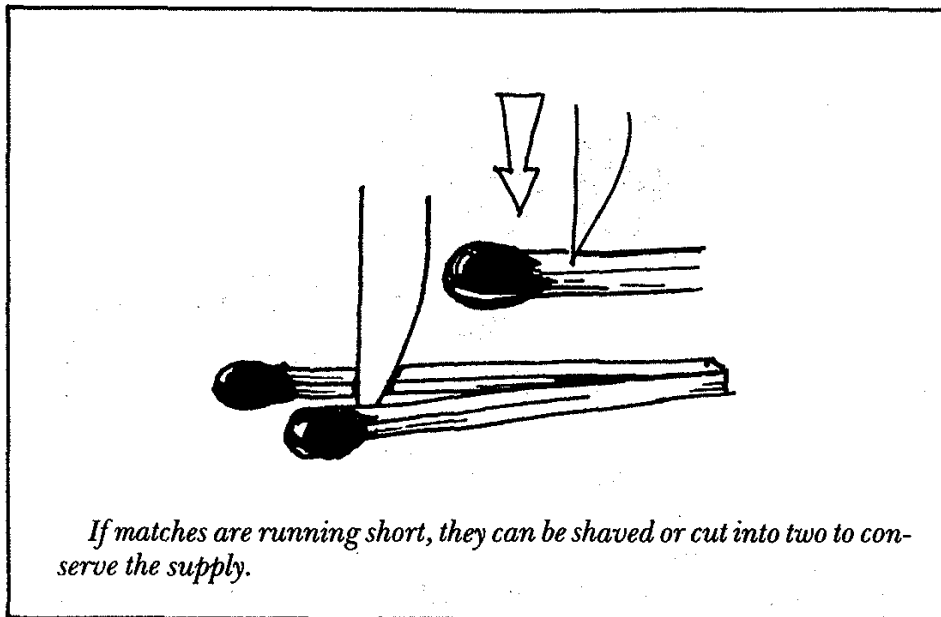

STRETCHING YOUR MATCH SUPPLY If your match supply is running short one can be made to do the work of two with a little care by splitting it.

To split a wooden match push the point of a pin or a very thin sharp knife immediately below the head and force down sharply. The head *should* split in two and the wood run off or split. You will then have two heads and enough wood left on each to burn for a second or more, long enough to catch tinder.

Paper matches can be halved by peeling the cardboard from the end away from the head. It is then peeled towards the head of the match which will usually split away cleanly.

In striking split matches the stalk should be held between thumb and forefinger with the tip of the middle finger resting lightly on the head. The match end is then drawn lightly and flat along the striking surface of the matchbox. Immediately the head starts to burn the forefinger is removed and it is allowed to flame up.

It requires practice to be certain that you can always split your match and strike both portions.

Teasing out a fire from one of these half matches requires some care. Select the thinnest twigs possible, together with

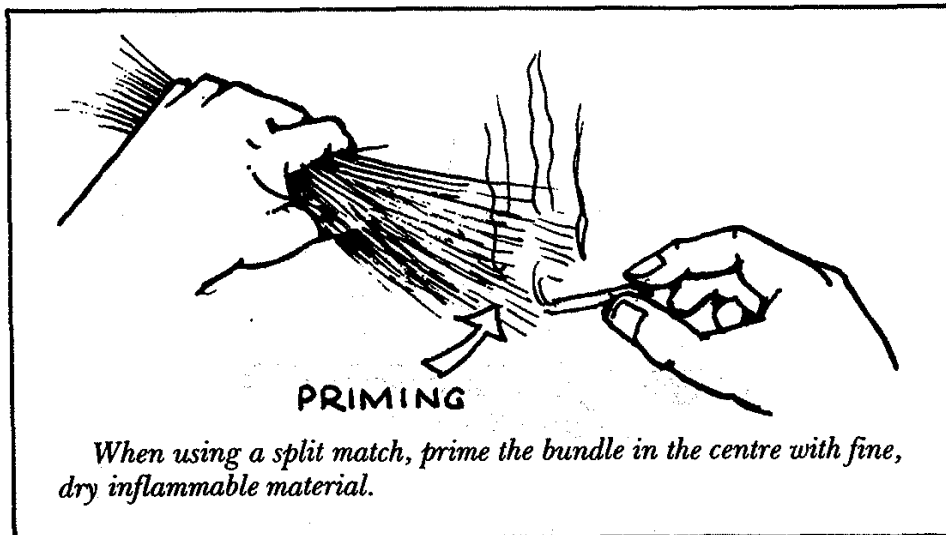

some teased out very dry bark fibres, dried grass or in fact anything or any material that is bone dry and extremely fine.

Do not pack this bundle tightly or it will snuff out the tiny flame from the half match. If the fine inner material catches with some speed you will have succeeded as this inner core will soon generate enough heat to flare the twigs.

A word of warning: learning how to successfully light a fire with half a match will undoubtedly lead to a number of scorched fingertips. This is something you have to learn to live with. In an emergency this slight difficulty will hardly matter.

LIGHTING A FIRE FROM A COAL A fire can be started from a small red coal from the previous day or night's site. But starting one from a coal that may be no bigger than the half pinched out spark of a cigarette requires some skill.

Collect a bundle of dry tinder such as grass, very dry and teased out inner bark, or other suitable material, and place the coal very carefully in the centre of it. Fold the rest of the tinder over the coal, making it into the shape of a rough ball. Then, holding it very loosely in your fingers whirl it round and round at arm's length, or, if there is a strong wind blowing, hold it up in the air allowing its full force to blow right through the mass.

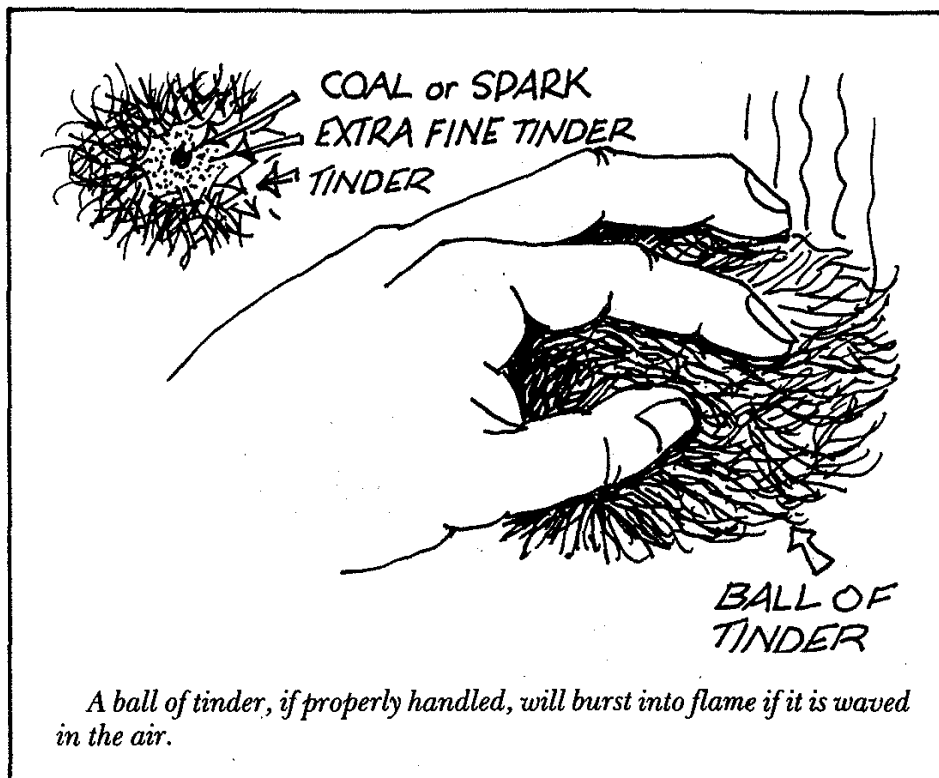

As the tinder starts to catch the ball will start to smoke. When there is a dense flow of smoke blow into the ball teasing it out a little further. This blowing should cause it to flame. It should be immediately placed under a bundle of prepared fine twigs.

SMOKELESS FIRES In a very restricted campsite or in a cave or other natural shelter it can be an advantage to know how to build a fire that gives off almost no smoke and also one in which the flames are not large.

Smoke is the result of incomplete combustion. By ensuring that the combustion is almost total the volume of smoke will be reduced to next to nothing. By feeding a fire continuously with small twigs it will be nearly all flame and smoke will be kept to a minimum.

If you light the fire under a tree — but not against its trunk — the leaves and branches will completely filter out what smoke is produced.

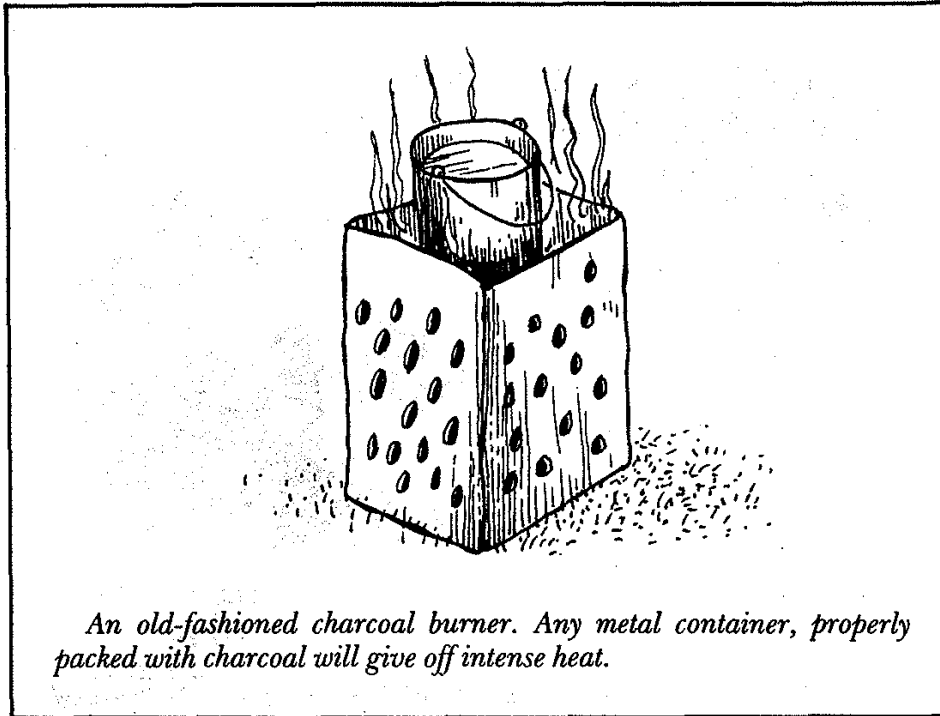

Fire 'without flame' is produced by lighting in the normal manner. It is then fed with small lumps of charcoal previously gathered from burnt out stumps and trees. There is usually an abundance of this material in most bush areas because of our more or less regular bushfires.

To get this charcoal moving it may be necessary to fan it continuously for some time to get it glowing but not flaming. A charcoal fire needs a lot of air but gives out great heat once established.

An old tin or drum pierced with holes makes a good container for a charcoal fire. Failing this, it can be built within a circular round of stones with plenty of air-hole chinks all around the edges. This stone surround will not give out quite as much heat as the metal container but it still works well.

Firewood

Finding suitable wood for cooking and campfires is basically a matter of selecting the best material in your immediate

area. No bushwalker, after all, lugs firewood around more than he or she has to.

Some form of eucalypt is found all over the country and dead branches of any one of this large species usually make an excellent fire. But there are grades of excellence within the various eucalypts. It is generally conceded that any of the boxes, yellow or grey, the large number of slightly different trees commonly called ironbark, red gum and mallee make the best burning. These are followed by the stringybarks with high altitude eucalypts, such as the snow gum, coming up in the rear.

The coastal and inland angophoras, commonly called 'apples' tend to burn less well and throw out a good deal of smoke. The acacias (wattles) make good firewood if very dry and the large banksias are passable.

The introduced pines also provide good firewood. But as they are almost entirely confined to government or private plantations there is little chance of getting hold of any of them for firewood. However, if camped near a plantation the fallen cones can be gathered. They burn excellently.

All rainforest and swamp country trees generally make indifferent firewood and some species, even if very dry, will not burn at all.

A basic rule is that the softer or 'pulpier' the wood, the more inferior the fire.

Unless one regards it as some part of a training course, cutting and splitting of firewood can generally be avoided. It is a laborious chore and adds little to the enjoyment of a bush outing.

Once a fire has been established with small wood which has either been snapped or broken across one's knee, larger logs can be burnt in half and then fed into the fire by shifting them into the flame as the ends turn into coals. A reasonably wide fireplace is needed if using this method otherwise the cook will be continually tripping over the logs.

But wood can be split if necessary. When splitting with an axe, the best results are obtained by driving the blade into the block and then raising both axe and wood in one motion.

By reversing the axe head in the air and bringing the head down with the wood uppermost the block will generally be split.

Fire without matches

Apart from the drill and spindle method of starting a fire without matches, most of the other devices described in this section are of purely 'historical' interest. They are instructive as tests of one's ability. But it should be pointed out that almost all of them require great skill and a great amount of practice. It cannot be assumed that any one of them is going to work at the first attempt.

In past centuries many ingenious methods were used to both make and preserve fire. Some that still survive in certain communities include the bow drill, flint and steel, and an air compression chamber. In addition to these methods fire can also be created by using a magnifying glass.

And there are of course many others, a number of which have been forgotten. One interesting way to start a fire, as a home experiment only one should add, is the creation of an 'instant' flame using ordinary sugar and permanganate of potash (Condy's crystals).

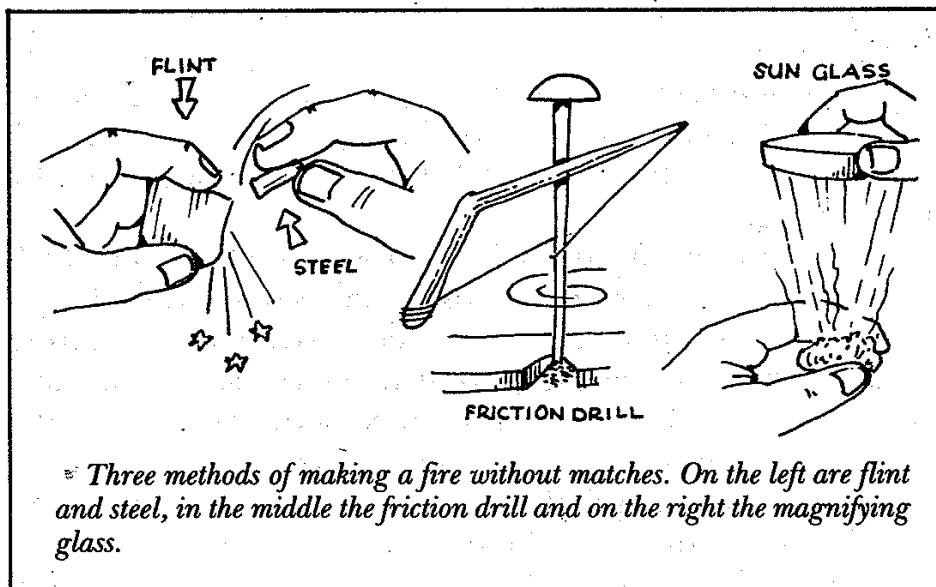

Take about one teaspoon of sugar and about half a teaspoon of Condy's crystals. Mix them together and place them in a hollow cut in a piece of very dry wood. It should be big enough to entirely contain the mixture.

Cut a straight thin stick about 30 cm long so that it has a rather shallow point. Place the pointed end of the stick in the powder and rotate it rapidly between the palms of the hands.

The mixture should burst into a slow flame. Several attempts may be necessary before ignition point is reached.

This small experiment is merely designed to show that flame can come from many sources.

TINDER While tinder is important for starting any fire it is absolutely essential for starting one without the aid of matches.

To be suitable it must be readily combustible and finely fibred. A simple test of the material in its natural (that is to say, unprepared) state must be made to discover what materials at hand are best. Take a loosely teased handful of fibre, place a small coal in it and blow. If the fire from the coal quickly extends to it and it starts smouldering then it is suitable.

Dry beaten grass, finely teased bark and palm fibre are the materials generally sought out. All three are improved in their ability to 'catch' a spark by being beaten until their fibres are very fine and soft.

The natural properties of any tinder can also be improved by a light dusting of very finely ground charcoal or, better still, by being thoroughly scorched.

An old method of improving tinder used to be to soak it in a solution of saltpetre (potassium nitrate) for several hours. It was then allowed to dry out and packed into an airtight container. Saltpetre, apart from being used in the salting of meat, was an essential ingredient in gunpowder. This type of tinder was invariably made from teased out cotton or linen rag.

These teased cotton or linen fibres were then often spun into a cord (after the saltpetre impregnation) and one end

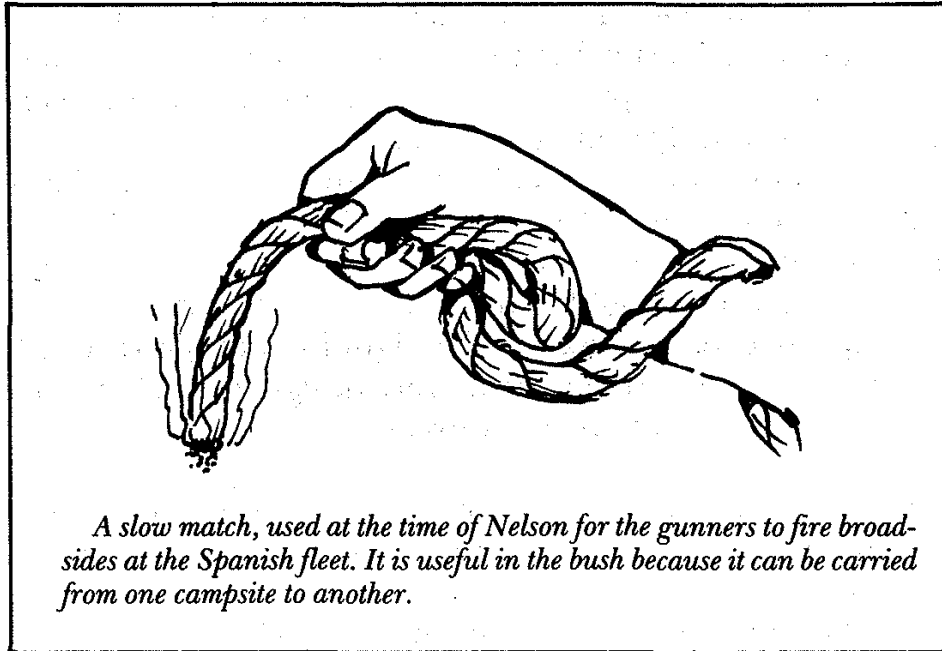

was lit. It was called a 'slow match'. These slow matches were carried by troops into battle in the days of breech loading guns and used to ignite the initial flash powder that fired the implement.

FIRE FROM A SPARK The use of flint and steel was the common method of lighting a fire before friction matches were perfected. No great skill is needed for their use.

The synthetic flint used in a cigarette lighter, in this regard, is an improvement on the natural product. A couple of pieces of synthetic flint embedded or glued to a hard surface make an excellent emergency firelighting outfit.

An alternative to flint and steel are two pieces of iron pyrites which, when struck together, will throw off a shower of sparks that will last for about a second. Iron pyrites and steel will also throw a hot spark. Quartz and steel or two pieces of quartz will also throw sparks. However, it is quite difficult to produce these sparks just using the quartz by itself.

The sparks must fall downwards onto the tinder, which must be blown into a coal and from this to a flame. Only a

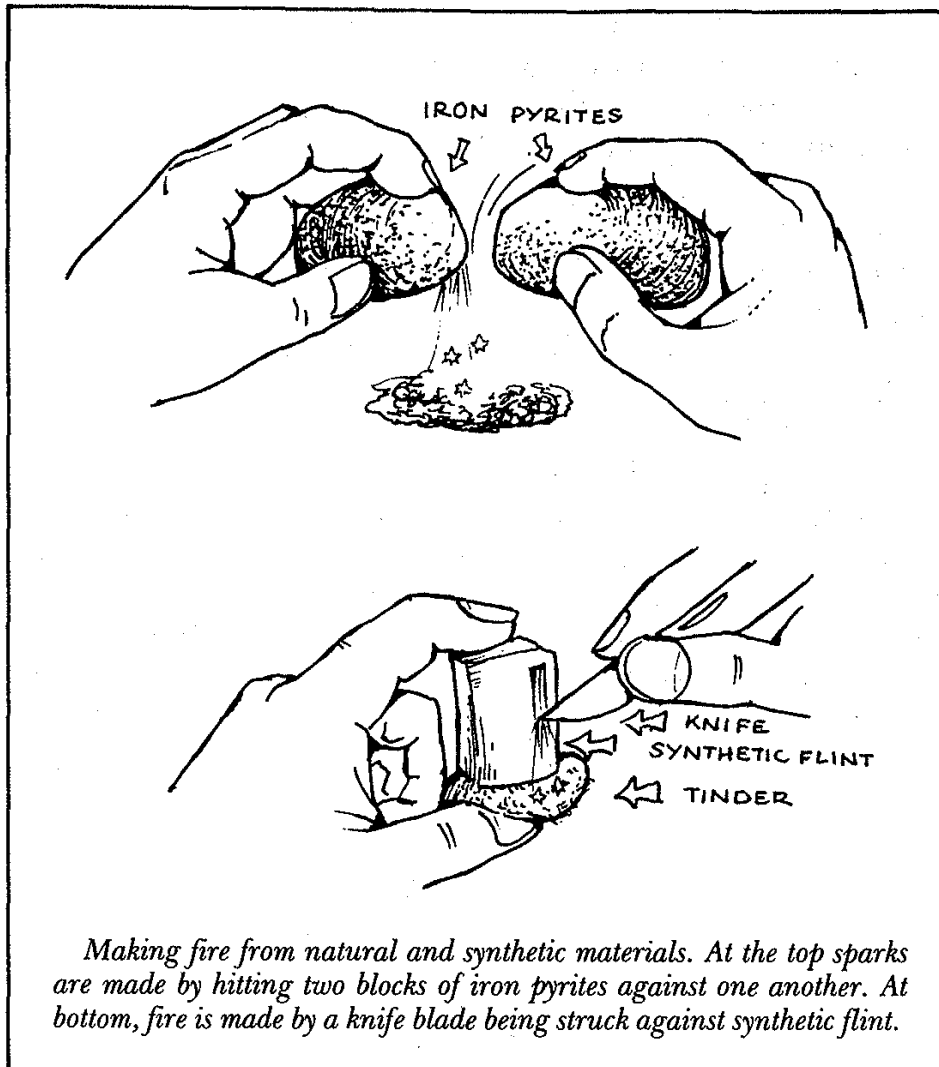

Making fire from natural and synthetic materials. At the top sparks are made by hitting two blocks of iron pyrites against one another. At bottom, fire is made by a knife blade being struck against synthetic flint.

pinch of tinder is necessary when you become expert at starting a fire in this manner.

FIRE FROM A MAGNIFYING GLASS Almost everyone at some time or another has focused the sun's rays by concentrating a magnifying glass on a piece of paper or cloth to make it brown and then start to smoke.

When using a magnifying glass to start a fire simply substitute a ball of tinder for the paper. When it starts to smoke freely blow it into a flame. Powdered charcoal at the focal point of the glass will help the tinder take more easily.

FIRE BY FRICTION Firelighting by friction consists first in generating a spark or tiny coal and then nursing this in tinder until a flame is obtained.

It is most easily mastered by rotating a wooden drill or spindle in a footpiece by means of a bow. In some methods a bow is not used but the spindle is merely rotated very quickly between the palms of the hands. This requires considerable skill.

The components of the bow fire drill are a headpiece, a drill, a footpiece and the bow itself. Assembled it is called a fireset.

To use it the drill is put under the thong and twisted so that it lies on the outer side of it. The portion of the thong nearest the handle should be on the upper side of the drill. This is important because if the thong is the wrong way on the drill it will cross over itself and cut in a few strokes. Added to this, it will be impossible to get a full length stroke.

The footpiece has a shallow hole cut with a knife point into

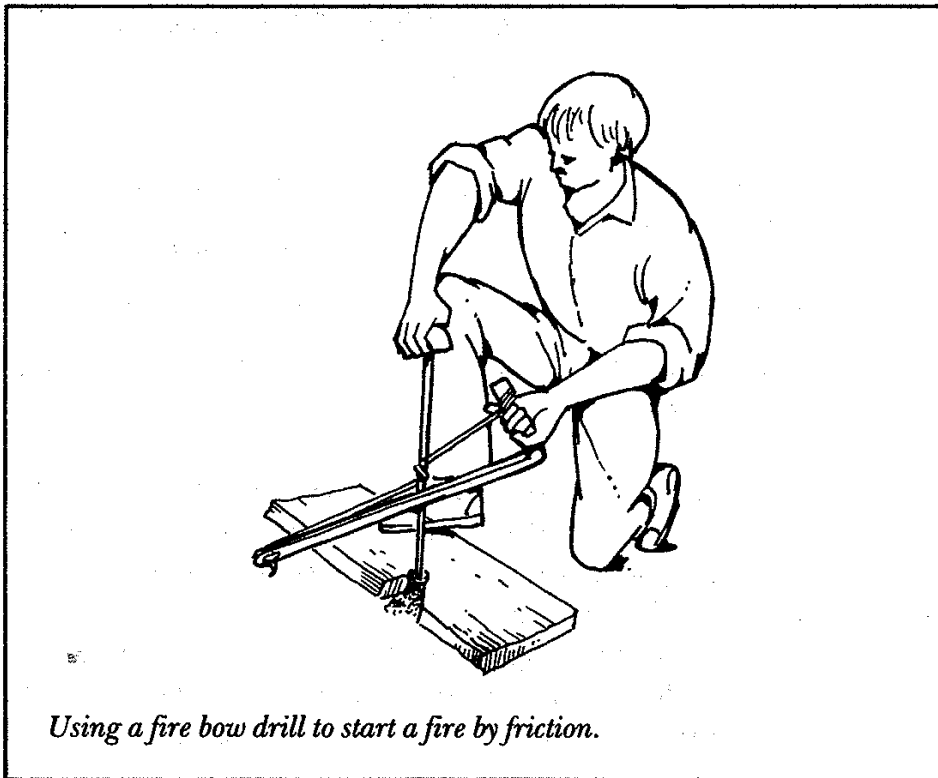

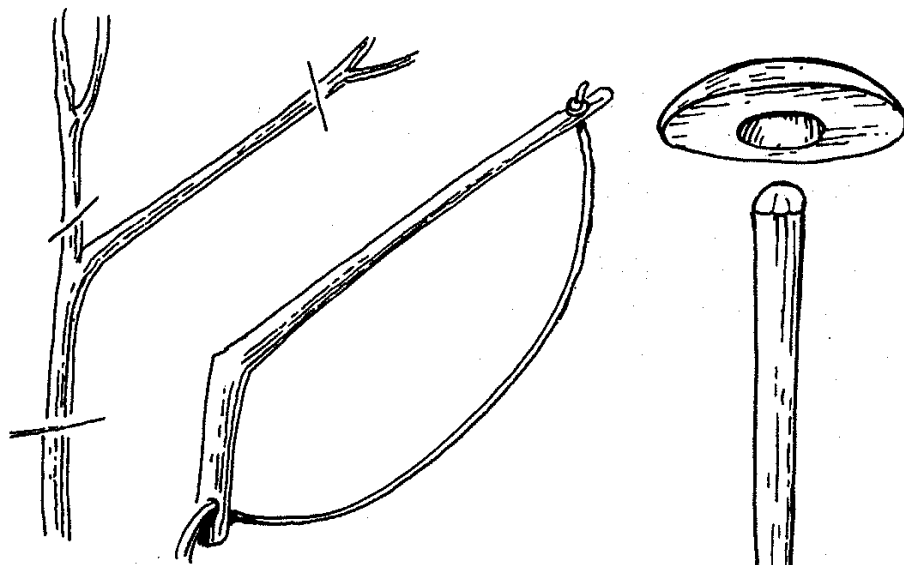

DRILL

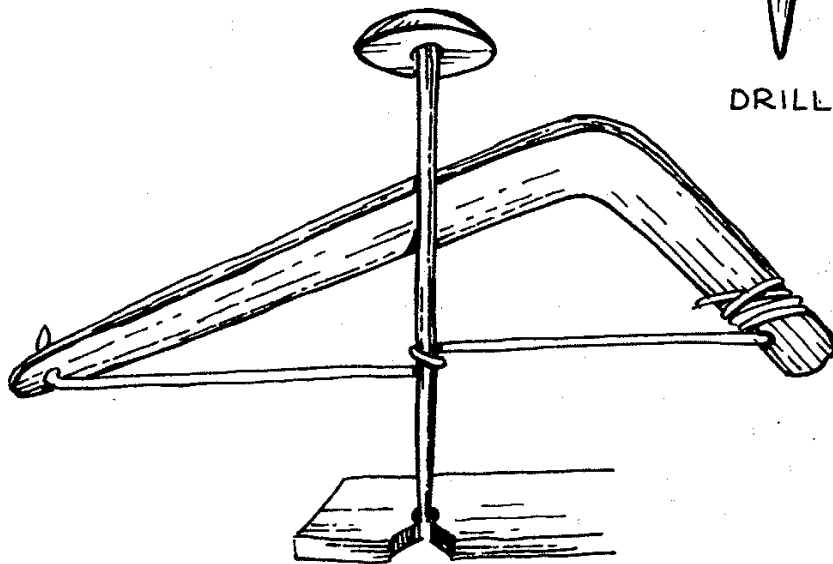

FOOT PIECE

The construction of a fire bow drill, showing the bow, headpiece, drill and foot piece. The bow must be cut from a young sapling or a piece of dead wood. The thong should come from a leather bootlace or a piece of greenhide. The assembled drill is correct for a right-handed person.

the upper side about 10 mm from one edge. In this hole the drill is rotated. At the edge of the hole a V cut is made. This V should extend at least 5 mm into the hole itself.

The underside of the headpiece has a shallow hole bored into it. This is lubricated preferably with the graphite from a lead pencil. Failing this a smear of fat, or even wax from one's ear, will do.

The correct body position for using the bow and drill is to kneel on the right knee with the ball of the left foot on the base plate or footpiece to hold it firm.

Place the lower end of the drill in the hole in the footpiece and the top end of the drill in the underside of the headpiece.

Assuming, of course, that the operator is right handed, the left hand holds the headpiece. The wrist of the left hand must be braced against the shin of the left leg. This enables the operator to hold the headpiece perfectly steady. The headpiece, in fact, is a bearing for the drill.

The bow is held in the right hand with the little and third finger outside the thong so that, by squeezing these two fingers, the tension of the thong can be increased.

When starting with a firebow for the first time it is advisable to rotate the drill slowly to get the feel. Gradually increase the rate of strokes to spin the drill faster.

If the firebow is being worked correctly smoke should be seen coming from the footpiece. The operator will also notice that a fine brown powder is being formed. It should start to form a dark ring around the hole. This powder is called punk.

If the operator now stops and examines this punk he or she will discover whether the woods chosen are suitable for the task. The punk, which will eventually produce a glowing red coal, must feel slightly gritty when rubbed between the fingers. With more rubbing it soon becomes as fine as face powder.

When the operator considers that he or she has mastered the operation of the bow and drill the next step is to attempt to produce fire.

Place a generous bundle of tinder under the V cut. When the drill is smoking freely and the punk is grinding out easily and the V cut begins to almost fill, put extra pressure on the headpiece. At the same time make 20 or 30 faster strokes with the bow. Lift the drill quickly and cleanly from the foot-piece, fold some of the tinder over lightly and blow gently into the V cut.

If you see a blue thread of smoke rising you can be sure you have a coal. You may even be able to see it glowing. Fold the tinder completely over the footpiece and continue blowing into it. The volume of smoke should increase until the coal finally bursts into flame.

Some people who have had great success with the firebow state that efficiency is increased and the success rate is higher if a little charcoal or gritty material is placed in the drill hole. They say that more punk is ground out and a spark will be obtained more quickly by doing this.

Very good firebow sets can be made from dry willow and some of the non-resinous native pines.

Refinements can be made to the basic firebow set. These include boring or burning holes for the thong at the tip and through the handle. The end of the thong at the tip of the bow has a thumb knot tied to its top side. The hole through the handle takes the long end of the thong. This is then wound around the handle in a series of half hitches. This enables the operator to adjust the tension with greater accuracy.

Likewise a headpiece of shell or smooth-grained stone with a shallow indentation in it is less liable to burn than a headpiece made of wood.

FIRE BY COMPRESSION Many people in parts of South-East Asia used to make fire by using a compression cylinder.

When a plunger is suddenly rammed down hard within a cylinder onto a piece of tinder the air temperature within the tube rises sharply. This rise is sufficient to light a piece of tinder.

Fire-making sets were usually made from a cylinder of

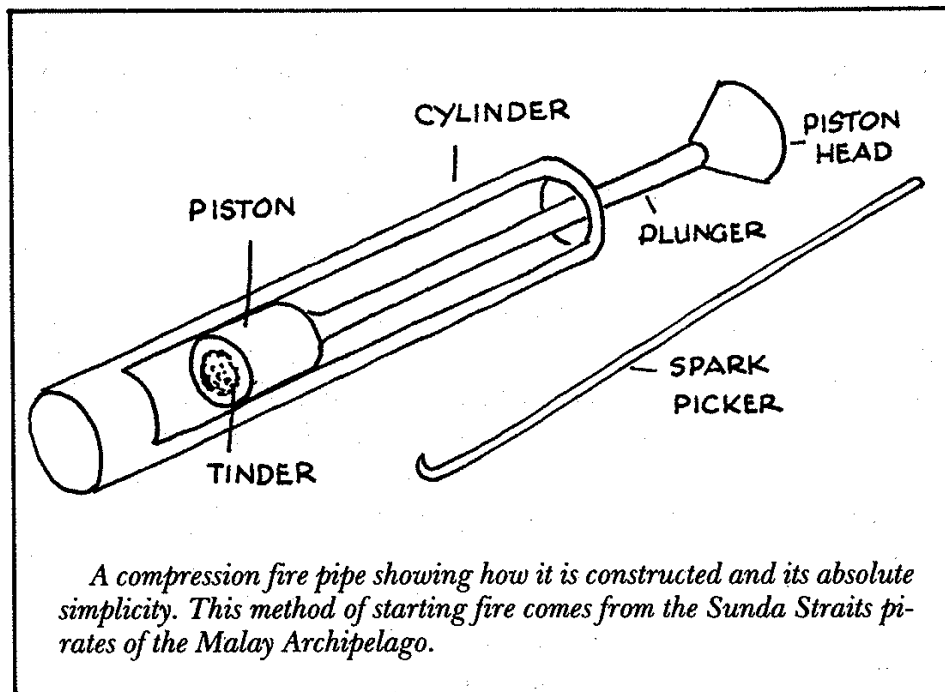

bone or hollow bamboo with either a bone or a wooden piston. To use the device a small piece of tinder is inserted into a cavity in the lower end of the piston. The piston is then placed in the cylinder and the flattened top head struck a sharp blow with the palm of the hand. This drives it suddenly down the cylinder. The compression and subsequent rise in air temperature usually creates a small, glowing coal in the tinder.

Frequently the jar of the blow will shake the tinder loose so a 'spark remover' is used to extract it.

The dimensions of one of these sparking sets are roughly as follows.

Cylinder: 10-15 cm long; outside diameter, 2.5 cm; inside diameter, 1-2 cm.

Piston: 10-15 cm long of which the shaft is between 8-12 cm.

Piston length: 2-2.5 cm. Diameter is inexact but it should fit snugly inside the cylinder while allowing free movement.

Recess at lower end of piston about 5 mm wide by 5 mm to 7 mm deep.

Piston shaft end is smooth with a small striking surface cap about 3 cm or so across — wide enough to take a hard blow with the flat of the hand.

Fires for all occasions

There is a saying among experienced bushwalkers which goes, 'The bigger the fire the bigger the fool.' It is a remark well worth remembering.

There are several other points about lighting fires in bush country which should be remembered. A fire should never be lit at the foot of a standing tree. Never light a fire that you cannot control. Never leave a fire burning when you leave camp. Always light any sort of fire on clear, brushed ground. Do not build it on litter, whether it is woodland leaf piles or areas of dried grass. A sudden gust of wind can throw sparks into this litter and this in turn can quickly flare up and get out of control. As a general rule, even a small fire for a single billy should sit in the middle of a cleared area about 2 metres across.

Campers and walkers should also remember that during summer at the height of the bushfire danger season both State government and local authorities can impose total fire bans. These bans normally extend from 6.00 a.m. to 9.00 p.m. During these hours no open fire of any sort can be lit for any purpose whatsoever. Campers and walkers are advised when considering camping at the height of summer to find out what regulations are in force in their area.

They should also, if walking in national park areas, take note of the fire danger indicators posted at most major entrance points of these areas. If the indication is 'extreme', even though there is no total ban, extreme care should be taken in handling any sort of campfire. It should be thoroughly enclosed by stones or a dirt wall and it should not be allowed to burn through the night. Avoid using material that sends up showers of sparks. Keep a billy of water handy at all times for damping a fire down under these circumstances.

Various types of cooking fires and fires for difficult condi-

tions have been covered in detail in Chapter 4, Campcraft. But there are as many different approaches to fires and firemaking as there are campers. The following are a few for different purposes that the author has found useful.

FIRES FOR WARMTH If caught out at night without sleeping bags or any bedding whatsoever, select the site for your fire against a dead log, having made sure that it is not a hiding place for snakes.

A single log will rarely burn by itself unless there is a strong draught blowing directly into it. Therefore to keep it alight, it must be fed with at least one other log. This can be done by selecting a solid, fairly long branch about 20 cm thick if possible. Build a fire against the larger log already in position and then drag the point of the smaller branch into this fire. As the smaller log burns down during the night it can be pushed forward into the fire.

Alternatively, lay a number of logs in the shape of a star and push the ends of each together from time to time to keep up the strength of the fire. A small log pushed against a dead

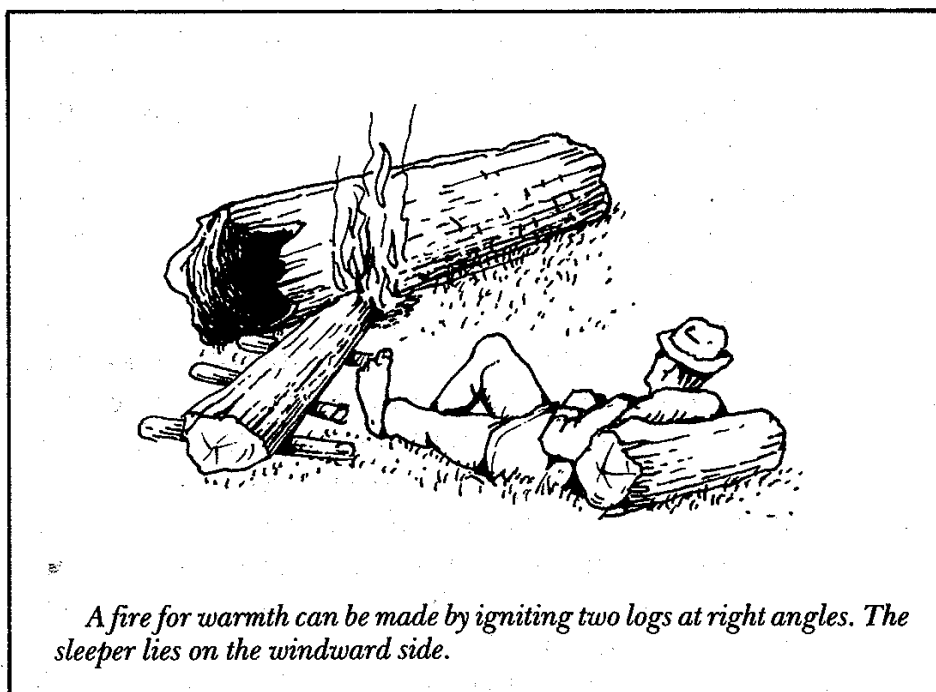

fallen tree will give adequate warmth on a cold night. But great care must be taken the next day to make sure that it is completely out.

OTHER PROTECTIVE FIRES A solid log wall with an interior pyramid will provide an excellent fire for warmth once it is well alight. This is one of the best of all campfires. Three or four logs over 1 metre long are laid side by side and over and across them another three or four. A third layer can be built up if desired. On top of the final layer the starting fire is laid. This is built up like a small pyramid. When this starter fire is

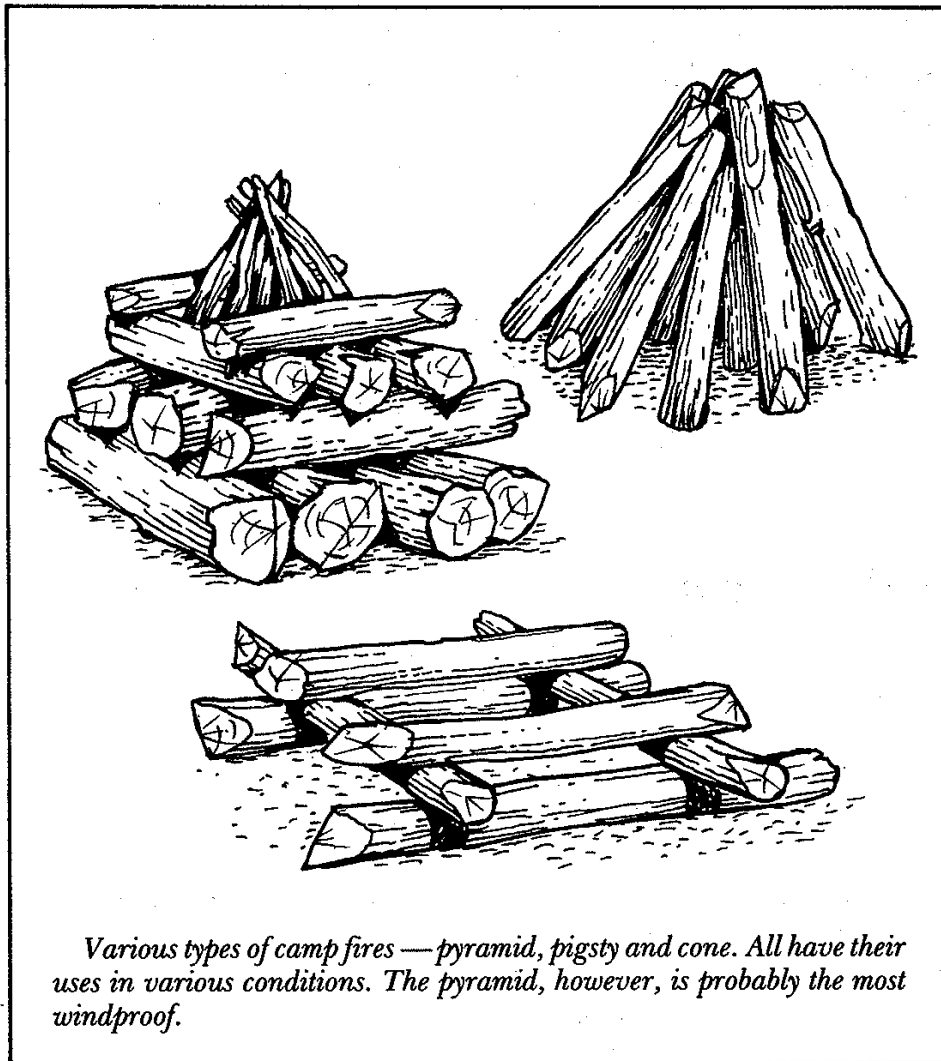

burning it ignites the logs below with falling coals and so burns downwards. It radiates heat evenly all round and requires no attention during the night.

Because there is very little risk of the fire falling in the risk of sparks spreading outwards and starting a bushfire is minimised.

A common mistake in building a campfire is to build a 'pigsty' shaped construction with heavy logs on the outside and the inside packed tightly with brushwood. Such fires are rarely a success. The light wood inside burns out quickly; but the heavy outer logs lack sufficient heat to get them properly alight. All-round heat radiation is also poor.

If the 'pigsty' method is to be used, the top two layers should be completely across the uppermost part of the construction. These two layers, when alight, get plenty of air from below after the brushwood has burnt out. The heat generated will be reflected downwards giving good radiation.

A cone fire often gives excellent results with wet wood or in wet conditions. Stand the logs on their ends and build up the fire in a cone or pyramid shape. Lightly pack the centre with brushwood and other kindling and then fire it. As the core burns away the logs fall inwards, constantly feeding the heart of the fire.

Bushfire sense

If caught in a bushfire the first rule, which can be extremely difficult to remember in times of extreme danger, is to try not to panic.

Try to avoid panic running and run only when necessary. Use every means that will shield you from radiated heat, which is the most dangerous. Take refuge in dugouts, running streams and ponds. Do not however attempt to seek safety in elevated or ordinary water tanks as you will literally boil.

When the smoke is very dense try to limit the breathing. Don't gasp. Even in the worst smoke situations small 'pock-

ets' of clean air puff through from time to time. Remember the air nearest the ground is most likely to contain the least smoke.

If, in the case of a grass fire, you are *forced* to run through the flames, cover all exposed surfaces as best you can, take a few deep breaths to carry you through the worst and from then on *do not hesitate*. Stopping is fatal. Attempt to choose a path that is relatively free of obstacles.

If your clothing catches fire do not run. This merely fans the flames and inflicts severe burns. Beat out the fire if possible with your hands. If a blanket is available wrap yourself in it and roll on the ground. This will generally smother the flames. If you see another person on fire and running in panic hurl them to the ground and beat out the flames with your hands or smother the flames as best you can. You will still get burned even following this advice but the burns are not likely to be fatal.

Under no circumstances attempt to cross flames that are more than a metre and a half high, or more than 10 metres in depth, or that have entered the treetops — known as a crown fire. To do so is likely to be fatal.

If there are no places of refuge, such as waterholes, lie flat on the ground, having covered yourself as best you can, on the barest piece of ground available or in any sort of depression (a culvert, a rut) or behind rocks or logs.

Resist your immediate impulse to run from an encircling fire unless you believe you can outrun it. Fires move at amazing speed. If you decide on this course of action on no account run uphill. Wind conditions in a strong fire force fires to move uphill and they do this at remarkable speed. Attempt to work out an escape route which is downhill.

FIGHTING FIRES A ground fire can be fought by either beating it out or by making a firebreak. If it is purely a grass blaze use green, leafy branches to attack it, beating the front back towards the position already blackened. When bush and low scrub are alight you may be able to control it with branches but wet sacking is far more efficient.

If the fire extends on a long front, too wide for you to attack, or if it is fanned by a high wind, your best defence is to attempt to burn a firebreak between yourselves and the advancing front.

Select a line for the firebreak where the grass or scrub is thinnest. Light a small area at first and force the flames towards the oncoming front. Beat out any that attempt to move back on you. Your firebreak should start to move against the wind towards the oncoming flames in the draught created by the heated air between the fire and your firebreak.

If protecting your camp, extend your firebreak in a wide semicircle around the bushfire side. When the approaching fire reaches the ends of your firebreak be ready to attack it if it starts to burn back against the wind.

A large forest fire is a much more dangerous proposition. There is little that one or two people or a small party can do against such a blaze without professional firefighting equipment. Fires such as these can leap firebreaks over 200 metres wide.

If you know a forest fire is in the area move out as soon as possible, even if it appears to you to be many kilometres away and burning in the opposite direction.

Winds can veer in a matter of hours bringing the fire to your campsite with frightening speed.

As a general rule it is sheer folly to go bushwalking or camping at a time of total fire ban, extreme bushfire danger, or where fires are known to be burning. If you feel you must bushwalk at these times choose half-day or one-day walks. Leave longer treks to the cooler and safer months.

7 Animal habits

The ability to recognise animals in the Australian bush is of enormous benefit to the hiker. Apart from the pleasure of becoming one of a rather select band of people who can tell one bird or mammal from another, species identification (especially with birds) can lead you to waterholes, sources of wild food and in the case of semi-wild cattle, a more or less easy path over a ridge or other natural obstacle.

The ability to identify species also ensures that you stay out of danger. Although Australia possesses no dangerous land mammals it has the dubious distinction of harbouring the world's most venomous snakes and two of the most poisonous spiders. While fatalities are rare, knowing the habits of both snakes and spiders can prevent unnecessary bush accidents.

As has been stressed elsewhere in this book, almost all native animals in Australia are protected and it is an offence to kill them.

Tracks and their meaning

Although it is well-known that the Aborigines, like any hunter-gatherer race, could track almost anything anywhere, centuries of urban civilisation have taken this skill away from most of us. In addition to this, Australia, because of its dryness, is a particularly hard continent to track anything in. On a drought-stricken claypan, almost no animal leaves a discernible mark to the European eye.

Most books on animal tracks and their meaning come from the northern hemisphere. And invariably they show

the tracks of the animal through snow, because winter was the time of the year when fur trappers went in search of their prey and hungry people were looking for something to put into the cooking pot.

To re-use an Australian colloquialism, even Blind Freddy could both identify and then follow the tracks of any animal through snow. Following and identifying tracks of an animal on a saltbed or claypan are a rather different challenge.

There are two easy areas where species can be identified by the tracks they leave however. The first is along a seacoast estuary or surf beach at low tide. The second is at the sides of a billabong, soak, or inland tank.

Certain animals also leave trails that are impossible not to identify. The easiest animal to follow in this respect is the wombat. The wombat is a creature of habit. He doesn't so much make a track from his burrow to his feeding areas — he makes a road, as wide as a cowpath and as much trampled. A wombat trail is unmistakable. One doesn't even have to look for footprints.

Other Australian marsupials, such as the carnivorous pouched mouse, also make roads, although one has to look more closely to spot them.

If one walks through a field of native grass and comes to a bare patch, one can then see tunnels everywhere where the tall grass begins again. One can also see these tunnels in beds of reeds. In areas where there are rotted stumps and logs one can also see digging marks where the echidna or the numbat has searched for a termite dinner.

Signposts (the wombat aside) in the Australian bush are very subtle, like the grey-green of the eucalypts themselves. Early European settlers found great difficulty in understanding this low-key approach of nature. They were used to seeing the red brush of a fox against a field of vivid green. Spotting a grey-green wallaby against an equally grey-green eucalypt was much more difficult. And following the tracks of an animal that hopped was even more difficult. Instead of a 10 cm gap between pug marks one had to learn to follow gaps of up to 2 metres. The early settlers soon redressed the

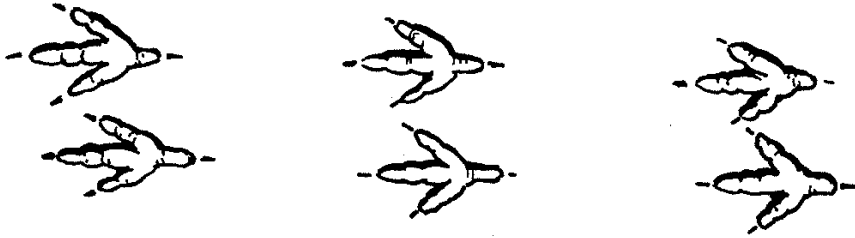

Tracks of a hopping bird. These usually indicate that the bird is not a ground feeder.



Tracks of a walking bird — which indicate that it is a ground feeder.

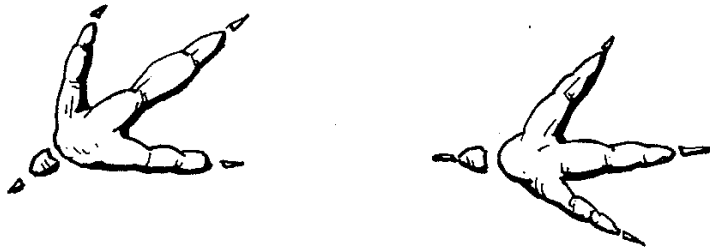

Lack of a back digging claw on the tracks of this bird indicate that it probably is a grain or fruit eater.

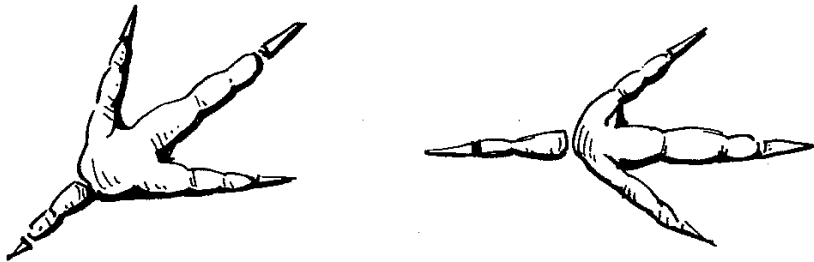

The powerful back claw in the tracks of this bird indicates that it is a digger or scratcher.

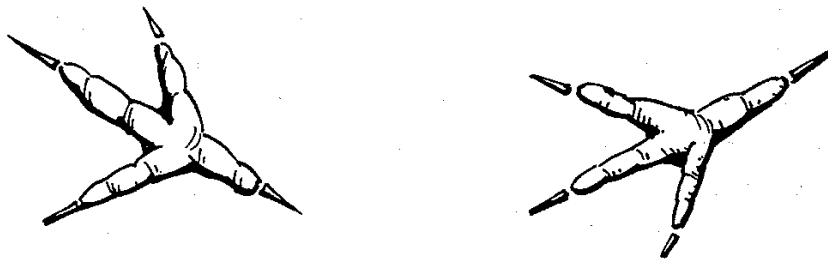

Tracks of a carrion eating bird indicated by the powerful front grasping toes.

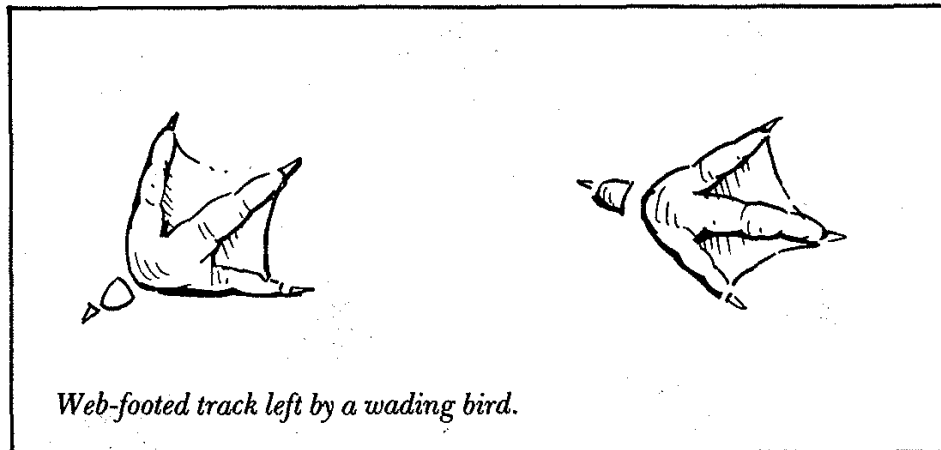

balance, importing the rabbit and the fox among other vermin to make tracking much easier.

BIRD TRACKS A bird that normally lives and feeds in the trees hops along the ground. Because of this the claw marks of both feet are placed (to the observer's eye that is) together.

The claw marks of a bird that walks and therefore is a groundfeeder — whether on carrion, seeds or grain — has a distinctly angular or walking gait.

In the marks of a bird that digs for its living there is, in addition to the walking gait, a strong impression of a strong hind claw, usually deeply indented.

In yet another set of claw marks on the ground, if the centre 'toe' is much longer than the others it indicates that the bird scratches to earn its living. Birds with this set of 'prints' are usually eaters of subsurface insects.

Talon-like claw marks indicate a carrion feeder, such as a crow, and a slight impression of a web in marks left in areas near water indicate that the bird probably is a swimmer. As with all marks a number of birds in any one of the above-mentioned species may deviate. Marsh birds such as the moorhen and the swamp hen, although they can swim, rarely do, and do not have webbed feet. Neither do the water-loving herons (the most common being the white-faced), let alone the vast number of smaller water and edge-of-the-water birds such as sandpipers and godwits.

MAMMAL TRACKS In the mammal world tracks are equally revealing in a general sense. Although it has been stated that mankind's success in dominating the planet is due to the opposable thumb which gave the hominid race a facility that no other animal ever possessed, certain of the ape family (the chimpanzee being about the best example) also have a rudimentary opposable thumb. Apart from man, in the world of mammals this generally means that they possess the ability to climb trees, although once again this is not necessarily so.



Tracks of burrowing mammals are indicated by the elongated and strong centre toes.



The typical pug marks of flesh-eating mammals. In Australia these are usually made by the wild dingo and the ferral cat.

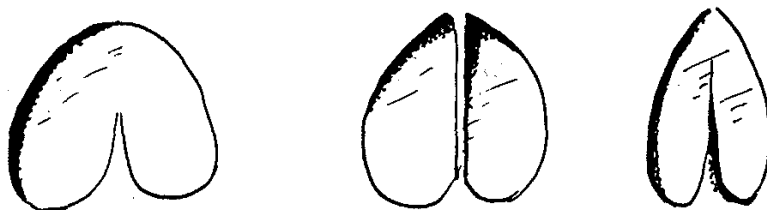

Tracks left by grazing animals such as cows, horses and sheep.

Where the claws of the centre toes are most prominent in mammal tracks this usually means that the animal in question is an earth digger or burrower. There is no sign of any form of a prehensile thumb.

Flesh-eating animals usually leave tracks that have pronounced toes. These heavy toemarks indicate that the animal uses its legs as a form of 'springboard' when running.

A completely different set of tracks is made by all grazing animals. Having neither climbing 'thumbs' to escape from enemies, nor digging tools to escape by burrowing, their only means of escape is by running.

In the Australian bush not all 'footprints' are studied on the ground. If you examine the side of a leaning gum tree — the slope that is often called the 'upward' side — you will see a number of scratch marks of varying ages. These scratches mean that the tree is a 'road' for possums and perhaps koalas. Possums either live in the dead hollows or come to the tree nightly to feed on the young leaves or mistletoe berries. By looking up at a tree you should be able to tell quickly if it is being used for feeding or for living quarters. If it is a tree that is being used for living, it will have many dead limbs, which will be hollow. These provide comfortable homes for many species of possums.

Dangerous snakes

There is no part of Australia that is snake free, although they are not normally found in large urban sprawls. Snakes have the ability, like some of our other wild creatures, to make themselves at home almost anywhere.

Although it is usually stated that snakes will get out of the way of any walker, there are times of the year when they will either stand their ground and attack or actually pursue a person. This is particularly true of the red-bellied black snake and the brown snakes during the spring mating season. A bushwalker should automatically avoid snakes if they are sighted. They should be left alone and not provoked.

Of the 150 or so snakes in this country 15 are regarded as

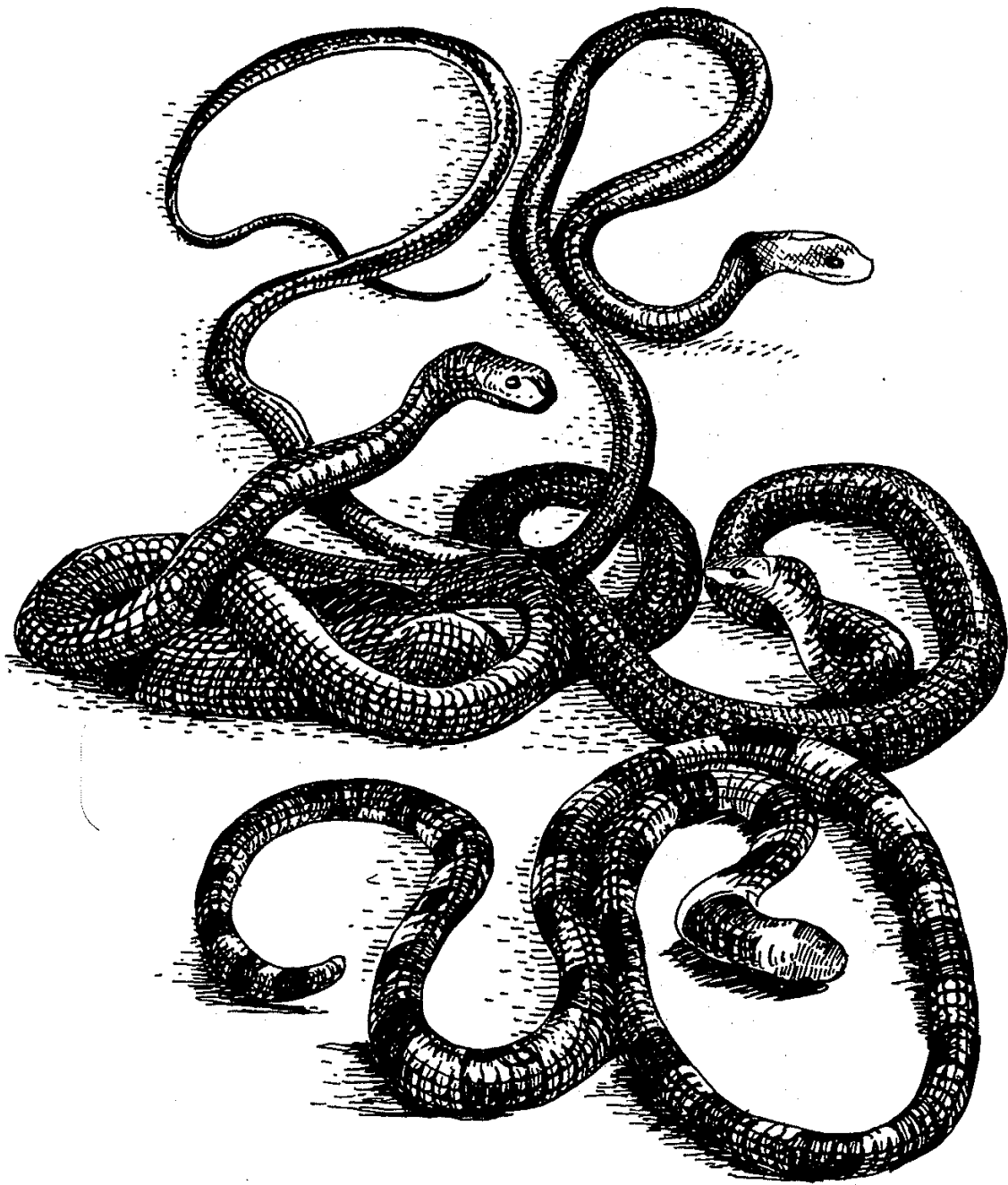

Most of the snakes in Australia are poisonous and some are extremely dangerous.

highly poisonous. The most dangerous of all our snakes is the small-scaled or fierce snake, once thought to be a subspecies of taipan. It was only reclassified as a completely new type in the 1970s. The small-scaled snake is an inland creature, its natural territory being the arid country where the borders of New South Wales, South Australia, Queensland and Northern Territory more or less join.

Others in this highly deadly group are the taipan (wet east coast of Queensland and the Northern Territory), the death adder (all States except Victoria), the brown snakes (all States except Tasmania), the king brown or mulga (all States except Victoria and Tasmania and excluding the wet east coast of New South Wales), the rough-scaled or Clarence River snake (New South Wales), the copperhead (found in Tasmania, Victoria and certain inland areas of New South Wales), and the red-bellied black snake (wetter areas of New South Wales and Queensland and Victoria).

Below this danger level there are other venomous snakes which can make a person sick but are not normally fatal. They are the black whip snake (Northern Australia), the broad-headed snake (Queensland rainforests) and the small-eyed snake (Queensland).

Our sub-tropical and tropical waters also harbour the beaked sea snake. This is an international rather than an Australian animal. Its venom is regarded as being as lethal as that of the taipan. However, sea snakes rarely attack anyone, being more curious than anything else. All sea snakes have a habit of inspecting skin divers at their leisure and from a few centimetres away. This can be unnerving. In general sea snakes are only really dangerous if caught in a net or a fish trap.

Although snakes are cold-blooded creatures, in Australia because of the warm summer nights many species, especially the black snakes, hunt in the evenings. Their prey consists of frogs, rats, mice and any other small creatures they can swallow. Particular care should therefore be taken if fishing an inland river, stream or lagoon at night as they will often be patrolling the edge as much as you are.

Other simple safety measures include not poking around in hollow logs with bare hands, taking care when shifting any bush log for your campsite and keeping the site clear of debris and large stacks of items. Snakes love woodheaps so keep yours small and airy.

As a general rule, unless sunning themselves in a secluded spot, snakes do not like open ground. They prefer to travel in cover. Therefore be cautious when crossing stretches of dry grassland.

FIRST AID FOR SNAKE AND SPIDER BITES The old bush method of treating a bite from a venomous snake or spider used to be to slash the wound with a razor blade, allow it to bleed freely, rub Condy's crystals into the slashed area and apply a tight tourniquet to the limb, between the bite and the heart. This method is now regarded as being more dangerous than helpful.

A tight tourniquet (which has to be eased every 30 minutes to prevent damage to the limb) is now only applied to the limb in the case of a bite by Australia's most venomous sea and land creatures. These are the Sydney funnel-web spider, the blue-ringed octopus and the box jellyfish.

In all other cases of bites a completely new approach is now used. Medical authorities have found that if firm pressure is applied immediately to the bitten area and the patient kept as still as possible the venom can be kept from moving through the bloodstream.

Once a person is bitten a tight bandage (preferably crepe) should be wound around the affected area. If no bandage is available any material will do — a shirt, singlet, T-shirt, even strips of denim from someone's trousers in an emergency. A large area of the bitten limb should be bound. Pressure should be about as tight as that used for supporting a sprain.

The limb should then be splinted using any strong stick, aluminium tent pole, or a combination of both. This splint should be bound over the bandage so that it holds it firm.

This dual pressure prevents most movement. The patient should be made to keep as still as possible. This bandage can

be left on until the patient reaches or is taken to a first aid station or hospital.

On no account should the bite be cut.

Spiders

Australia has two extremely dangerous spiders. The first is the red-back which is found all over the continent. The second, the Sydney funnel-web, is normally confined to roughly a 200 km radius around that centre — although there are signs that over about the past 10 years it has started to spread further westwards. Specimens (isolated only) are now being discovered in the central west of New South Wales.

The red-back spider will hide in almost anything, in a hollow log, a tin, under dry bark. Almost any nook and cranny can contain one. Campsite rubbish heaps are a favourite — another reason for disposing of waste material immediately. Country outhouse toilets seem to be one of their favourite hiding places.

Although the red-back is extremely small its venom is highly toxic. However, it acts slowly. The treatment is as for snakebite. But the patient should be immediately taken to the nearest hospital for an antivenene injection. Some experts advise not restricting the bitten area in any way, claiming it can increase the pain from the bite. Immediately after being bitten the victim will start to feel faint and drowsy.

If bitten by a funnel-web spider the victim starts to sweat heavily and soon becomes unconscious. This is one sort of bite that requires a tourniquet tight enough to stop the flow of blood. Release this tourniquet every 30 minutes or so to prevent damage to the limb and get the patient to hospital as quickly as possible.

If bitten by any spider, if possible either capture it yourself or get someone else to catch it. Hospital staff find this a great help in identifying it so the correct antivenene can be administered.

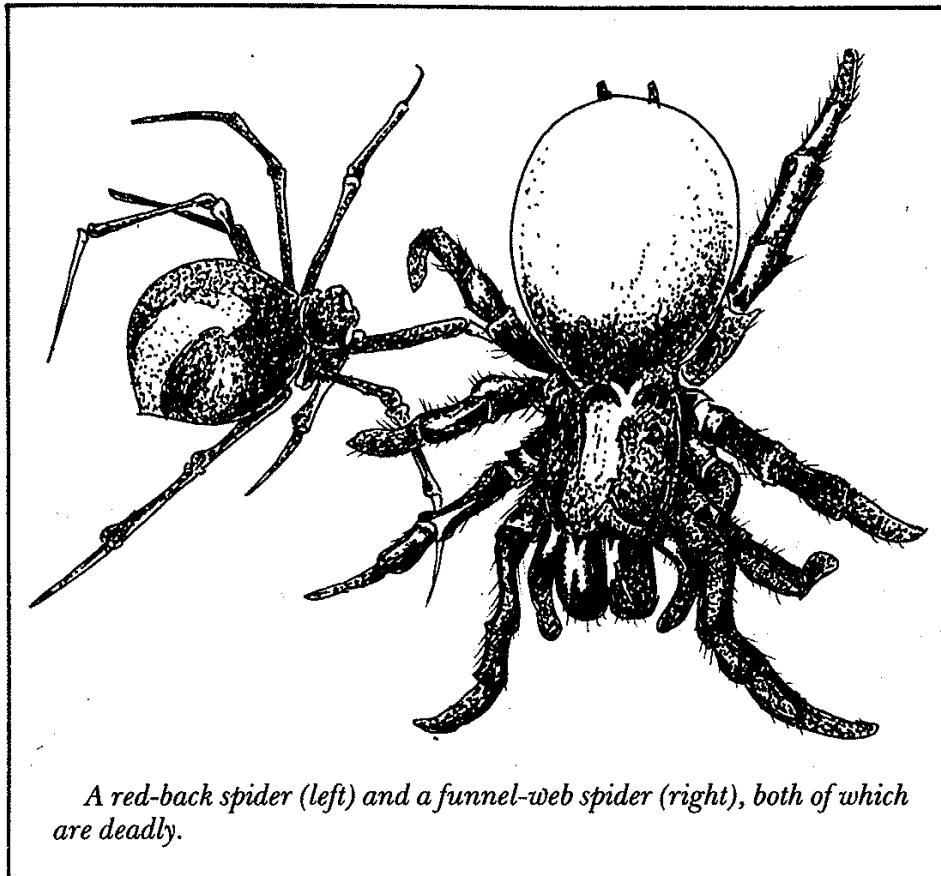

A red-back spider (left) and a funnel-web spider (right), both of which are deadly.

There are other spiders in the country that can inflict a painful and semi-venomous bite.

They include the wolf spiders and many other hunting spiders. Very little is known about the venom of most of the Australian arachnids but it can be reasonably assumed that quite a number of them are dangerous.

Because of this, avoid touching or coming into contact with spiders as much as possible. If one alights on your clothing brush it off rapidly. If you are in any doubt or feel at all unwell after you have been bitten, catch the spider and go to the nearest hospital. Some spider venom can take up to eight hours to affect a person so there is no need to panic.

Bush ticks

Bush ticks are found all down the relatively wet east coast of

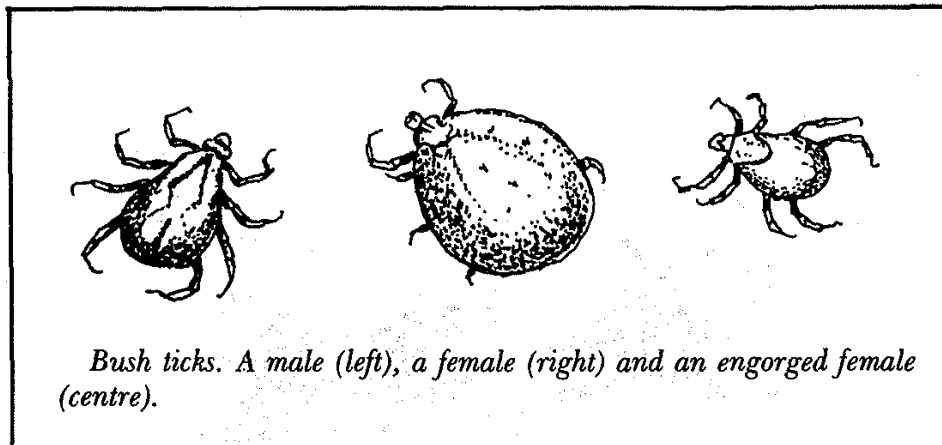

Bush ticks. A male (left), a female (right) and an engorged female (centre).

Australia from Queensland to Victoria. Although not usually lethal they can make a person very sick indeed.

Many of the nation's national parks, sanctuaries and walking trails are along this east coast belt, so a fair number of people get bitten by ticks. Some people have the belief that ticks are found only in rainforest regions. But this is not so. They occur in relatively open forest in many regions.

The tick drops from a branch, leaf or grass blade onto its host, burrows into the skin and proceeds to fatten itself by sucking blood. To ensure that the blood of the host does not coagulate during its feeding cycle — which usually lasts three to four days — it injects a poison that eventually causes paralysis.

Ticks have a habit of finding an out-of-the-way place on the human body to feed, so that they will not be brushed off before they properly establish themselves. Favourite places are in the scalp, behind an ear and low down on the back about belt line.

A person may not know he has a tick fastened to him or her. After walking in a rainforest area it is always advisable to organise a group search.

Ticks must not be pulled out of the body any old way. At the first pressure they grip hard. If pulled then the body will be torn from the head which will remain buried beneath the skin. The wound will quickly turn septic and the scar may remain for several months.

The best method is to touch the body of the tick with a hot match head, a lighted cigarette or dab it with kerosene or methylated spirits. This causes the tick to start backwards out of the flesh. At this point it should be pulled out with the fingers in a sharp movement or with a pair of tweezers. Remember it must be gripped below the 'shoulders' — where the head meets the body.

When they first alight on a person ticks are almost invisible but they quickly swell up with blood to about 1 cm wide and look like a little fat, black balloon on the skin's surface.

Although cats seem to have a built-in immunity to tick poison, dogs are very vulnerable.

Serious tick poisoning can be treated with a tick antivenene. If after visiting a known tick area you find difficulty in walking or co-ordinating your movements in any way visit your doctor. The tick will not be on you after a few days, having dropped off after feeding, but the poison will remain.

Bush leeches

Leeches are found in any rainforest area or where the bush is very wet underfoot. They can either be pulled off or removed by a dab of salt. Either way, because the anti-coagulant that they inject into the bloodstream while feed-

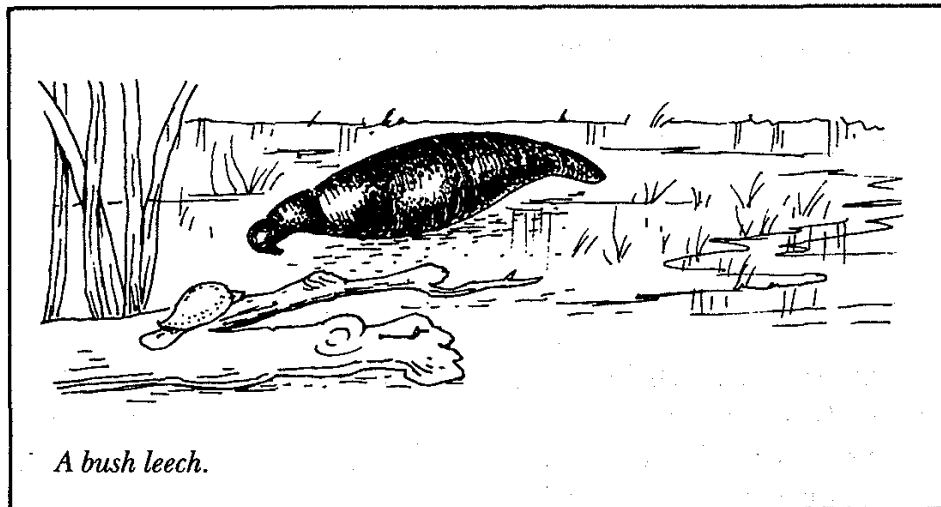

A bush leech.

ing, the wound will continue to bleed for a considerable time after they have been removed. Although they can land anywhere on the body, the ankles and inside boots are favourite targets. Most leeches can creep through the eyeholes of lace-up walking boots. Soap in the eyelets is said to deter them. There are also several commercial insect repellents which, if sprayed on the boots and the ankles before walking, will do the trick.

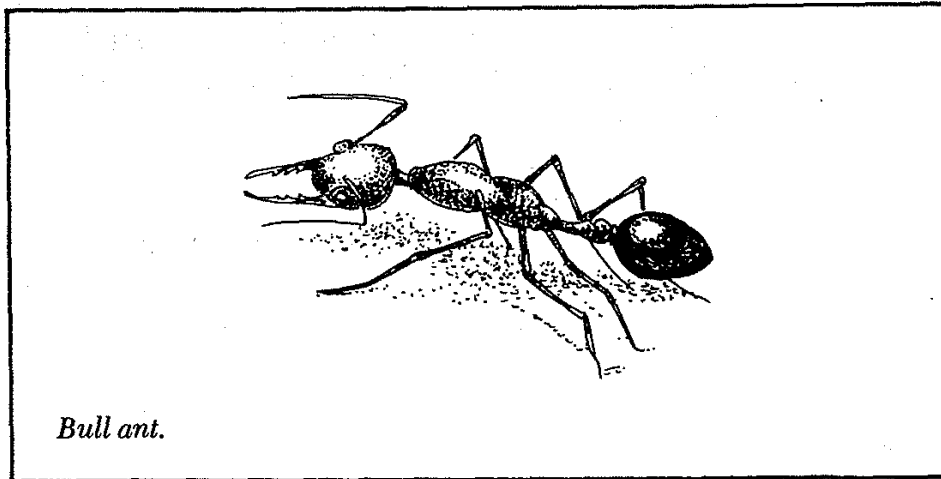

Ants

Australia holds the record in yet another dubious category of having possibly the world's most dangerous ant. It is the black bulldog ant (*Myrmecia forficata*) of the coastal regions.

Two fatalities have been officially recorded from the sting of this ant, one in the Mt Macedon area of Victoria in the 1930s and another in Tasmania in 1963. Both victims died within 15 minutes of being bitten.

All of the larger species, known generally as bull ants, especially one known as Jumping Jack — which will actually defend its pathway by leaping at an opponent, no matter how large, should be treated with caution.

The stings, in the tail, are exceedingly painful but they generally wear off after a time. However, some people are allergic to ant stings (as others are to bee and wasp stings). If the swelling continues to increase and the whole limb starts

to puff up after several hours (instead of subsiding) medical treatment should be sought.

In normal circumstances a cloth saturated with cold water will relieve both the pain and the swelling. Calamine lotion also helps.

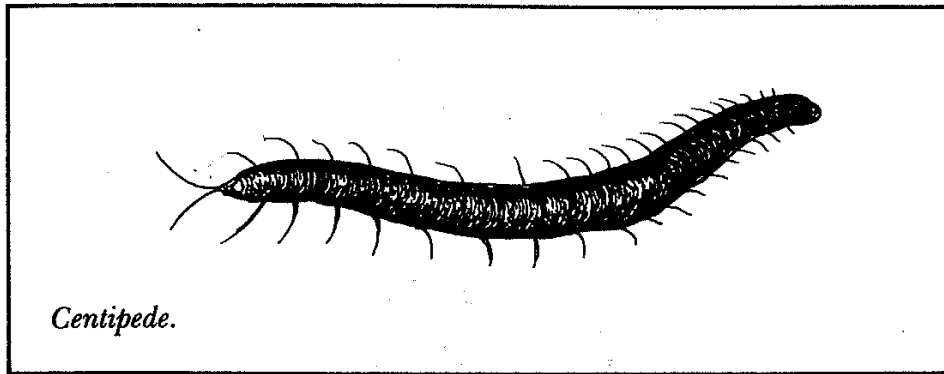

Centipedes

Although most people can't stand the sight of them, centipedes are relatively harmless in the Australian bush. They can and do bite and are slightly venomous. Very few people suffer any after-effects.

Centipedes seek warmth at night and can often be found nestling either in or under sleeping bags.

Sea creatures

As mentioned, both the box jellyfish (sea wasp) and the blue ringed octopus are highly dangerous. The box jellyfish, which is found in all tropical and sub-tropical waters during the summer months, can kill a person in about 30 minutes if the bites have been severe.

The best advice here is to *avoid*. Don't go swimming in tropical or sub-tropical waters during the summer months. The surf may be inviting but it could also be fatal.

If someone is stung by a box jellyfish, drag him or her from the water as quickly as possible. Avoid touching the entangling tentacles yourself otherwise you will be stung as well. And this is where alcohol, normally shunned in any

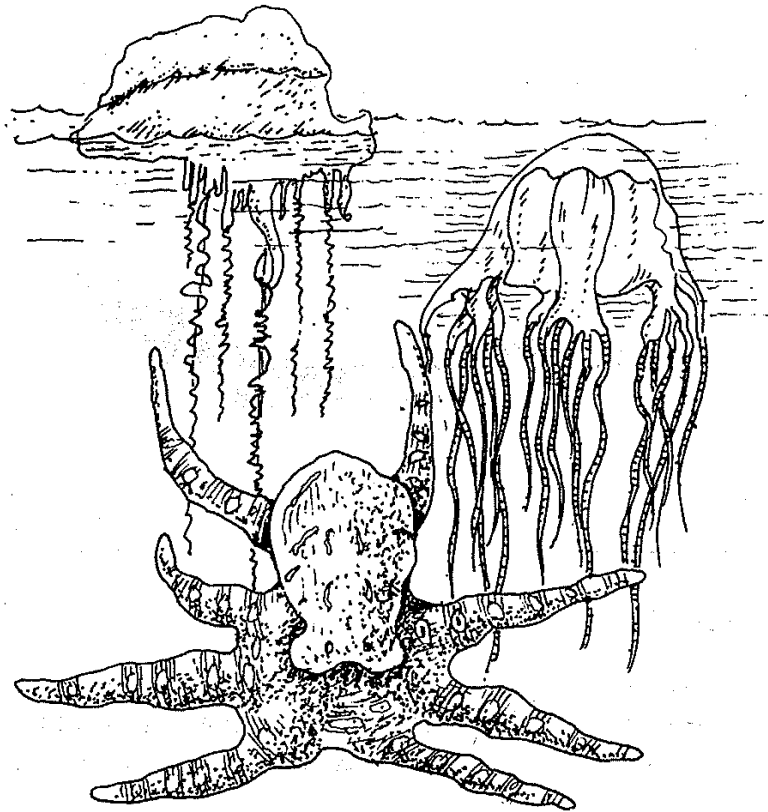

Dangerous sea creatures: bluebottle (top left), box jelly fish (top right), blue ringed octopus (bottom).

medical treatment for anything, comes into its own. Flood the tentacles and the sting marks with methylated spirits if possible. This will kill the living darts still in the tentacles and prevent further stinging. If you don't have methylated spirits, any spirit will do — whisky, rum, gin or vodka. It is not as high in alcohol content as methylated spirits so more of it will have to be used to kill the stinging barbs.

If the victim stops breathing apply mouth to mouth resuscitation immediately. It is a good idea to take a course in this most valuable skill if you are planning a lot of camping. Voluntary organisations in most States will willingly give instructions.

The victim should then be taken to the nearest hospital as quickly as possible to receive an injection of antivenene.

The treatment is essentially the same for the bite of the blue-ringed octopus.

Another common sea creature off Australian beaches during the summer months is the bluebottle. They get washed up on surf beaches in their thousands. They are relatively easy to spot as they float in colonies in or just beyond the surf line.

If you see them, stay out of the water. However if you are bitten douse the stinging welt with methylated spirits and then apply vinegar. This usually eases the pain.

Vinegar can also be used to ease the bites of the almost invisible sea louse that also turns up in the surf, usually in the early summer months. This bite is irritating but no more than that. However, some people are more allergic to the bites than others. The bites appear as large round red welts on the skin, more or less like huge flea bites. If necessary, treatment can be sought from a hospital. But as stated these bites are uncomfortable but not highly dangerous.

Poisoning

Although there is less danger of being poisoned by the products of mankind in the bush, accidents sometimes occur. In some cases the poison can be diluted in the stomach by milk, in other cases vomiting can be induced by a commercial syrup (available from any chemist) known as Ipecac. It is wise to pack a bottle of this in any first-aid kit.

Two of the most dangerous poisons are those that are alkaline and those that are acid. In both cases the patient should *not* be made to vomit. Large amounts of milk, which soothes gastric irritations and dilutes the acid or alkali, should be given. Failing the availability of milk, if possible the patient should be made to drink large quantities of water. In both cases hospital treatment should be sought as soon as possible.

In the case of food poisoning (ptomaine) one of the most

common problems is that the patient is unable to vomit. In those cases Ipecac syrup should be given.

If the poison is on the skin, wash very well with soap and water; if in the eyes, the eyelids should be held open and the eyes bathed with warm water.

If the poison is inhaled the victim should be taken or dragged into the fresh air. If the patient is overcome and there is a pulse but no breathing begin mouth-to-mouth resuscitation immediately. Loosen all clothing.



First-aid kits

A first-aid kit can be large or small. It depends on the needs of the party and their ability to carry the extra gear. In car camping, of course, weight is not a problem and a comprehensive kit should always be carried.

It should include dressings, gauze and crepe bandages, adhesive dressings, cotton wool, scissors and needles (for removing splinters). A bottle of iodine, although somewhat old-fashioned, is good for preventing wounds from festering and there should also be a tube of antiseptic cream. As mentioned earlier a bottle of Ipecac syrup is also handy, plus a small bottle of methylated spirits.

After that it is up to the individual to include such things as aspirin, sunburn cream, calamine lotion (for insect bites and stings) and any personal medication that is used on a regular basis. For instance if one suffers from eye strain or eye irritation, eye drops are handy, otherwise warm water is as good as anything.

There is no need to buy a commercially manufactured kit, complete with a red cross on the tin. Your chemist will make one up for you at half the cost and any watertight container will do.

8 Travel and weather

Although most walkers travel on known tracks, rough maps of which are often provided by parks and wildlife authorities, there are times when one faces more or less unknown country. The central mapping authorities of the various States all provide detailed maps of various sections of the country.

A map of your intended or favourite walking area should always be obtained and kept in your pack at all times. Natural and man made disasters can often alter the face of any given stretch of land. In this case a map will help you recognise the salient features and get your bearings.

The right gear is also essential for the enjoyment of any bush holiday. And although a bewildering variety of camping essentials and aids is now available some can be improvised on the spot.

The serious bushwalker is advised to take a course in map reading either through instruction from a recognised club or, more informally, with the help of experienced friends.

Plotting a course

Before you set out on a journey through the bush get hold of a map of the area. The best maps are those prepared by the State mapping authorities.

Any map is a plan of a section of country. Being a plan it is drawn to a scale or proportion and this is nearly always shown prominently at the foot of the map. It should also show both true and magnetic north. Government maps always show both and indicate the degree of error. Thus the

good map will show grid north, true north and magnetic north. Underneath it will also carry the legend, 'True north, grid north and magnetic north are shown diagrammatically for the centre of the map. Magnetic north is correct for 1975 and moves easterly by 0.1° in approximately three years.'

This is important when you are attempting to get an accurate reckoning. Commercial maps printed by private firms do not often contain this information.

The official maps also give average rainfall and temperature patterns for all months of the year, which is extremely useful in planning a trip. Added to that they will give specific dates as to the total accuracy of the chart, thus 'Aerial photography 1971, field revision 1977, printing 1981.' This enables you to record changes (most of the changes being man-made) and also to make allowances for any such changes in planning your route.

If true and magnetic north is not shown on the map remember to add both before setting out. Show true north as a strong line and magnetic north as a dotted one.

Then study and learn all the other symbols used in the map; built-up (settled urban) areas, the various types of roads and their surfaces — remember that these can change — and railways, power lines and the like. A good map will also indicate the ground cover as well as the land contours, indicating where there is either dense cover or medium timber, low scrub and so on. It will also show State forests, recreation areas, shire and parish catchment areas, mine subsidence areas and even such man-made plantings as orchards and windbreaks.

Although once again some of these features are subject to change, especially if the last survey was some years back, they still will give you valuable clues as to your whereabouts if you take care to read them properly.

Sometimes you will be making a journey that will cross from one map area to another. Take both maps. This sounds like very obvious advice but it is remarkable how many people assume that the lie of the land is not going to alter from one grid area to another and decide to get by by

guesswork or by 'asking along the way.' Stranger things have happened.

Logging a route and making a chart

A log is a record of the essential information about your journey. Although it is unnecessary for short walks along well-defined trails, on longer journeys it forces you to study the country keenly and recognise it.

When making your first log do not, as a general rule, use growing features to mark changes in your route. This is quite a general error and perhaps comes from childhood maps of mythical buried treasure. Remember that the 'large dead tree' or 'wattle grove' may be destroyed by a bushfire in years to come. You may remember your way through the area again, due to familiarity with the general topography, but it would be worse than useless to a person who had no knowledge of it.

It is somewhat regrettable that a number of bushwalking clubs still use this method. It is the same with government maps, of course. It once used to be quite a common practice

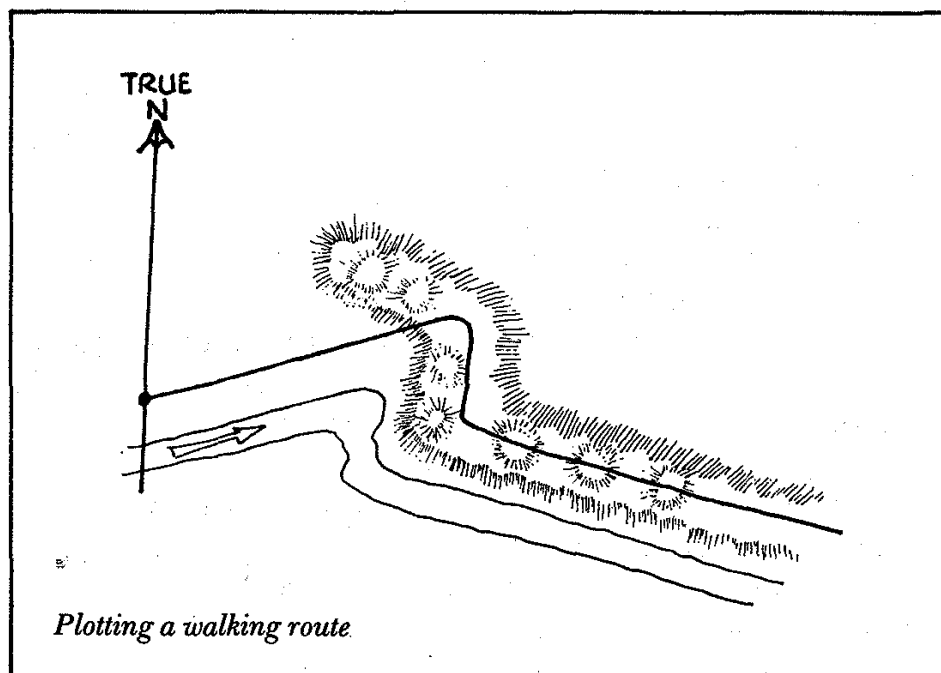

to get a bearing on a church (one that had a steeple). However, in country areas these days churches are disappearing at an alarming rate. They are being replaced by other man-made objects such as radio towers and high voltage electricity grid lines. By and large, attempt to stick to landforms with some permanence.

In making your log it helps to work out the time needed for the journey. Before starting out study the map and work out the different types of country to be covered. You will be able to plan, in a general sense, how long you will need under favourable weather conditions.

The rate of travel varies. On open undulating country with short grass underfoot a walker will manage 1 km in about 15 minutes or slightly less. But in steep rocky country with scrub and thick growth it might take three-quarters of an hour. In heavy entangled rainforest areas with swamps, ravines and other obstacles it might take half a day to travel 2 km.

The following guide may be considered to be a fair guide to walking paces. Remember there is a tendency to overestimate the rate of travel.

Country	Time to walk 1 km	
	min	max
Open country, firm underfoot, level or slightly undulating	15	20
Scrubby country, rocky underfoot, ascents up to 30 metres, similar descents	20	30
Scrub and jungle, steep ascents and descents to a 1-3 grade, bad underfoot	30	40
Long, steep ascents and descents of up to 300 metres, rocky and uneven underfoot	50	90

The figures in the table are for an active, fit person carrying a pack of 15-20 kg. With heavier loads the maximum time should be taken as a more correct guide.

On level ground the rate of progress can be checked by the walker. A man with a long stride will take 110 paces for every 100 metres at a rough count on level ground. Thus a person can time him or herself over a kilometre. Over broken or rocky ground paces taken are much shorter — perhaps 200 for 100 metres.

A log is kept most easily by recording the information in vertical columns, as shown in this example.

Time	Rate of travel (km per hour)	Distance (km)	Bearing
8.30	3.5	3	84°
9.30	2	1	197°
10.00	2.5	3.75	110°

Observations

- Stage 1: Open grassland, moderate walking. High ranges to east about 5 km. River about 2 km south.
- Stage 2: Climbed steep saddle to range crest. Rough and stony. Grade on top 1-8. River 500 metres south at foot of ranges.
- Stage 3: Crest of range stony underfoot. Many smaller crests to be climbed. Sides too steep to detour. River going south-east along foot of range. Range itself rising to the east.

This information can later be plotted, thus providing a chart of your route. With this chart plotted on your map, you should not get lost because you should know where you are in relation to the point from which you started.

Choice of route

Given a free choice it is always advisable in cross-country travel to choose a route up spurs and ranges and down streams unless you are in very mountainous country. By following this principle there is less likelihood of getting lost. This is because all spurs lead to the crest of a main range and all streams eventually lead to a main river course. By travelling down spurs or up rivers it is very easy to take a wrong spur or follow the wrong watercourse and thus in a short distance find one's self hopelessly bushed.

This applies to country that is sparsely populated. Therefore before setting out across country it is advisable to carefully study the map and plan your route, remembering all the time the general rule: up spurs and down rivers.

The sketch map will show you how easy it is to get bushed by travelling the wrong way. The wise bushman wishing to go from A to B will choose route C rather than route D.

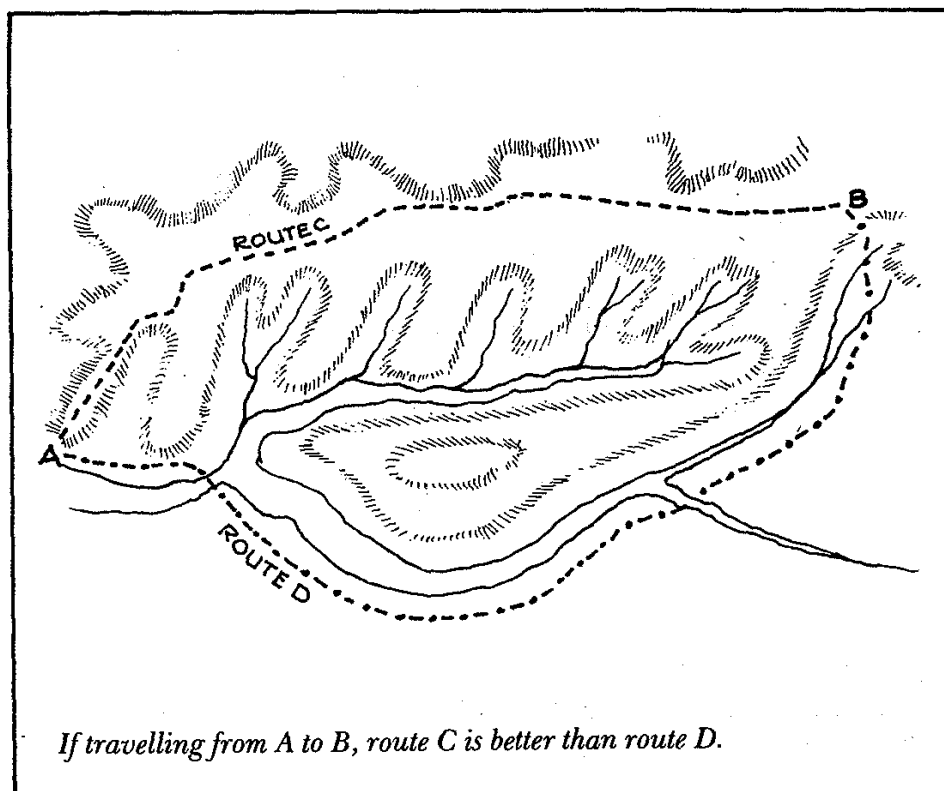

Map reading

As stated earlier, when interpreting any map do not place too much faith on man-made structures. The basic surface of the land is unlikely to change in your lifetime but man's works vanish.

The most obvious natural features are ranges and rivers. The ranges may be steep or sloping. Their gradients are shown by contour lines or hatching.

Contour lines are imaginary lines parallel in height and with equal height separating one line from the next. By correctly reading these lines you can tell whether a hill is concave or convex in its slope.

Not all contour lines carry a height indicator. Sometimes they are marked in 'steps' of 100 metres, but if slopes are very steep more indicators are given. The crest of a ridge or a prominent landform is usually given its exact height.

Position on a map is always given by map reference num-

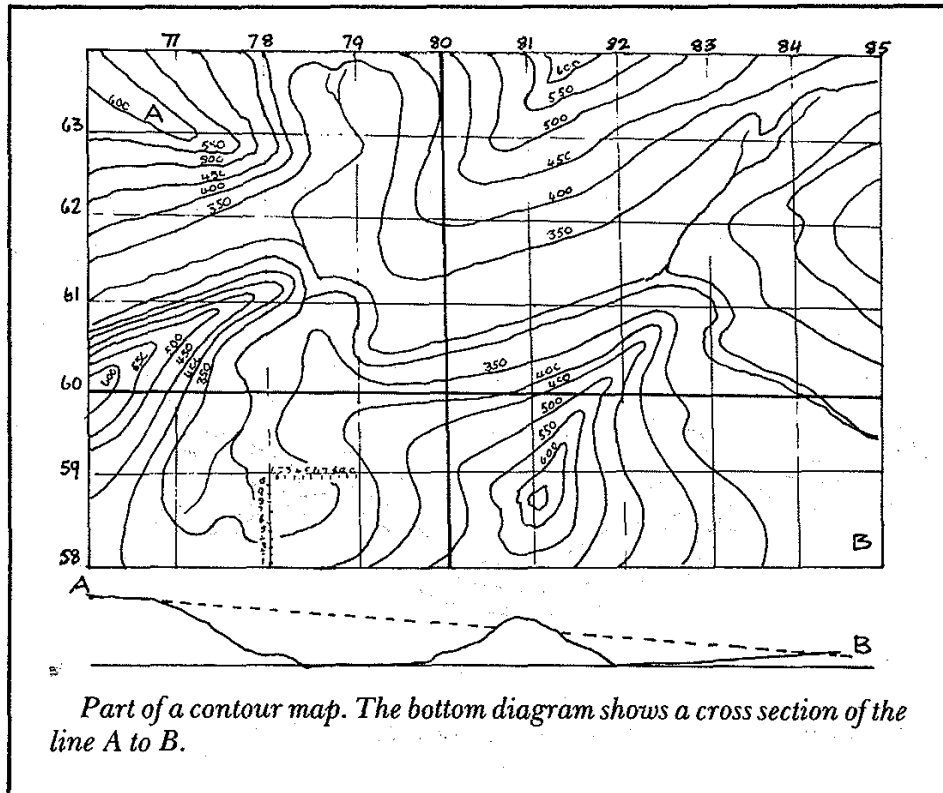

bers. These are the series of numbers which indicate the square referred to. The numbers read vertically and horizontally. These map references are read from west to east first and then from south to north, so that the figures 78.58 for example mean that you look along the grid line 78 until it matches the other grid line 58. The object is within that square.

Sun compass — sun clock

Direction and time can both be obtained by drawing a sun compass — sun clock on your map. Trace off the illustration on page 276 for the latitude line nearest to your map and it will be both a compass and a clock.

With a sun compass — sun clock, when you have any one of the following you can find the information the other two would provide.

1. a watch to get the correct time
2. a reliable compass
3. a map correctly oriented (that is, laid on the ground so that the features drawn on the map correspond exactly with the recognisable ground features).

WHEN YOU ARE ABLE TO ORIENT YOUR MAP CORRECTLY The north-south line of your sun compass will correspond with the north-south line of your map. Your time is read by placing a shadow stick in the middle of the sun compass. The figures around the outside of the centre circle are read as minutes (the heavy lines are hours). They are added or subtracted from the reading of the shadow.

To orient your map select two or, better, three recognisable land features and identify these. Turn your map until the identified features correspond exactly in direction with the ground features. When this is done the map should match up with the ground plan visible from your position.

WHEN YOU HAVE A WATCH SET TO CORRECT TIME Place a thin shadow stick on the centre line of the sun compass which

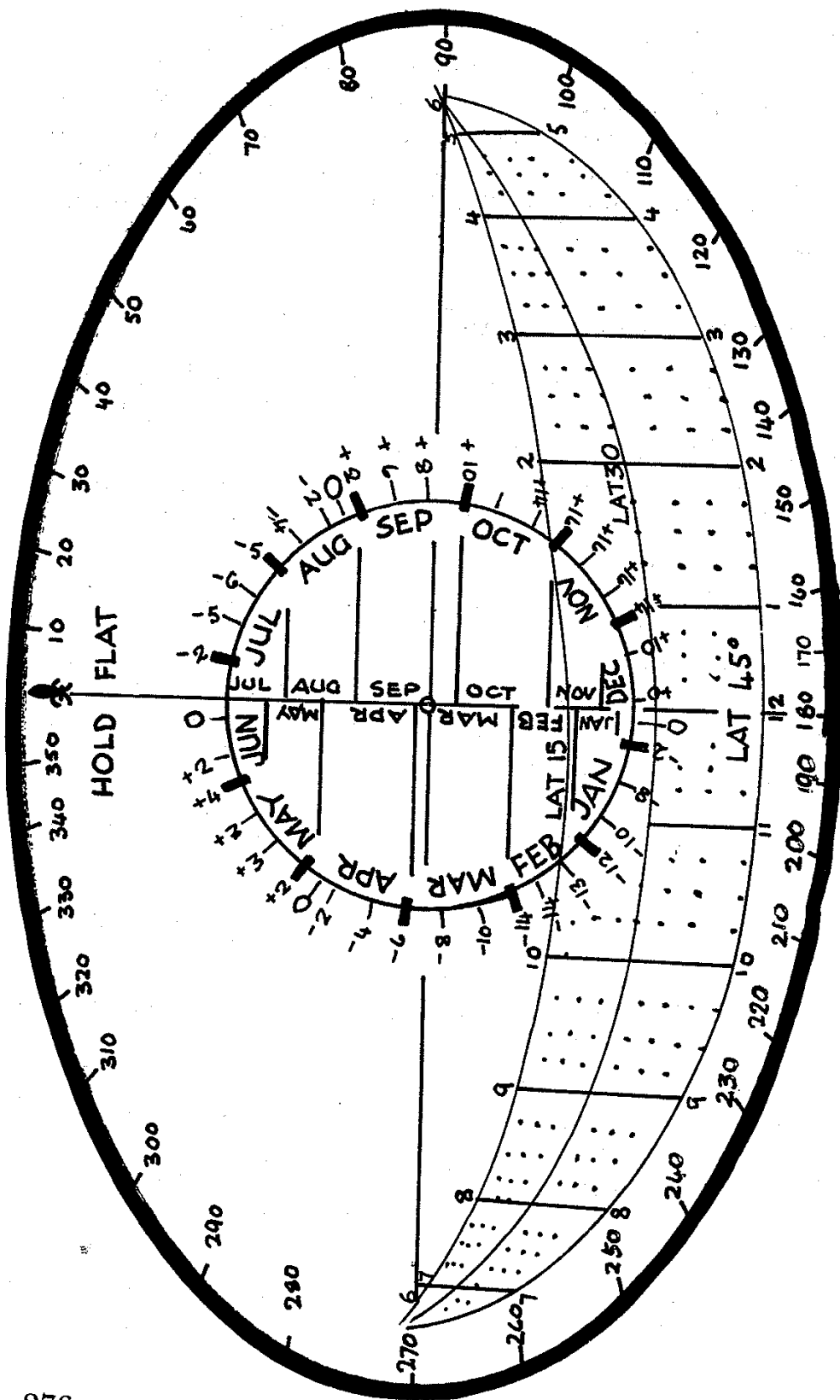

The sun compass and clock.

must be held flat opposite the appropriate date and turn the map until the shadow falls across the adjusted time on the latitude line.

When you have done this your map will be set to true north and oriented with the ground features.

WHEN YOU HAVE A COMPASS Place the compass on the map with its axis along the line of true north and turn both the map and the compass until the compass needle is pointing to the magnetic north of the map. This may be east or west of true north depending on where you are. To do this of course you must have a government-produced map.

When you have done this hold the shadow stick on the north-south line of the sun clock opposite the appropriate date. Where the shadow of the stick falls across the latitude line is local sun time.

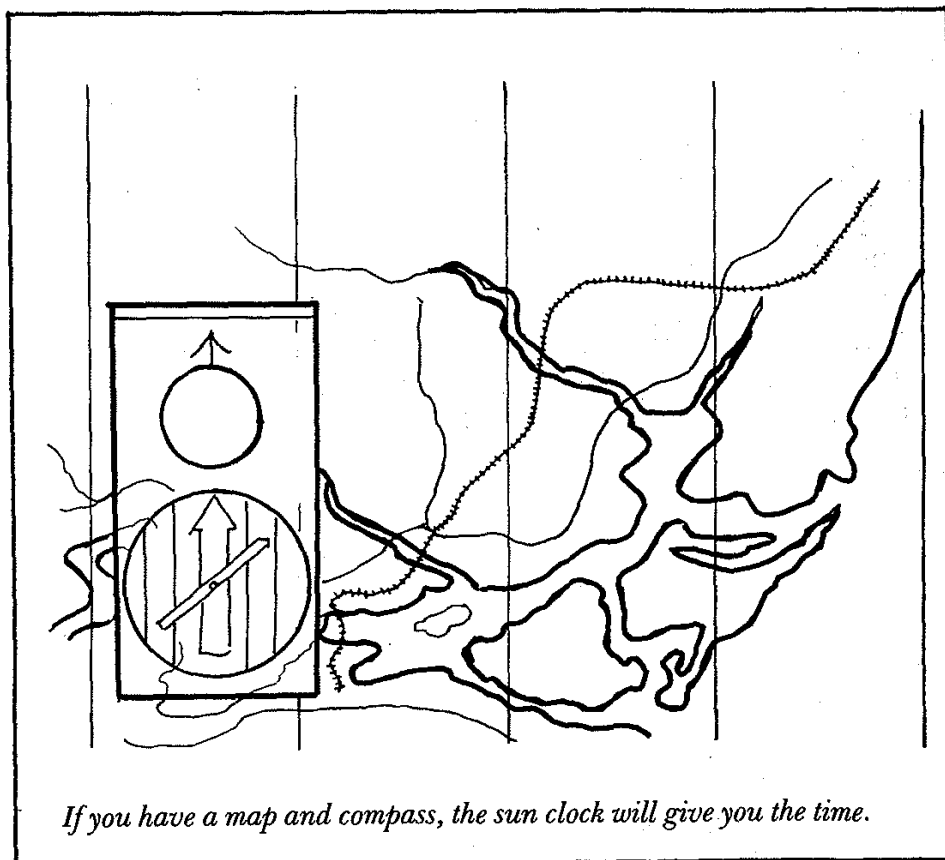

To correct standard or clock time (daylight saving in most States in summer) make the correction for the equation of time shown opposite the date, plus the correction for longitude, by deducting four minutes for each degree you are east of the longitude of standard time or by adding four minutes for each degree you are west. (When east of the longitude of standard time the sun is earlier, and when west the sun is later).

When the magnetic north of your compass needle corresponds with the magnetic north of your map then your map is correctly oriented.

Weather signals

There are almost as many human ways of predicting the weather as there are people. Almost everyone has a weather saying that they secretly believe in.

These range from the old 'Red sky at sunset, fair dawning. Red sky at dawning, shepherd's warning,' to the couplet:

When the rain is before the wind, your topsail halyards
better mind,

But when the wind is before the rain, then hoist your top-
sails up again.

What this says in essence is that when rain comes first without wind then one can expect a long period of bad weather with high winds and heavy rain. But when the wind comes first and is followed immediately by rain then fine weather will follow shortly afterwards. Like all sayings, sometimes it is true and sometimes it isn't. Australia, after all, is not the Atlantic ocean. But intelligent sky watching can give the walker some indication of a possible weather change.

For that, cloud identification is helpful.

Clouds

CIRRUS High altitude clouds which rise up to 14 000 metres in temperate regions are made up of ice crystals. They are usually thin and white. Because of their shape they are often called 'mare's tails'. They are normally associated

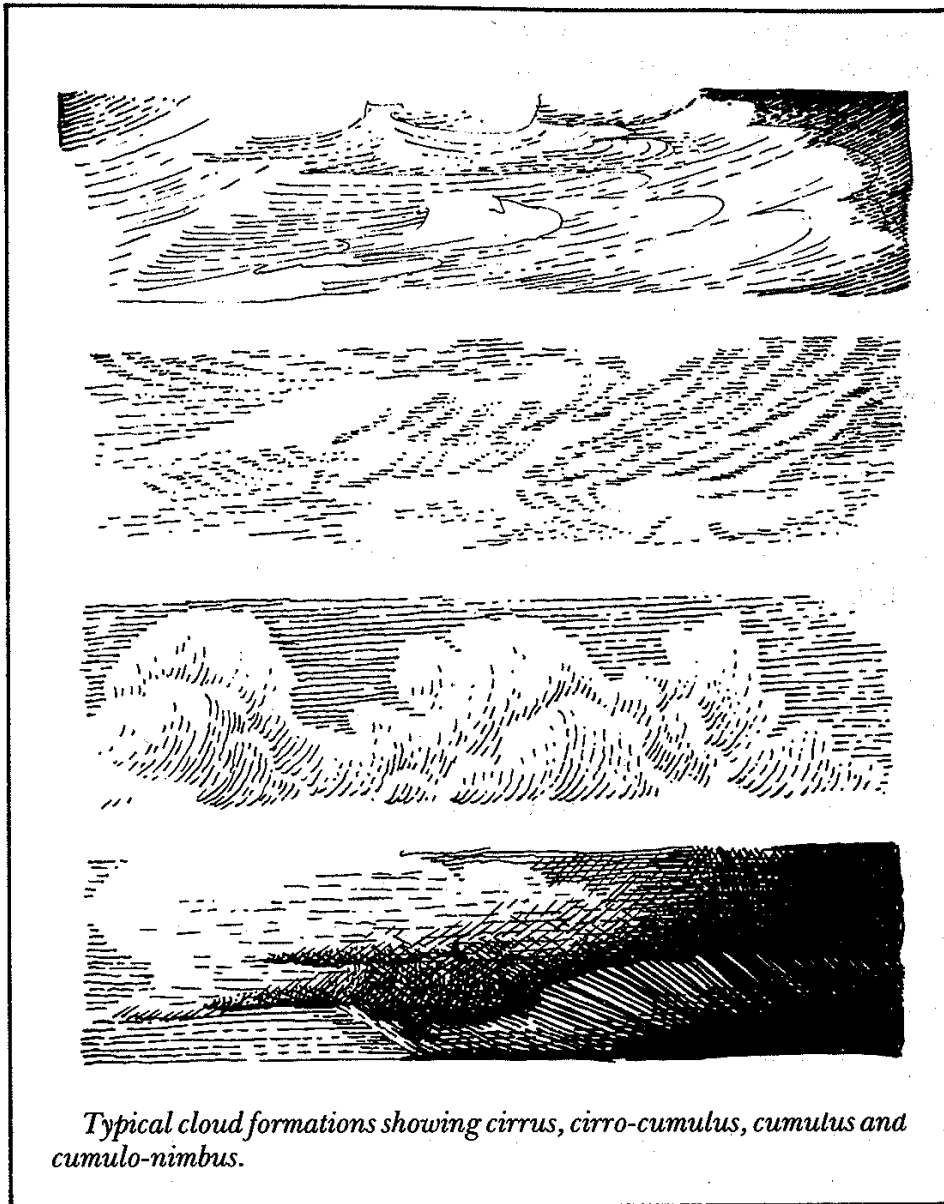

Typical cloud formations showing cirrus, cirro-cumulus, cumulus and cumulo-nimbus.

with high barometric pressure, which indicates continued fine weather.

CIRRO-STRATUS Another type of high altitude cloud, rising to 20 000 metres, they often form a white, semi-transparent veil across the sky, not, however, completely hiding the sun or moon. Again they are associated with a high pressure system which usually indicates fine weather.

CIRRO-CUMULUS These clouds, which can hover anywhere between 5 000 and 14 000 metres, are globe shaped and form wave patterns, and give rise to the name a 'mackerel sky'. Once again they indicate a general high pressure system which means clear, fine days.

ALTO-STRATUS A middle-range cloud formation which hovers around 7 000 metres. The clouds are composed of a thick layer of water droplets which at times can cover the sky and obscure the sun. On the coast they can bring rain but in inland areas, especially in the winter, they are uncertain, sometimes meaning only a cold, dank day.

ALTO-CUMULUS Occur in puffy ball-like bands in the sky. A middle level cloud which could mean a change in the weather.

STRATO-CUMULUS A dense grey cloud with darker shadings in patches, sheets or layers. Generally it is a fine weather cloud but it can bring some light drizzle.

CUMULUS A large puffy cloud mass often 100 metres or more deep. Cumulus clouds billow and change shape constantly. These clouds are formed when warm, moist air rises over a heated land or sea mass. They often bring rain, usually sharp and fierce thunderstorms.

STRATUS A low, grey, uniform cloud with the appearance almost of a high fog. The whole sky takes on a leaden look. Invariably stratus, unless driven by high winds, brings light rain or a misty drizzle.

NIMBO-STRATUS The base of this cloud is generally around 2 000 metres. A dark blue-grey mass, it brings rain, sleet and snow which may last for several hours.

CUMULO-NIMBUS This massive black-grey cloud mass with its distinctive anvil-like top is the classic thunderstorm warning.

Although because of its intense violence it often rises to 20 000 metres it is classified as a low-level cloud (its base often seems to be hugging the treetops). Violent updraughts within this turbulent system often form huge chunks of ice at the higher levels, producing severe hailstorms as well as drenching rain. Lightning and gale-force winds often accompany the cloud mass. The storms are often extremely destructive, doing great damage to the bush and to buildings.

Weather patterns

Although weather patterns can vary wildly in various parts of Australia from year to year — the years of drought and the years of flood, for instance — different parts of the continent do have similar patterns each year to some degree. Weather bureau experts, of course, caution against placing too much reliance on any fixed pattern, stating quite rightly that scientific records of the country have been kept for a very brief period in time. However each State has peculiarities all its own and it is perhaps wise to take note of these generalities before planning a trip in any given season.

QUEENSLAND The rainy season starts in late November or early December and usually ends in April, although it can extend to the end of that month. The rains then fall off until the true dry season is reached in August. This usually extends through to November, although some heavy thunderstorm activity is often experienced in October.

The northern cyclone season runs from November through to April, the duration of the wet season, although January and February are regarded as the most dangerous months. On average about three cyclones strike the Queensland coast each season causing varying amounts of damage and flooding.

NEW SOUTH WALES Despite popular belief the coastal areas of the State can have very wet summers — about once every

four years. January and February are the target months for these summer rains, which can cause severe flooding in coastal regions.

Normally the State starts to dry off in April, but in wet years rains can continue through to the end of June.

Severe storms can occur in July and this is often the time when the Southern Alps receive their heaviest snowfalls. September and October can also be wet months on the coast although in the inland areas apart from reasonable spring rains in a 'good' season, the weather is normally dry.

High pressure systems usually lead to long dry spells in October and November but December is almost a freakish month in which almost anything can happen.

SOUTH AUSTRALIA This State's dry season runs from November until March and very little rain is received during this period.

From March onwards rainfall usually increases, with June normally receiving the highest rainfall especially along the State's south coastal region. This wet continues into July after which it starts to tail off until the start of the dry season the following November.

VICTORIA December is one of this State's wettest months on average and it can also be extremely cold (for summer) as well. January and February on the other hand are rather dry with the rainfall increasing at the start of Autumn in March, when the temperature starts to drop. Quite often in late March and early April Victoria can get an 'Indian summer', some of the best times for camping with warm days and cool nights. June and July and then October are generally cold and wet.

TASMANIA Tasmania's 'wet' season usually starts about mid-March and extends through until the end of June with flooding possible in any of these months. On the east coast

the country starts to dry out a little in both June and July, but the west coast generally remains cold and sodden. After that the pattern becomes variable, with warmer weather in the spring months, but with plenty of rain by mainland standards.

The weather starts to dry out somewhat in December with January and February usually the driest months.

WESTERN AUSTRALIA Western Australia is a difficult State to describe in terms of weather because it covers a broad range from cool temperate, through arid, to subtropical.

The cyclone season in the north is the same as that for Queensland — November through to April — the wet season in the north. Once again the greatest danger period occurs between January and February. The Western Australian average for cyclones reaching the coast is slightly lower than that of Queensland — about two per season.

In the north rainfall, cyclones or no cyclones, can be very high, with a risk of flooding in February and March.

On the whole most of the State has dry winters, including the southern areas. Summers are very hot and dry. Spring in the south is usually fairly dry but with a smattering of showers.

NORTHERN TERRITORY As with Queensland and Western Australia, the cyclone season in the 'top end' starts in November and runs through to April. Cyclones in this region can be extremely severe.

The weather starts to dry off in the autumn, which is regarded as the best time for touring the Centre, although occasional freak winter rains have been known to flood even Alice Springs during the winter and spring. On average these occur about every seven to ten years.

The dry in Darwin and its surrounds extends from the end of the cyclone season in April until the start of it again the following November. December can often be the wettest month.

Survival

Although in theory the careful bushwalker never gets lost, accidents will happen. Every year there are innumerable reports of both experienced and inexperienced parties getting bushed, sometimes through no fault of their own and sometimes, it must be admitted, through carelessness.

Because of this, walking clubs all over the world have devised various survival packs of basic items which should always be carried whether or not the walker is on a designated trail, simply out for a half-day ramble to look at spring wildflowers or embarking on a more serious venture.

These survival packs are not Australian in origin. They are worldwide. At one extreme they can be so cumbersome that no one in his or her right mind is going to carry the things.

A well-known American bushwalker, Bill Riviere, in his book *Backcountry Camping* pithily took apart one of these monster outfits that had been composed by a committee of scientific survival experts.

His analysis is worth quoting here (plus his comments) as an example of how the desire to survive can perhaps turn into severe paranoia.

'Elaborate survival kits are incessantly suggested, including water purification pills, plastic water bag, plastic sheet for shelter, surgical tubing (for a slingshot!), candle, nails (I suppose with which to build a cabin if you must spend the winter!), flexible wire for snares, hooks and a fishline, dehydrated foods, steel wool for tinder, a flexible wire saw, first-aid kit, flashlight, mirror, plastic tape (with which to bind the splint on a broken leg, I presume), police whistle, safety pins, sewing kit, aluminium foil, rope, razor blades, flint bar and a hone.'

As this is all in addition to the standard and almost universal world-wide survival kit of compass, map, short axe, bush knife and matches in a waterproof container, Riviere was quite justified in concluding, 'With such a kit, it's not a question of survival. The problem is carrying it!'

Most basic survival kits are based on the map-compass-axe-knife-matches theme. In Australia the axe is quite often omitted and normally some water container, such as a water bottle or billy, with water purification tablets, is included. Some people simply pack a firmly lidded billy with matches, lighter, tablets, a waterproof vial of salt and some bright red plastic electrical marking tape (for marking a path taken). A water container is important in this country as water does not lie all over the place. Other items can be added within reason.

Some walkers either buy or devise belt pouches which hold the essentials securely. This means they can always be on one's person and will add very little additional weight and cause little inconvenience.

Experienced bushwalkers also warn about placing too much reliance on the compass and map when lost, pointing out that some compass needles can mislead and the maps may be out of date. In heavy bush country where there is almost no visibility a compass can be almost useless.

Generally speaking, a party on say a six-day hike and carrying quite a lot of food because of this has a much more comfortable time of it if the members do get bushed than the day walker who was not expecting to be out overnight.

It is also a curious fact that despite the health risks associated with smoking, smokers invariably carry a plentiful supply of matches, or a cigarette lighter. It is always the non-smoker who suddenly realises too late he hasn't any means of making a fire.

If one does become lost the standard advice is as follows.

- Do not panic.
- Sit down and assess the situation. Check what water and food supplies you have, if any.
- Make some attempt to retrace your path. It is always better to attempt to go back rather than stumble aimlessly forward. Try to remember landforms you passed. If you feel you are becoming lost once again, make camp as best you can.

- Under no circumstances attempt to travel at night. If you are lost in the daylight hours, chances are that you will become doubly lost at night.
- If you decide to leave your camp to seek either food, water, or obtain a better view of the surrounding country, mark a path by breaking twigs on bushes, leaving scar marks on trees or using the marking tape if you have any.
- Leave some sort of message at your base camp indicating that you are alive and where you are going. This can be scratched in sand, written with a piece of charred wood on a stone or constructed out of sticks.
- If you decide to stay firmly in the one place light a smoky fire. One large fire covered with green branches to produce the maximum amount of smoke is enough. If in heavily timbered country attempt to find a clearing of sorts as the tree canopy diffuses the smoke. There is an emergency code to signal searching aircraft. You may not be able to remember every sign but the simple SOS will do. Try to construct this in a clearing if possible and attempt to make it from material that will contrast to the ground cover. The minimum size for these letters should be 2.5 metres.

EXTREME CONDITIONS There may be occasions when a party of walkers is not lost, but simply caught by a sudden change in the weather. In the warmer months it is comparatively easy to 'sit out' the trouble for a day and then simply proceed along the planned route when conditions improve.

But when walking in high country in almost any season weather conditions can change rapidly, bringing about a rapid drop in temperature and near-freezing conditions. This does not only apply to the Tasmanian and Victorian high country areas, it is not unknown for the temperature to fall to 0°C in the New South Wales tablelands west of the dividing range in the middle of January.

In severe instances this can bring about an attack of what is known as hypothermia, a condition well known to high altitude mountain climbers. Its symptoms are a sudden loss

EMERGENCY SIGNAL CODE

I	<i>Require doctor, serious injuries</i>
II	<i>Require medical supplies</i>
X	<i>Unable to proceed</i>
F	<i>Require food and water</i>
□	<i>Require map and compass</i>
K	<i>Indicate direction to proceed</i>
↑	<i>Am proceeding in this direction</i>
SOS	<i>Emergency</i>
△	<i>Probably safe to land here</i>
L	<i>Require fuel</i>
LL	<i>All well</i>
N	<i>No</i>
Y	<i>Yes</i>
JL	<i>Not understood</i>

of co-ordination, poor sense of touch and blurred speech. In advanced stages the victim will collapse and finally become unconscious.

Thus if the weather changes suddenly the most important thing is to seek shelter out of the wind, which can cause rapid loss of temperature.

Reinforce tents if necessary with a brush shelter. Use rockforms if possible and build a fire for warmth. It is no time to start remembering the previously mentioned bushwalker's adage, 'The bigger the fool, the bigger the fire.'

If one member of the party is seriously affected he or she must be kept as warm as possible with multiple use of sleeping bags. Do not give hot drinks immediately but wait until there is some sign of recovery and an indication that bodily heat is being regained. Follow the drinks with small quantities of food.

If caught in this manner in high snow country, a snow cave can be constructed in a bank with about a 45° slope.

Any implements can be used; the heels of skis, for instance. A hole of about a metre can be tunnelled into the bank for about 2 metres. At this stage the 'burrow' is widened and deepened enough to take one or two members of a party. Take some sort of digging implement into the hole with you, just in case.

If the party has tents and the area is flat, snow blocks can be cut to surround the tent and protect it from the wind. Some high-country experts have claimed that tents are not satisfactory shelters at all for cross-country skiing trips. But one has to weigh this against the multitude of Himalayan expeditions, all of which used tents for shelter, stretching well back beyond the time when new lightweight windproofing materials became readily available.

DEHYDRATION At the other temperature extreme walkers can be severely affected by dehydration through lack of water. It can also occur in very cold dry weather because the

exertion to keep warm causes the body to lose more moisture and the dry air accentuates the problem.

However it is far more noticeable when the temperature rises. A broader discussion on the necessity for water and ways to find it is to be found in Chapter 5, Food and Water.

But as a general rule, for an easy walking day with the temperature around 25°C, about 3 litres per person is ample. With the temperature at 37°C, 5 litres should be allowed.

To translate this into instantly comprehensible terms this means that the person walking has to be prepared to carry a standard wine cask as well as the rest of his or her baggage under these conditions.

9 Time and direction

The measurement of time and obtaining direction by accurate means are not primitive skills. Of the two, direction is the most recent development, although to the Polynesians of the Pacific it is older than their awareness of time.

Obtaining time and direction without equipment is practical and in general can be more accurate than the average person's watch or compass.

Both words, 'time' and 'direction', are interrelated because if one has accurate time, accurate direction can be obtained in a matter of seconds. If one has accurate direction, from north, then accurate time is immediately practical without a watch.

The methods outlined in this chapter are applicable anywhere on the surface of the earth, but in the northern hemisphere read north for south, south for north and reverse cardinal points.

The subject of navigation has been surrounded by many technical words, necessary to its science, but in this section of the book an attempt has been made to simplify the whole subject and to avoid words which would have no meaning for the average person.

Although a compass is the accepted method of obtaining direction, it is not always reliable, nor is it of very great value in dense bush, or areas where deposits of iron affect its needle. A watch is the accepted means of measuring time, but the watch may be out of action, and therefore it is necessary to have other methods to obtain both time and direction.

'Time' is our method of measuring the intervals between events. The most regular event of our daily lives is the move-

ment of the sun, and therefore for everyday purposes time is measured by the sun's movement. The stars provide a more accurate method of measurement and are used by navigators and astronomers. 'Direction' is the line or course to be taken, and in this case can be considered as from north or one of the cardinal points of the compass.

Sun movement

As you know, the sun crosses the imaginary north-south line (meridian) every day when it reaches its highest point (zenith) above the horizon.

Therefore when the sun is at its highest point in the sky it is north or south of you, depending upon your position on the earth's surface, and the sun's position relative to the earth's equator.

For all practical purposes there are twenty-four hours between each sun crossing of your north-south line, or meridian. During the twenty-four hours the earth will have revolved apparently 360 degrees; therefore it will move 15 degrees for each hour, or one degree in four minutes. This is very convenient to know, because if you know the north or south accurately, you can easily measure off the number of degrees the sun is from the north-south line, and this will give you the number of hours and minutes before, or after noon. These measurements must be made along the curved path of the sun, and not on a horizontal or flat plane.

Time from the sun with compass

A means of measuring degrees – arms must be fully extended.

Hand at full arm's length, fingers widely spread	22°
Thumb turned in	15°
Closed fist	8°
From second knuckle to edge of fist	3°
Between to centre knuckles	2°

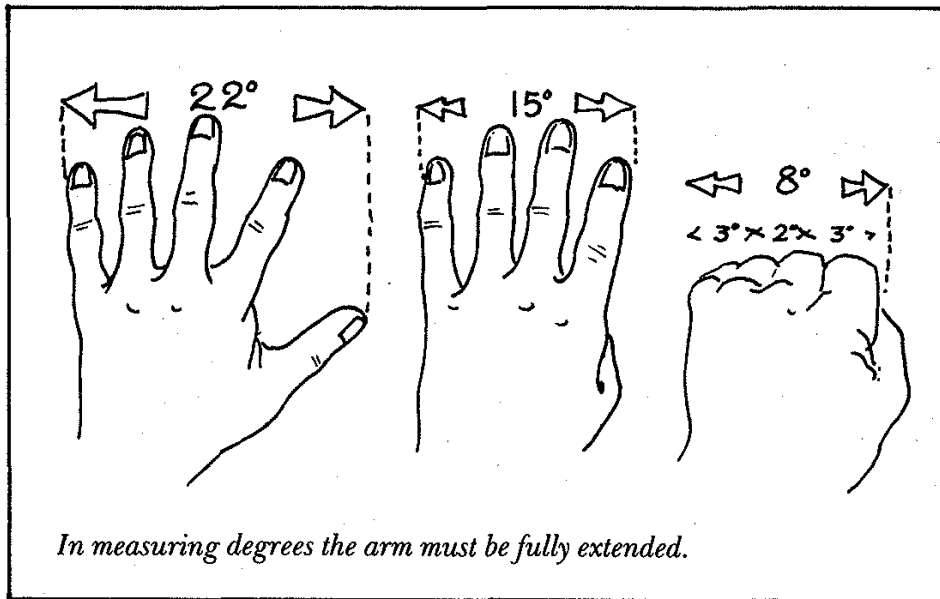

These vary slightly like your personal dimensions and for accuracy should be accurately checked by each individual with a compass.

By this means, if you have a compass, time can be easily read from the sun's position. This should be possible to within four or five minutes. Decide from your compass your true north-south line and remember to make allowance for the magnetic variation from true north. Measure the

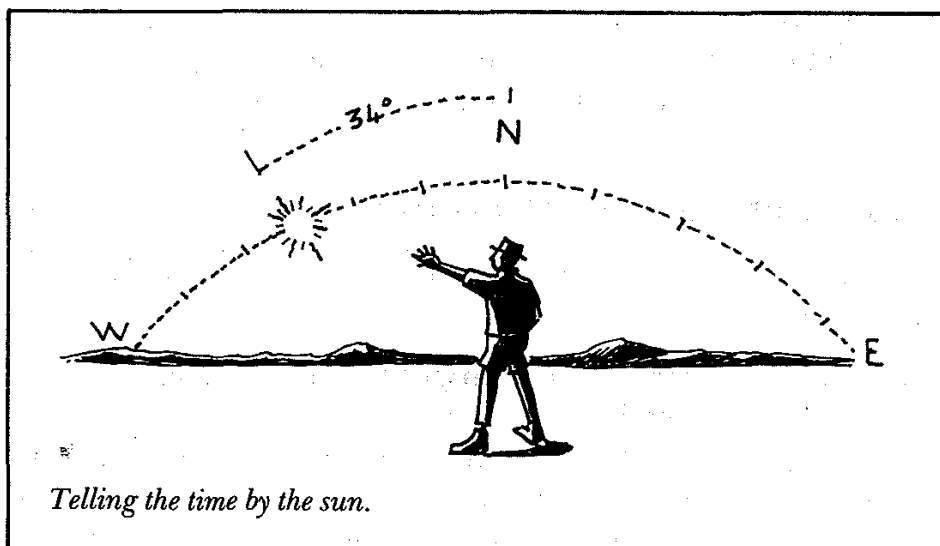

number of degrees the sun is from this imaginary line, and multiply the number of degrees by four to obtain the number of minutes.

Accurate direction from the sun with a watch

The method of obtaining direction from a watch by pointing the hour hand (or 'twelve o'clock depending upon which hemisphere you live in) is not accurate, but only approximate.

The accurate method, knowing the time, is to calculate the number of degrees changed to minutes in time, before or after noon, and then to measure from the sun's position along the curved path of the sun through the sky. Even if you make no allowance for the two corrections, you will be accurate within five to eight degrees and if you make the two corrections for time you will be accurate to less than one degree.

To give an example: It is 2.16 p.m. by your watch, therefore the sun is to the west of the north-south line. 2.16 p.m. means that the sun has travelled 136 minutes of time past the north-south line. It travels one degree along its curved path in the sky every four minutes of time, so that it is 34 degrees along its path past noon. Measure this back along the sun's path and you will have true north.

Cardinal points and bearings

Having found the true North, you can find any bearing from true North very easily and within five degrees of error. If the bearing you want is less than 180°, face east, and stretch out your left arm to true north. Raise your right arm along your side till there is a perfectly straight line along both arms. Your right arm is now pointing to south or 180 degrees true. Bring the two arms together evenly, and you are pointing to east or 90 degrees true, and you can then measure the number of degrees from these cardinal points to the bearing you require. By facing west, and pointing

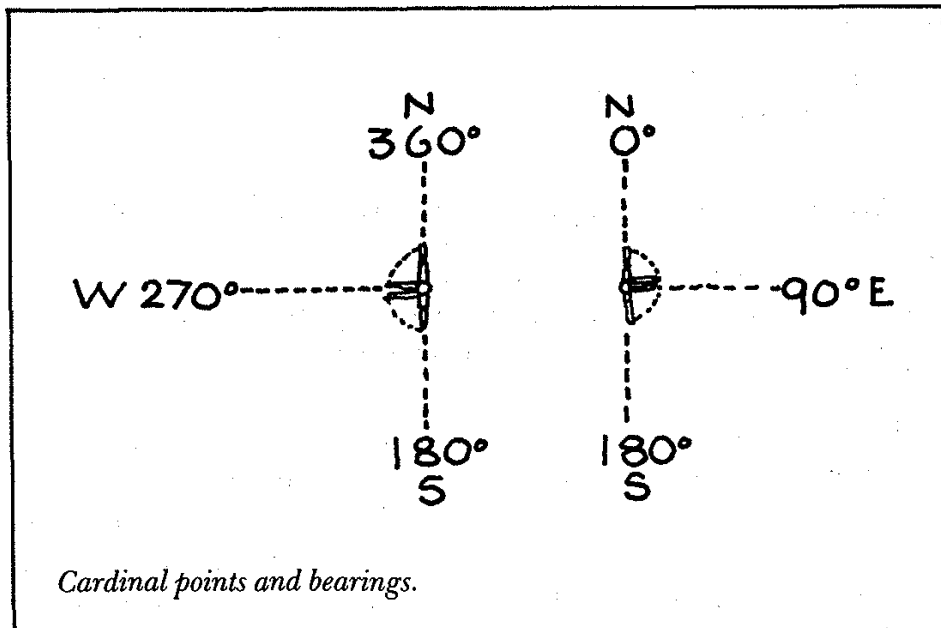

your right arm to the north and your left to south you can get bearings greater than 180 degrees.

Finding north-south line without compass or watch

Knowing that the sun is at its highest point in the sky at mid-day, and that this point is on the north-south line means that by finding where this position will be, will give you true north.

You can do this by measuring the points of shadow made by the top of a fixed stake. These points of shadow may give you a curved line either concave or convex to the stake. Continue the curve made by the points of shadow, and then draw a circle on the ground round the base of the stake. Where the curved line cuts the circle will be accurate east and west, and a right angle from these two points will be an accurate north and south line.

In the illustration you see the stake, and points of shadow recorded over an hour in the morning. The dotted line is a continuation of the curve made by the points, and the intersection of this curved line with the circle gives you east and

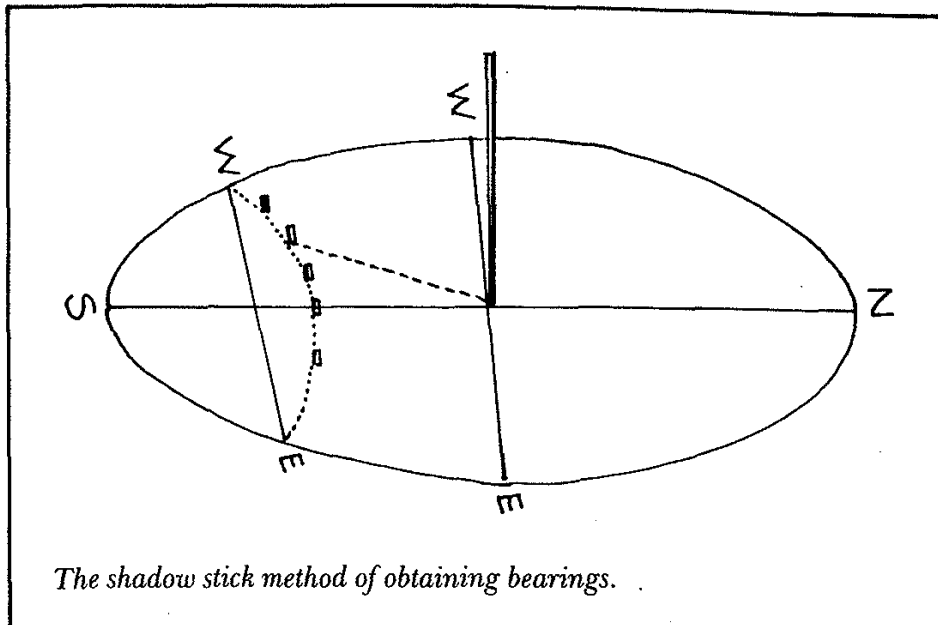

west. If north of the equator the cardinal points will be reversed.

This shadow-stick method is very accurate, if done over a period of an hour or two.

East-west line – during equinoctial periods

You will find from the foregoing that it is actually easier to find the true east-west line than the north-south. The idea of always working from, or to, north is largely conventional. The top of every map is assumed, unless marked otherwise, to be north. All bearings are measured clockwise from true north, but in actual practice it is often easier to find one or other of the cardinal points, rather than concentrate on finding the north point. An instance is the ease with which the east-west line can be discovered.

There are two days in the year when the points of shadow will form an accurate east-west line throughout the whole day. These two days are 21 March, and 21 September, the days when the sun is over the equator. On these two days the sun is at right angles to the axis of the earth, and therefore

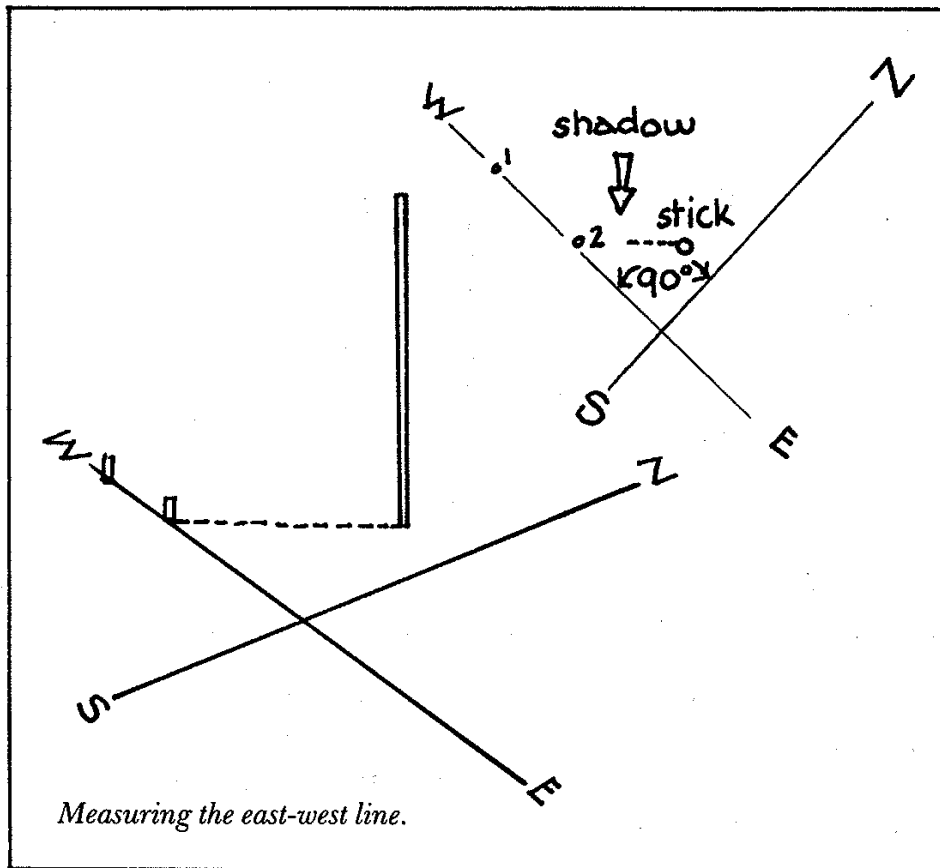

directly over the equator, and no matter where you are on the earth's surface the shadows will move true east and west on these two days. Because of this if you mark a point of shadow by putting a peg into the ground, and then, five minutes later, mark the new position of the same shadow you will have a perfect east-west line. For general purposes if in less than 40° north or south latitude this method will serve you for about two or three weeks either side of the equinoctial periods with reasonable accuracy, so that on any day between 1 March and 14 April or 1 September and 14 October you can assume that the shadow line is very nearly a true east-west line. At all other periods or when you want greater accuracy you will have to work out the curve and extend it to the edges of the circle as in the preceding section.

The points of shadow move accurately true east and west on 21 March and 21 September.

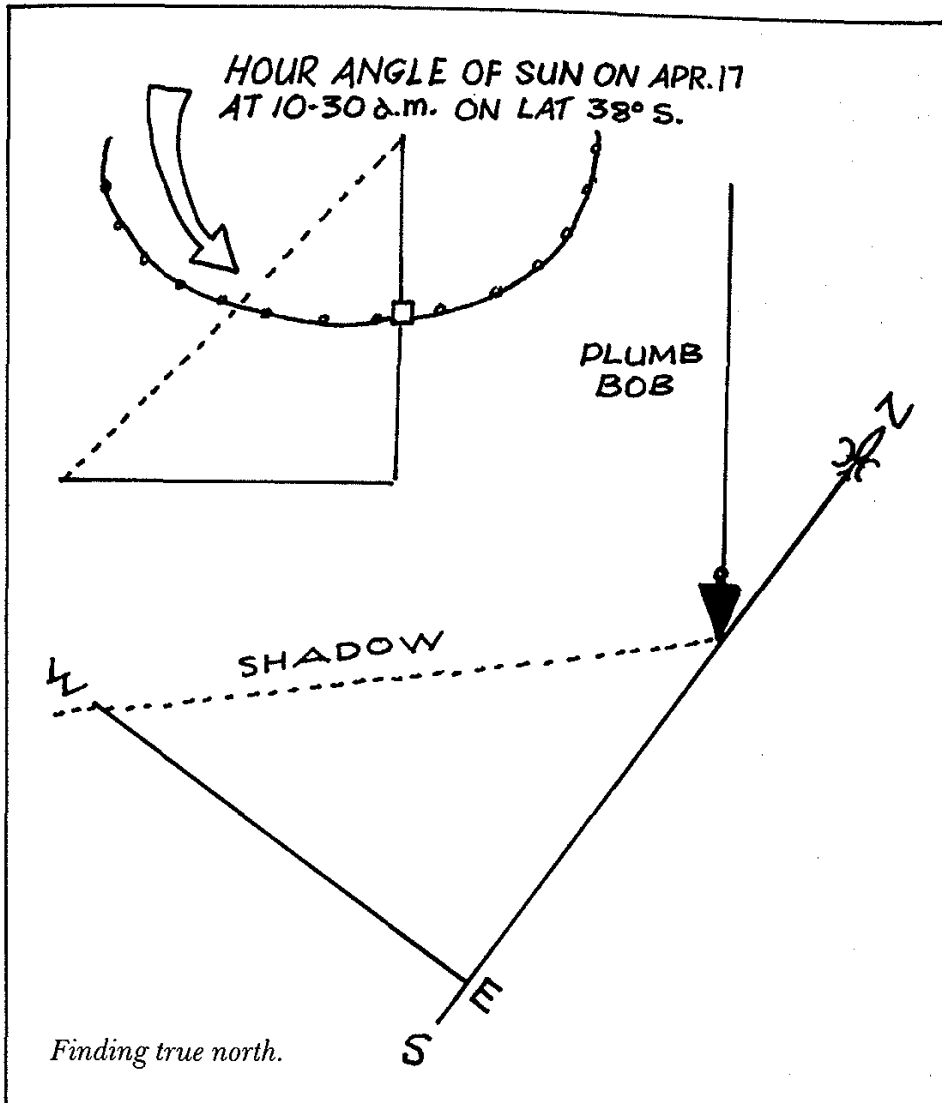

An extremely accurate method of finding true north is to work out the hour angle of the sun and transfer this hour angle to the shadow thrown onto the ground from the string of a plumb bob.

To find the hour angle, use the method given in the section on the sun compass and extend from the shadow of the stick the hour angle correct for your latitude and date.

The sun compass diagram does not require to be set correctly to work out the hour angle. Any direction will serve for the imaginary north-south line.

When the triangle has been worked out, a corresponding triangle is made on the correct side of the shadow from the cord of the plumb bob.

You should work out the hour angle on the sun compass on the ground about fifteen minutes ahead of the watch time, so that when you have worked on the diagram and made the necessary time and longitude corrections, you will be able to plot the hour angle at precisely the right moment on the shadow. This method, if done accurately and corrections of time for longitude and equation worked out, should

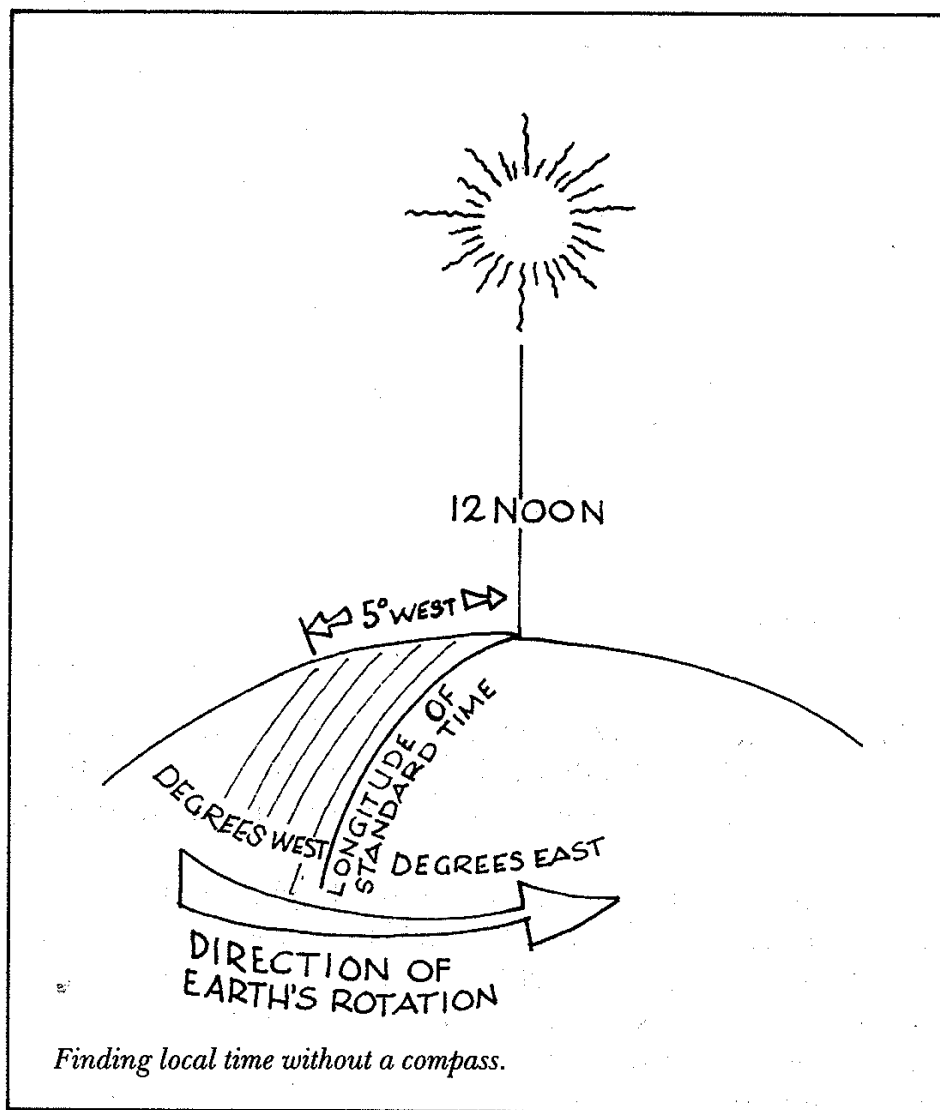

be correct to within less than a quarter of a degree, or one minute of time.

Finding local time without compass

It is apparent that if you can find north-south by the method given from the shadow of the stick that you can then work out the number of degrees the sun is off the north-south line and thereby discover the correct local time, provided you know the longitude of standard time, and the longitude of your position.

The sun's path through the sky

To be able to accurately measure the sun's path along the sky you must know how high it is at its highest point (zenith), and to find this out, you should be able to discover the sun's position north or south of the equator for any day of the year.

This position of the sun is called 'Declination.' As you know, the sun is farthest north on 21 June, crosses the

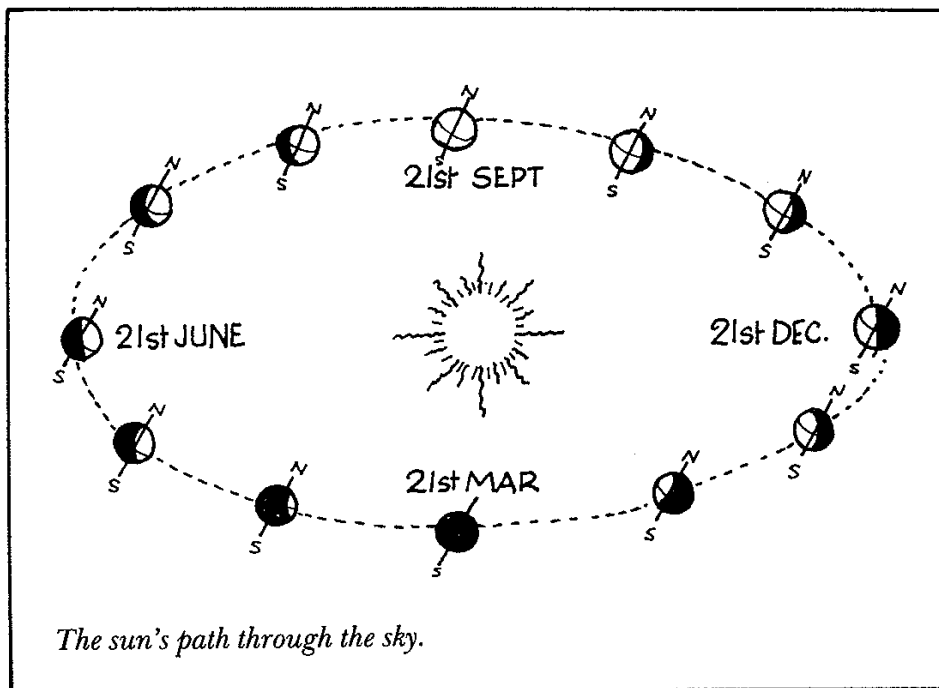

equator 21 September, farthest south 21 December and recrosses the equator on its way north on 21 March. This is caused by the inclined angle of the axis of the earth in relation to its path round the sun.

Circle of declination

The degree, or slope, of the inclined path is approximately $23\frac{1}{2}^\circ$, so that when the sun is farthest north it is overhead $23\frac{1}{2}^\circ$ north of the equator, and when farthest south it is overhead $23\frac{1}{2}^\circ$ south of the equator.

It is possible to work a circle of 'declination' showing you the path of the earth round the sun, and the reason.

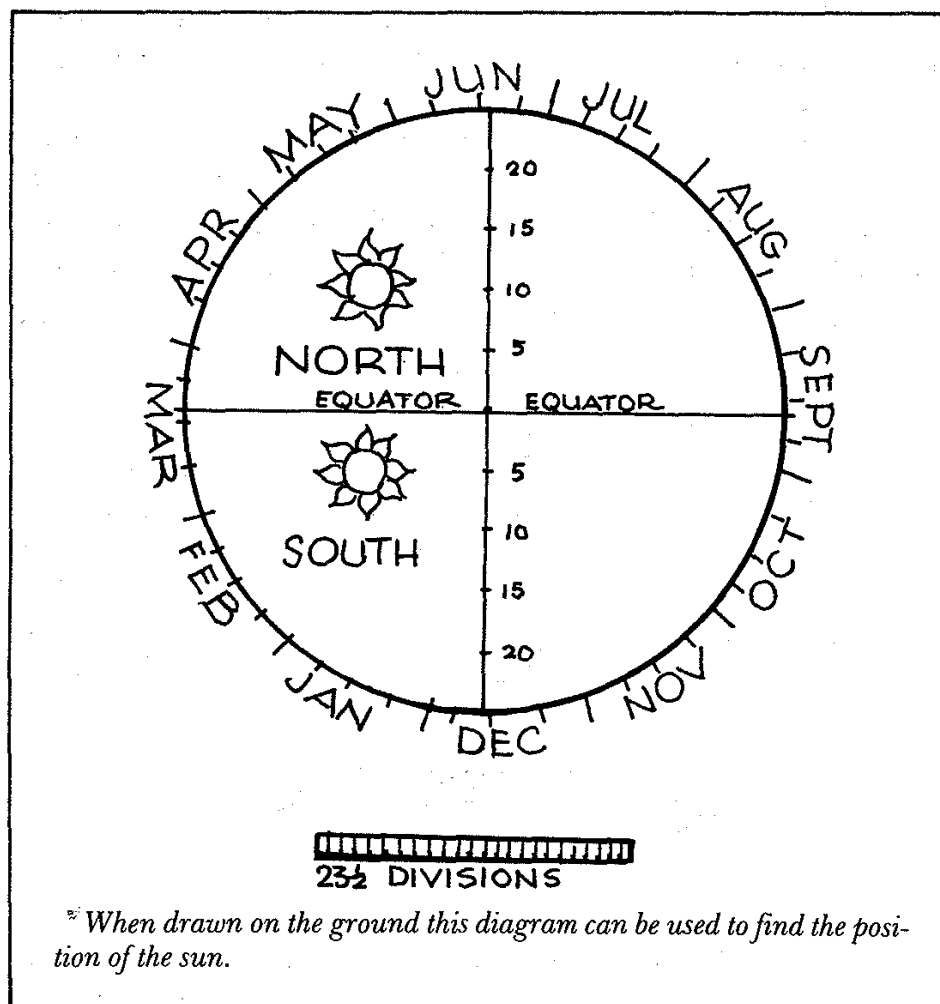

You can draw this diagram on the ground. Take a straight stick and cut $23\frac{1}{2}$ divisions along its length. The size of the divisions must be absolutely equal.

If you use the width of your knife blade, or some equally simple measure, it will serve. With this stick as a radius, draw a circle on the ground, and divide the circle into four quarters with straight lines that cross the centre of the circle.

Now divide each quarter of the circumference of the circle into three equal divisions. Mark these June, December, March and September as shown in the illustration. Now divide each month into four smaller equal divisions. These represent the four weeks of the average month.

Draw a thick line from the start of the fourth division of June to the start of the fourth division of December, and from the start of the fourth division of September to the start of fourth division of March.

These lines should intersect each other in the centre of the circle. The lines from June to December represent the north-south line, and the line from March to September the equator.

For any day of the year find the approximate day on the outer circle and draw a line parallel to the equator line to the north-south line, and then simply measure off with your stick the number of nicks from the equator line, starting in the centre, to the date line. If the sun is on the June side of the equator line it is north of the equator; if on the December side it is south.

You should be accurate to within a quarter degree. This accuracy is needed for latitude work, but not necessary for the sun clock.

The sun's height above the horizon

To the sun's declination you must make an allowance for your own latitude. For instance, if you are in latitude 42°N and the date is 21 April, the sun will be 12° north, which means that at its zenith it will be 60° above the horizon. To work this out subtract your latitude from 90° , and add the

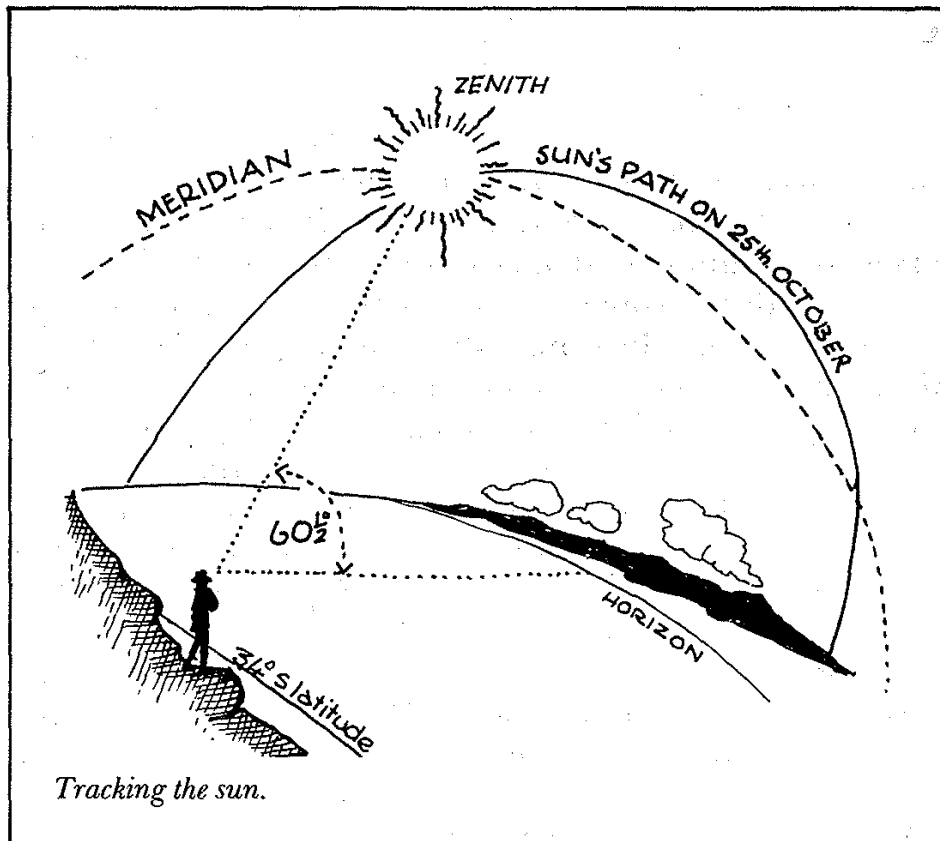

sun's declination. If the sun is on the other side of the equator, subtract the declination.

Equation of time – and corrections to standard time

Each day every longitude of the earth passes under the sun, but because of the slight variation in the earth's path, the exact moment when the sun passes over the meridian of longitude is not precisely at twelve o'clock every day. The difference may be as much as 16 minutes of time before twelve o'clock on your clock time and fourteen minutes after twelve o'clock.

This passage of the sun over the imaginary north-south line is called 'meridian transit' and as you will see it differs from clock time throughout the course of the year, except for four days (16 April, 15 June, 30 August, 25 December).

For convenience, the time of meridian transit is averaged out over the year, and the average is called 'mean' time.

The sun's passage of the meridian time is called 'solar' (sun) time. The correction of time of the two is called 'equation of time.'

The following simple table on meridian transit can be shown in the form of the figure '8' for your easy memorising.

Time of Meridian Transit

January	1	12.03	May	1	11.57	Sept.	3	11.59
	6	12.06		6	11.57		8	11.58
	11	12.08		11	11.56		13	11.56
	16	12.10		16	11.56		18	11.54
	21	12.11		21	11.56		23	11.53
	26	12.13		26	11.57		28	11.51
	31	12.14						
Febr	5	12.14	June	5	11.58	October	3	11.49
	10	12.14		10	11.59		8	11.48
	15	12.14		15	12.00		13	11.46
	20	12.14		20	12.01		18	11.45
	25	12.13		25	12.02		23	11.44
				30	12.03		28	11.44
March	2	12.12	July	5	12.04	Nov	2	11.44
	7	12.11		10	12.05		12	11.44
	12	12.10		15	12.06		17	11.45
	17	12.09		20	12.06		22	11.46
	22	12.07		25	12.06		27	11.48
	27	12.06		30	12.06	Dec	2	11.49
April	1	12.04	August	4	12.06		7	11.51
	6	12.03		9	12.05		12	11.54
	11	12.01		14	12.05		17	11.56
	16	12.00		19	12.04		22	11.58
	21	11.59		24	11.59		27	12.01
	26	11.58		29	12.01		31	12.03

A figure eight drawn to the proportions shown and with the four dates remembered when meridian transit coincides with mean time will give reasonably accurate corrections.

Note: The four dates when there is no correction are 16 April, 15 June, 30 August and 25 December.

The top section of the figure 8 is about one-third the size of the lower half. The horizontal line is divided into three five-minute sections to right and left, and the right side marked plus to mean that the sun is ahead of mean time. The left is marked minus, the sun is behind mean time.

The application of this 'equation of time' correction will be required if you want to get accurate time from the sun, and also for correction to the compass-sun clock.

Longitude corrections

The other correction which you will have to make to solar time is a correction for longitude. Time for clocks on various parts of the earth's surface is called 'standard time,' and is based upon the longitude convenient for a large tract of country.

In England, time is based on Greenwich, hence the term 'Greenwich mean time.'

In other large land masses such as America, Africa, Russia and of course Australia, standard time may be defined as Eastern Standard Time, Central Standard Time, Western Standard Time, etc.

The areas of the earth and the meridian of longitude on which their standard time is based are as follows:

12h.	E 180	Siberia (E. Long. $157\frac{1}{2}$ to $172\frac{1}{2}$) Fiji Islands.
11h. 30m.	E $172\frac{1}{2}$	New Zealand. Norfolk Island, Nauru Island.
11h.	E 165	New Caledonia, New Hebrides, Ocean Island, Solomon Islands, Siberia (E. Long. $142\frac{1}{2}$ to $157\frac{1}{2}$).

10h. 30m.	E 159	Lord Howe Island.
10h.	E 150	Tasmania, Victoria, New South Wales, Queensland, British New Guinea, Guam, Siberia (E. Long. $127\frac{1}{2}$ to $142\frac{1}{2}$).
9h. 30m.	E $142\frac{1}{2}$	South Australia, Northern Territory.
9h.	E 135	Broken Hill area of New South Wales, Manchuria, Japan, Dutch New Guinea.
8h.	E 120	All coastal area of China, Philippine Islands, North Borneo, Timor, Western Australia, Celebes.
7h. 30m.	E $112\frac{1}{2}$	Sarawak, Java, Madura, Bali, Lombok, Borneo.
7h. 20m.	E 110	Federated Malay States, Straits Settlements.
7h.	E 105	Indo-China, Thailand, Southern Sumatra.
5h. 30m.	E $82\frac{1}{2}$	India (except Calcutta 5h. 53m. 20.8 S.), Ceylon.
4h.	E 60	Russia (Long. 40° E. to $52\frac{1}{2}^{\circ}$ E.).
3h. 30m.	E $52\frac{1}{2}$	Iran
3h.	E 45	Iraq, Eritrea, Somaliland, Madagascar, Russia (West of Long. 40° E.).
2h. 45m.	E $41\frac{1}{2}$	Kenya, Israel, Syria, Egypt, Union of South Africa.
1h.	E 15	Malta, Tunisia, Libya, Nigeria, Cameroons, French Equatorial Africa, Norway, Sweden, Germany, Italy.

0h.	0	Great Britain, Northern Ireland, Eire, France, Belgium, Spain.
+4h.	W 60	Eastern Part of Canada, U.S.A., South America.
+5h.	W 75	Parts of Canada and U.S.A., including Quebec and New York.
+6h.	W 90	Central States of Canada and U.S.A.
+7h.	W 105	Central America. Mountain parts of Canada and U.S.A.
+8h.	W 120	West coast of Canada and U.S.A

To make the necessary longitude corrections, you must know whether you are set east or west of the meridian on which standard time for the locality is based.

If you are east your sun will be ahead and you must deduct four minutes for each degree you are east of the meridian of standard time. If you are west your sun time will be later than the standard meridian and you must add four minutes for each degree you are west.

The corrections for the equation of time and for longitude are necessary to correct conversion of sun time to standard time for accurate direction, and also for accurate reading of directions and time from the sun compass. With these corrections you should be able to get local standard time to within two minutes, and a bearing accurate to within an error of one half degree, using no equipment whatsoever.

Time

Sometimes a country will move its time back an hour from the standard time to get more daylight in summertime, and this change, generally called daylight saving time, must also be remembered when making corrections to solar time.

The four 'times' you now know are:

Solar Time or Sun Time: Local time of sun over the north-south line.

Mean Time: Average of solar time over twelve months.

Standard Time: Application of mean time to a given area of the earth's surface.

Daylight or Summer Time: A local adjustment to standard time.

There is a fifth 'Time' you will have to learn, and this is 'sidereal' or 'star' time.

If anyone asked you how many times the earth revolved on its axis between midday of New Year's Day of one year, and midday of New Year's Day the next year you would probably say $365\frac{1}{4}$ times . . . and you would be wrong.

The earth revolves on its axis $366\frac{1}{4}$ times.

The earth 'loses' one revolution in its path around the sun over the year and as a result the sun only crosses the meridians of the earth $365\frac{1}{4}$ times. This means that while the sun will only cross Greenwich $365\frac{1}{4}$ times a year, a star, which is far outside the solar system, will pass $366\frac{1}{4}$ times every year.

For this reason star or sidereal time is used by astronomers as being more accurate than solar time.

There is an extra day to be squeezed into a 'star' year, a star day is shorter by 3 minutes 56.6 seconds than a sun day. You can work it out for yourself. There are 1440 minutes in a twenty-four-hour day and these have to be shared by all days in a star year and that means that there are nearly four minutes less in a star day than in a sun day.

One degree equals four minutes of time, and so the stars advance roughly one degree farther ahead each night.

Sidereal or star time or the star charts commence for each year at the day of the Autumnal Equinox, 21 September, and for general purposes you can say the stars gain two hours every calendar month.

Direction from the stars

In the northern hemisphere, direction from the stars is easy.

Polaris, the Pole star, is very nearly directly over the North Pole, and therefore wherever you see it in the sky is true north.

In the southern hemisphere there is no star over the South Pole and finding direction is a little more difficult.

One of the most popular methods is from the constellation Crux, or the Cross, better known as the Southern Cross. There are many stars which appear to make the shape of a cross in the sky, and therefore it is essential, if you live in the southern hemisphere, that you learn to identify the Southern Cross beyond any shadow of doubt.

Look along the Milky Way, which is unmistakable, and you will find a dark patch without a single star. This is commonly called the Coal Sack, and the Southern Cross lies right on the very edge of the Coal Sack.

To make identification more certain, the Southern Cross should show you five stars, the fifth less bright than the others, and nearly in line with the foot star, and one of the arms. Another certain identification is the two pointers, two stars of the first magnitude lying always to the left-hand side of the Cross (when viewed as if the Cross was in a vertical position).

The longest axis of the Cross towards the foot points to the Celestial South Pole. That is, to a position over the earthly South Pole.

This, using the length of the Cross from head to foot, is almost exactly four and a half times the length of the Cross commencing from the foot.

You can measure this with fair accuracy by holding the hand at arm's length, and using the thumb and forefinger as a pair of calipers to measure the length of the Cross.

Another indicator of true south, suitable for moonless nights, is the two Magellan Clouds which form the base of an imaginary equal-sided triangle, the apex of which is over the South Pole. On bright nights, when these two clouds are not visible, the two very bright stars, Achenar and Canopus, also are the base of an equal-sided triangle with its apex over the South Pole.

Accurate time from the stars

The star maps shown on pages 310-312 show the position of the brightest stars in their various constellations. The numbers 0 to 24 indicate the position of the stars at midnight at Greenwich on 21 September, when the star year commences.

0 means midnight at Greenwich, and every number means one hour difference from Greenwich.

Thus ALGOL in the constellation PERSEUS is on the radial line numbered 3, which means that it is three hours ahead of Greenwich.

This position of the stars in time from Greenwich is called their right ascension, and their position between the poles and the equator either north or south is called their declination.

Declination is latitude, and right ascension is longitude.

The declination of the stars does not vary (as does the sun) throughout the year.

The Polynesians observed this, and regarded the stars as 'fingers' pointing down to the earth and always passing over the same places the earth revolved beneath them.

With the aid of the star map, it is easy to find and identify any star almost directly overhead. It may be slightly north or south but should not be east or west.

To find a point directly overhead, stand upright, with your head thrown well back. Rotate the body through a series of half circles and you will see the stars overhead appear to move in arcs.

The centre of the circle which the arcs form will be the point in the sky directly over your head.

Having recognised the overhead star from your star map, work out its right ascension, and add two hours for every month, or half an hour a week and four minutes for every odd day till the next 21 September, and add this to the time of right ascension.

Example. The star Antares, the very bright star in the Scorpion, you read as 16 hours 25 minutes right ascension.

NORTH POLAR CHART

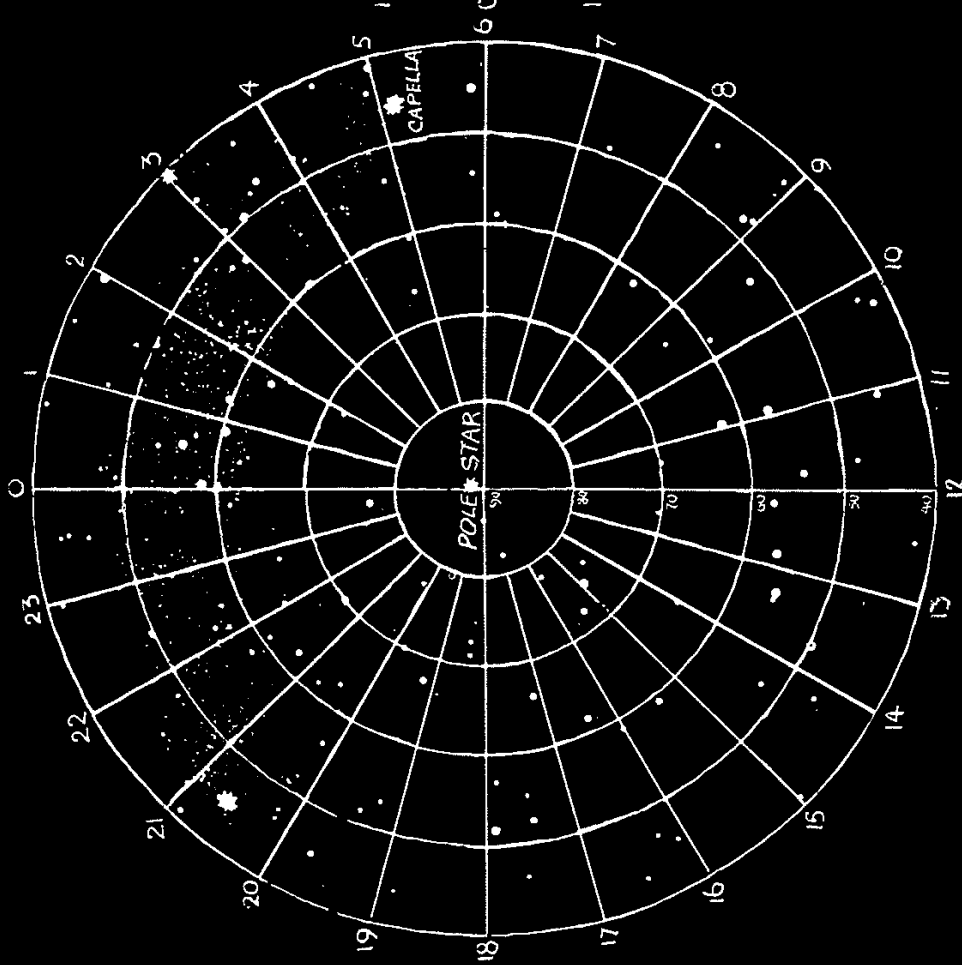

STAR POSITIONS - MIDNIGHT MARCH 2ND.

MAGNITUDES 1 2 3 4

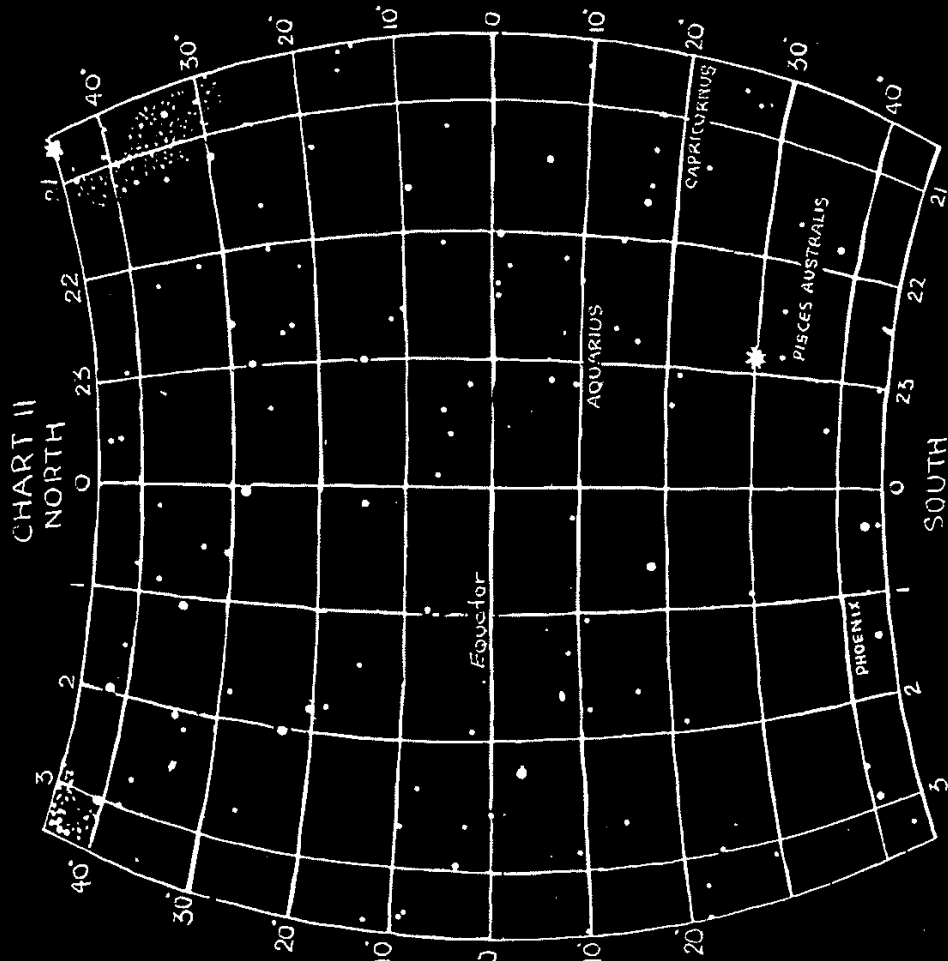

CHART II
NORTH

SOUTH

CHART IV
NORTH

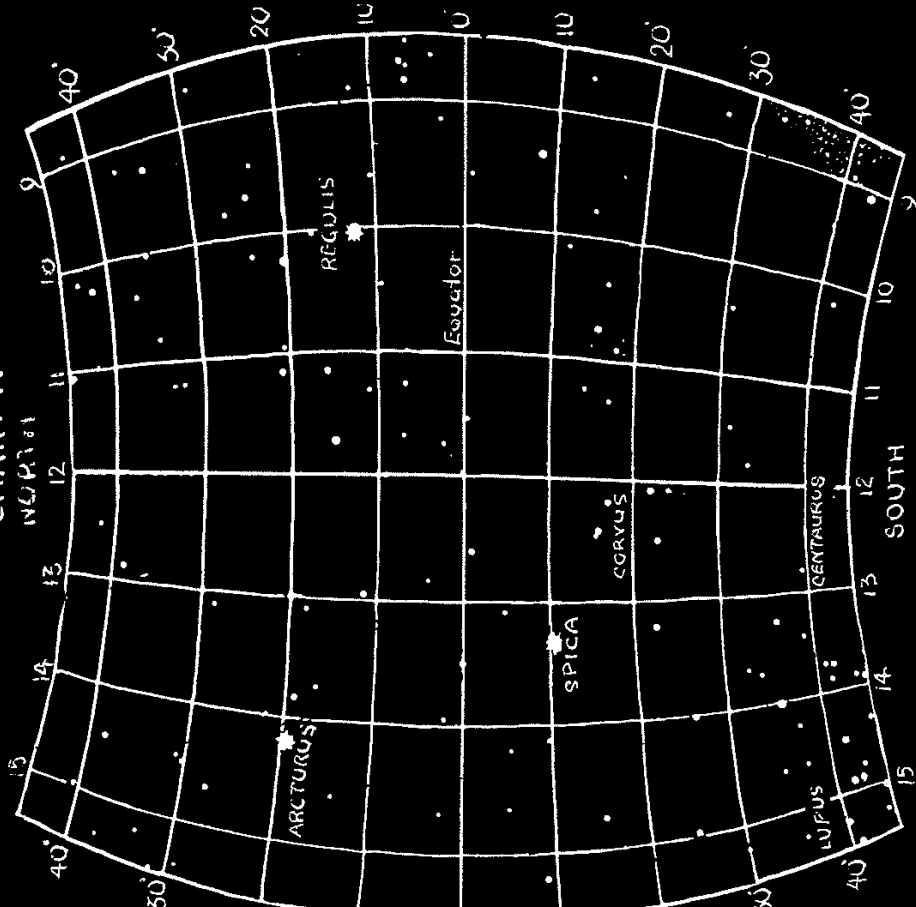
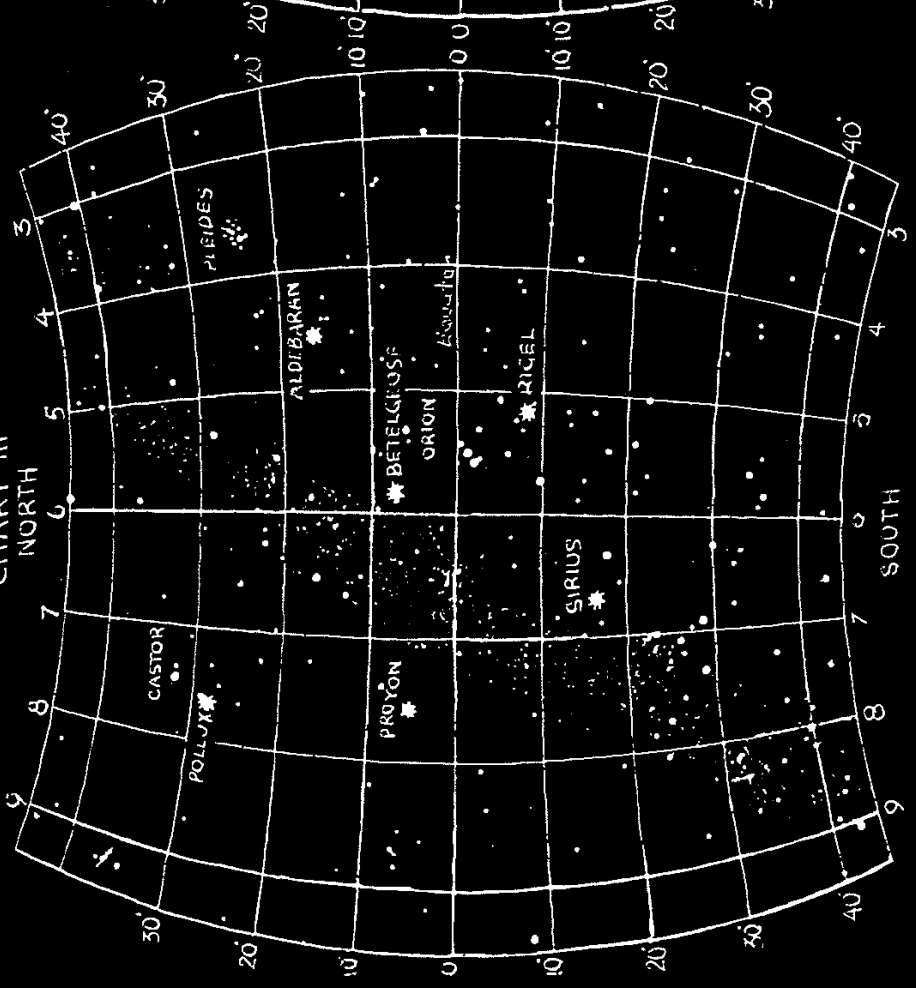

CHART III
NORTH



MAGNITUDES 1 2 3 4

★ ● ● ● ●

SOUTH POLAR CHART

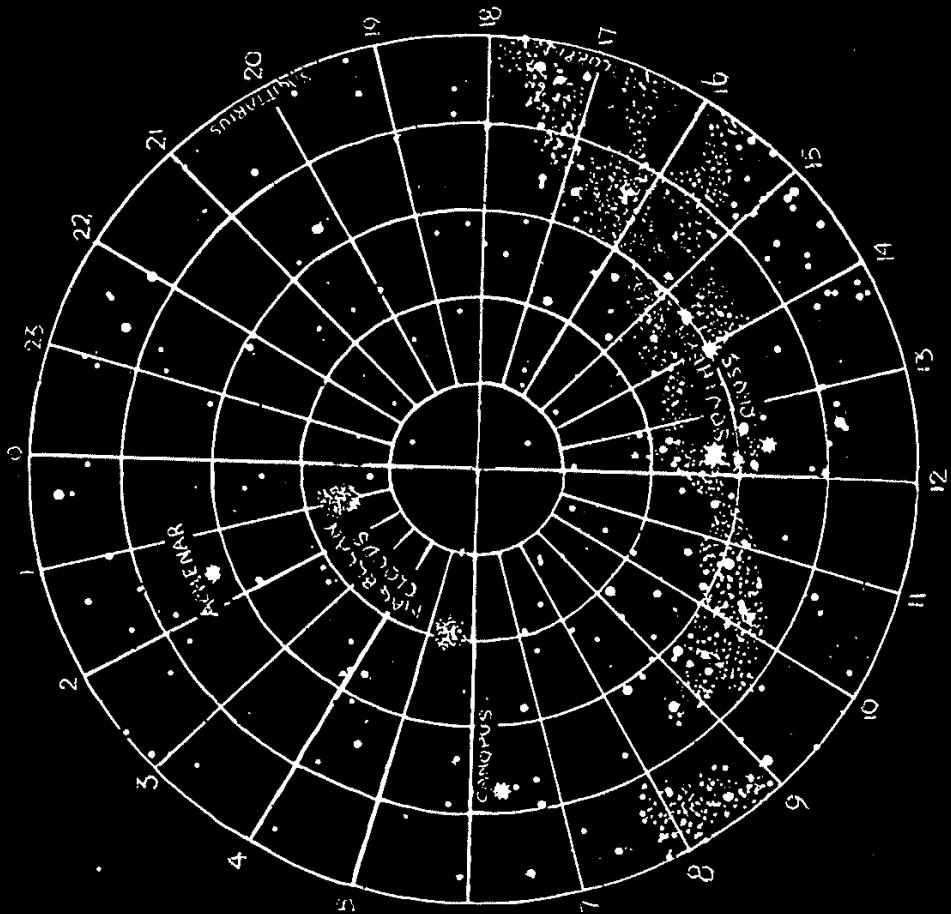
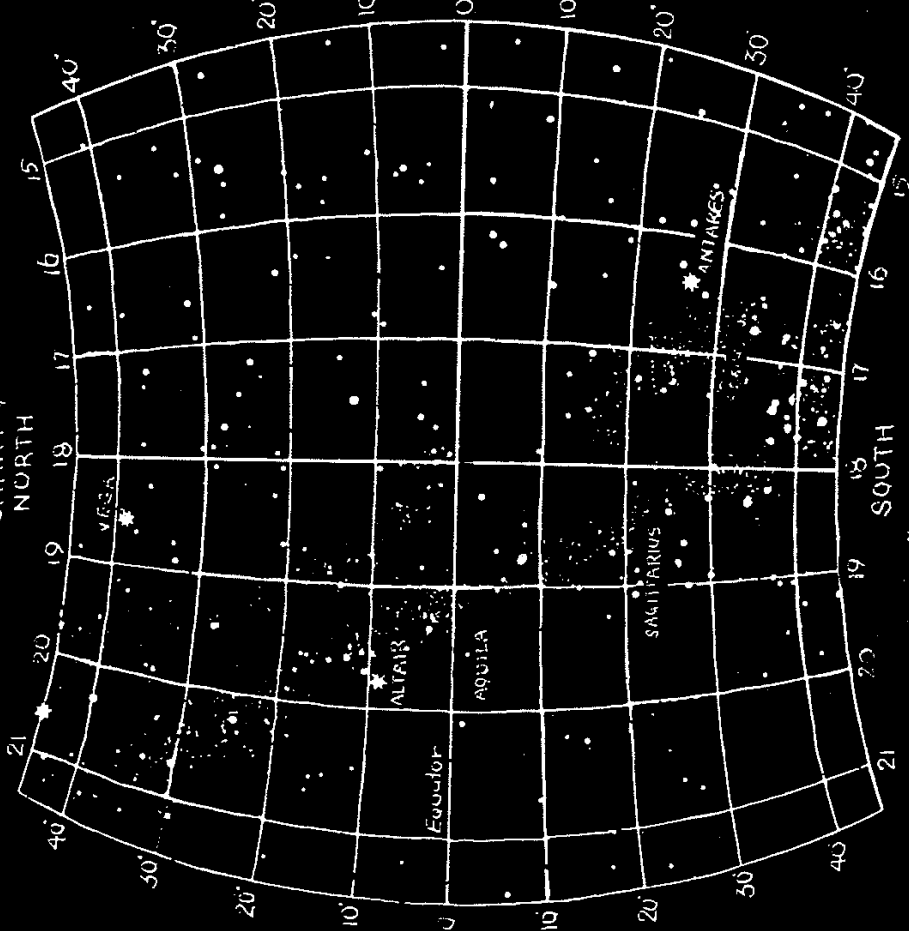

CHART 7
NORTH



MAGNITUDES 1 2 3 4

The date if it is overhead is 25 March. From 25 March to September 21 there are five months, three weeks and four days, which equal a correction of 11 hours 46 minutes. This added to the right ascension of 16 hours 25 minutes gives a total of 28 hours 11 minutes. Because the total is greater than twenty-four hours you must deduct the twenty-four hours and the result is 4 hours 11 minutes (a.m.) Greenwich. To this you must make correction for your longitude.

This method is applicable in all latitudes and gives reasonable accuracy.

TIME FROM THE STARS - NORTHERN HEMISPHERE In the northern hemisphere the stars appear to revolve anti-clockwise in the sky, and you must remember this when reading time from the stars at night. Imagine the Pole star (Polaris) is the centre of a twenty-four-hour clock dial, and the hours are numbered from midnight 24 hours, anti-clockwise with 6 hours

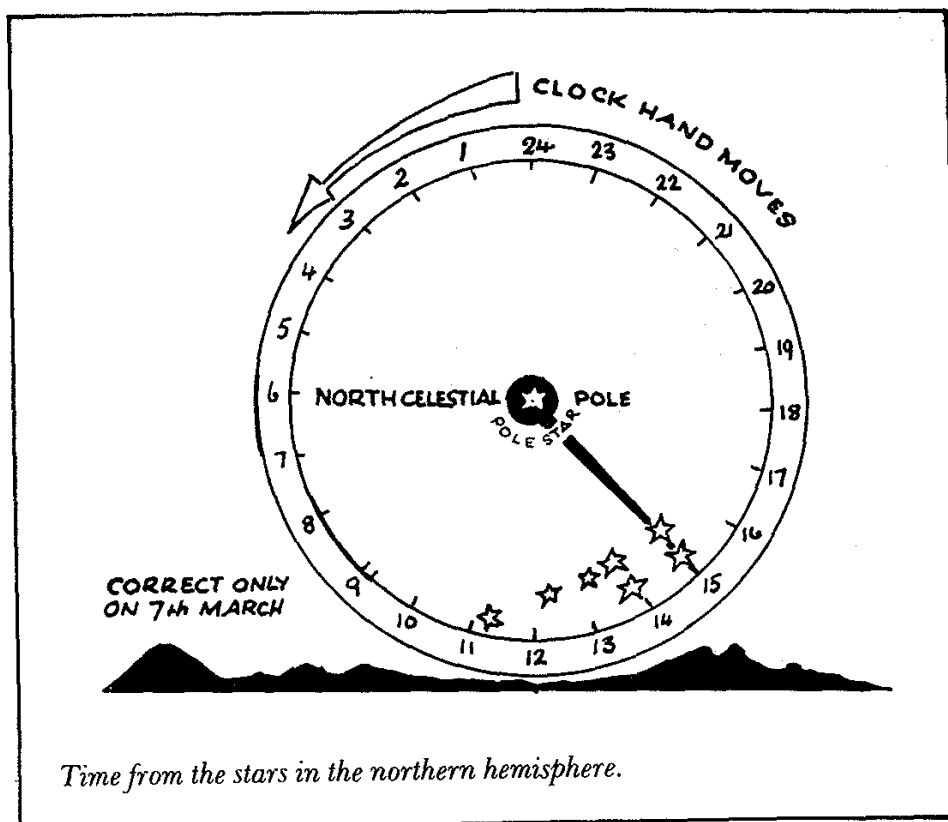

at the left and horizontal with the Pole star, twelve o'clock immediately below the Pole star, and eighteen hours at the right, horizontal to the Pole star. The brightest stars, Alpha and Beta, in Ursa Major (opposite the handle of the Big Dipper) or plough are the hour hands.

It gives correct time only on one day in the year, 7 March, thereafter it gains 4 minutes a day, or two hours a month, so that if it reads fifteen hours on 1 June, it will be seven and a half hours fast and the correct time therefore will be 7 hours 30 minutes.

SOUTHERN HEMISPHERE In the southern hemisphere the stars appear to revolve clockwise. The Southern Cross is the hour hand of a twenty-four-hour Sky Clock, and the centre of the dial is four and a half times the length of the Cross towards the foot along the longest axis of the Cross. This clock is cor-

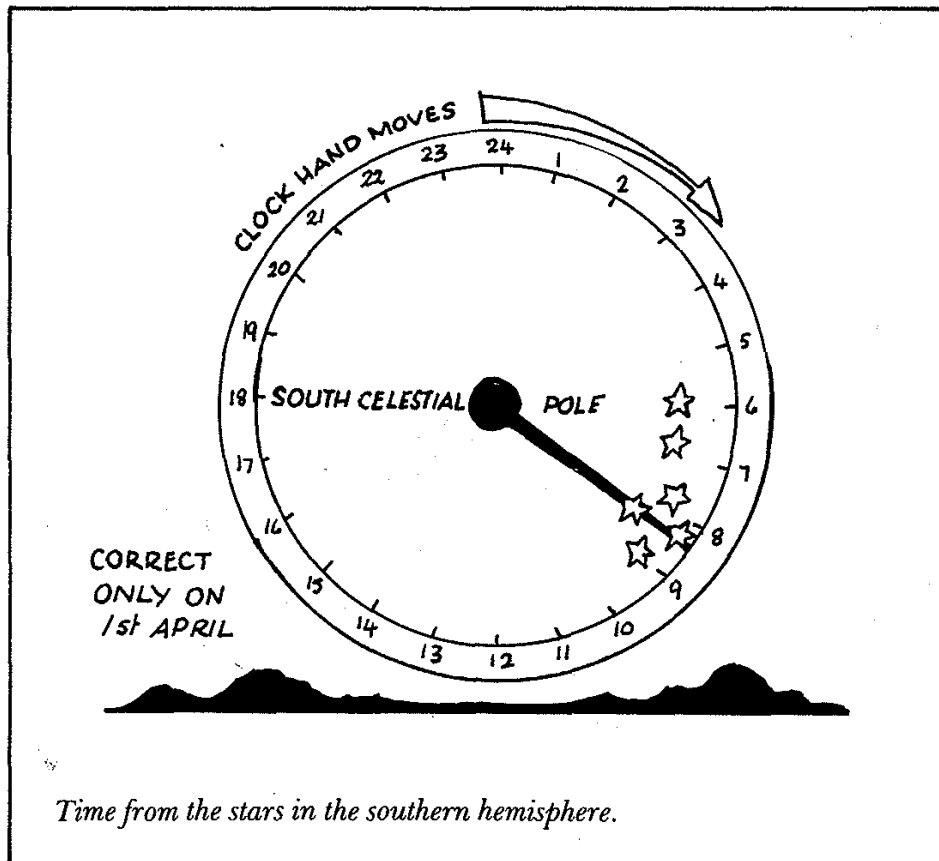

rect on 1 April, and thereafter it gains at the rate of 4 minutes a day or two hours a month, so that if it read 8.20 on 1 September it will be ten hours fast, and therefore the correct time will be 22 hours 20 minutes, or 20 minutes past ten at night.

Bibliography

Australian Fisherman's Fish Guide, Neville Coleman, Bay Books.

A profusely illustrated guide to most of Australia's fish species, with comments on their edible qualities.

Australian Outdoors Good Camping (revised edition), Federal Publishing Co., publishers of *Overlander* magazine.

A magazine containing a multitude of camping tips for both the novice and advanced bushwalker as well as for those who like to travel by car or caravan. Also covers snow country camping.

Australian Traditional Bush Crafts, Ron Edwards, Summit Books.

Stockwhips, bush chairs and huts, cooking and fence-making.

Bushwalking & Camping: Paddy Pallin's handbook on Australian Bushcraft, Paddy Pallin, published by author.

A useful pocket guide to all aspects of bushwalking in Australia.

Complete Book of Australian Birds, Reader's Digest.

Too bulky for the bushwalker, this is the best guide to Australia's birds. All species are illustrated.

Complete Book of Australian Mammals, Australian Museum in conjunction with Angus & Robertson.

A fully illustrated guide to all Australia's mammals with precise text.

Dangerous Animals and Plants of Australia, Struan Sutherland, Rigby.

Mainly aimed at children this is a handy almost pocket, guide to common dangers in the bush and on the seashore.

Field Guide to Australian Birds, Peter Slater, Rigby.

A comprehensive two-volume work well illustrated with paintings and diagrams.

Field Guide to Fungi of South Eastern Australia, Ross Macdonald and John Westerman, Nelson.

Fully illustrated guide to common species of fungi with indications (where known) of their toxic qualities.

Forest Trees of Australia, Division of Forest Research, CSIRO, Nelson.

Identification of our major tree species.

National Parks (Discover Australia's), Michael and Irene Morcombe, Lansdowne.

A well-written and interesting guide to all our better-known national parks.

Poisonous Plants of Australia, S. L. Everist, Angus & Robertson.

Plants that can either kill or make a person sick; what to avoid in the bush.

Spiders, Barbara York Main, Collins.

Complete guide to all Australia's venemous and non venemous species with descriptions of their habits and where they are normally found.

Useful Wild Plants in Australia, A. B. and J. W. Cribb, Collins.

An excellent guide to plants that are either edible, medicinal or which can be used in other ways. Good descriptions and comments are to the point.

In addition to the above books State and Federal Government bookstores, as well as offices of State Wildlife services, sell regional maps, walking guides and booklets on fauna and flora of various regions. State museums also sell booklets on both flora and fauna.

Index

- abseiling 31, 32
- Adirondack pack 149
- anchor, for peg 40
- anchor, for rope 39
- ants 262
- Arizona survival still 223

- baking on hot stones 122
- bearings 293
- bed, camp 137
- beds, above ground 138
- bench, camp 136
- billy hooks 116
- boiling without utensils 120
- bridge, rope 33-36
- brining 177
- broom 143
- building hints 105
- bulldust 166
- bushfire 246

- camp fires,
 - different types 244-246
- camp, setting up 108
- candle holder 141
- canoe, bark 154
- cardinal points 293
- centipedes 263
- chair, camp 134
- choice of route 273
- circle of declination 300
- climbing, with bush ropes 29-32
- clothes hanger 146
- clothes pegs 143
- clouds 278-281

- contour lines 274
- cooking in clay 124
- coolamon 121
- cord, spinning with fingers 14
- crab net 183
- craypot 188

- declination, circle of 300
- dehydration 288
- dilly bag 147
- direction from stars 307
- direction, obtaining from sun and watch 293
- dish, bark 121
- distance across river, measuring 36
- drying meat 175

- eggs, baked 128
- emergency signal code 287
- equation of time 302

- fire bow drill 238
- fire fighting 247
- fire, correct way to light 227
- fire lighting, by compression 241
 - by friction 238
 - from a coal 230
 - from a spark 236
 - in rain 118
 - with a magnifying glass 237
 - without matches 234
- fire, smokeless 231
- fireplace, camp 112
- firewood 232

- first-aid kit 267
- fish 193-205
- fish traps 180-188
- fish, raw 199
- fishing hooks 189
- fishing spears 190
- flashing 97
- food from trees 210
- food preservation 174
- footlock 29-31
- forks 109
- fungi 214
- furniture, camp 129
- fuzz sticks 119, 228

- Greenwich mean time 304
- grubs, as food 205
- guttering 95

- hammock 140
- hangi 126
- health 157
- hoe 143
- hooks 109
- hooks, fishing 189
- hut, doors and windows 81
 - long 80
 - permanent lean-to 75
 - pyramidal 79
 - round 76
 - sectional lean-to, 73
- huts, thatched 71
- hypothermia 286

- kitchen, camp 110
- knots, fancy 57-63
 - for fastening ropes 50-57
 - for joining ropes 44-46
 - for loops 47-49
 - for rope ends 43-44
- ladder 140
- lamp, slush 141
- larder, camp 145

- lashings 64-65
- leeches 261
- log cabin 103
- logging a route 270
- longitude corrections 304
- luau 126

- map reading 274
- map references 274
- maps 268
- meat, brining 177
 - drying or smoking 175
 - freezing 179
 - preserving in fat 177
- mushrooms 214

- netting 69
- north, finding without compass or, watch 294

- oven, stone 122

- packs 149-150
- pannier pack 150
- pegs 108
- pit cooking 126
- plaiting 22-28
- plotting a course 268
- poison, treatment for 265

- raft 153
- rammed earth construction 97
 - forms and moulds 101
 - foundations 99
 - soil qualities 99
 - strengthening material 100
- river, crossing 151
- river crossing, safety line for 38
- road train 167
- rope bridge 33-36
- rope ladder, single with chocks 33
 - single with sticks 32
- rope-making, common faults 22
 - feeding 21

- gathering and preparing materials 12
 laying the strands 17
 materials 10
 thickness of strands 21
 with single spinner 21
 ropes and cords, making 9
 ropes, breaking strains 10
 ropewalk 16
 ropewalk, construction 18
 route, choice of 273
- sea creatures 263
 shellfish 200
 signal code, emergency 287
 sled 144
 slush lamp 141
 smoking meat 175
 snake bite, treatment of 257
 snakes 254-258
 South Pole 308
 Southern Cross 308
 spears, fishing 190
 spider bite, treatment of 257
 spiders 258
 splices 66-68
 standard time 304
 star charts 310-312
 sun clock 168, 275
 sun compass 275
 sun movement 291
 sun, height above horizon 301
 path through sky 299
 survival 284-289
 swag 147-149
- table, camp 129
 thatching, materials 85
 methods 86
 principles of watershed 86
- ridge 94
 sewn 88
 sewn batten 93
 split stalk 91
 stalk 91
 stick 89
 tuft 90
 woven 92
- ticks 259
 time 306
 time, calculating with sun and compass 291
 calculating without compass 299
 equation of 302
 from stars 309
 Greenwich mean 304
 standard 304
 tinder 235
 toilet, camp 160
 tracks 249
 tracks, bird 251, 252
 mammal 253, 254
 tree swing shelter 83
- vegetables, wild 207
 vehicles, in the bush 160-167
- walking speeds 271
 water from vegetable sources 21
 water in emergencies 215
 water, filtering 128
 indications of 217
 stagnant 224
 weather patterns 281-283
 weather signals 278
 whipping 68
 windlass 41
 witchetty grubs 206
 woodshed, camp 117

320

C11 A175225 012 05

CAMBERWELL CITY LIBRARIES

